

Water System Design Manual



DOH Pub 331-123
Revised October 2019

Acknowledgments

This is the fourth edition of the *Water System Design Manual*. Many Department of Health (DOH) employees provided valuable insights and suggestions to this publication. In particular, we are proud to recognize the members of the group at the Office of Drinking Water who worked over many months to revise this edition of the design manual:

- Andy Anderson
- Jeff Johnson
- Nancy Feagin
- Scott Mallery
- Derek Pell
- Sam Perry
- Scott Torpie, Primary Author
- Linda Waring, Technical Editor

We are especially indebted to the drinking water professionals who contributed their time and expertise to reviewing drafts and providing helpful suggestions. We received extensive input from the following people:

- Aziz Alfi (Seattle Public Utilities)
- Frank Baird (DOH)
- Stephen Baker (DOH)
- William Bernier (DOH)
- David Brown (Washington State Parks)
- Alex Chen (Seattle Public Utilities)
- Steve Deem (DOH)
- Terry Englehardt (Hach Company; retired)
- Melinda Friedman (Confluence Engineering Group LLC)
- Bill Heubach (Seattle Public Utilities)
- Sheryl Howe (DOH)
- Todd Krause (Northwest Water Systems)
- Doug Lane (City of Bellevue)
- Jolyn Leslie (DOH)
- Melanie Mankamyer (Wilson Engineering)
- Mathew Martinson (Indian Health Service; currently at USEPA Region 10)
- Kevin O'Neil (Washington Water Service)

- Doug Piehl (Northwest Water Systems)
- Ryan Peterson (RH2 Engineering)
- John Puccinelli (Washington Water Service)
- Barney Santiago (RH2 Engineering)
- Brian Smith (Wilson Engineering)
- Jeff Sutton (Erlandsen & Associates)
- Ryan Withers (RH2 Engineering)

For more information

Our publications are online at doh.wa.gov/drinkingwater.

Contact our nearest regional office from 8 AM to 5 PM, Monday through Friday. If you have an after-hours emergency, call 877-481-4901.

[Eastern Region](#), Spokane Valley 509-329-2100.

[Northwest Region](#), Kent 253-395-6750.

[Southwest Region](#), Tumwater 360-236-3030.

Table of Contents

Chapter 1: Introduction	1
1.0 Purpose and Scope.....	1
1.1 Safety, Risk, and Reliability	1
1.2 Applying the Group A Rule	2
1.3 "Must" versus "Should"	3
1.4 Engineering Requirements	4
1.5 Minimum System Design Requirements.....	4
1.6 Other Referenced Documents and Standards	4
Chapter 2: Project Reports and Construction Documents	6
2.0 General Engineering Project Submittal Requirements	6
2.1 Project Reports, Construction Documents, and Planning Requirements	6
2.2 Submitting Project Reports and Construction Documents.....	7
2.3 Relationship between Project Approval and Operating Permit	8
2.4 Project Reports.....	8
2.4.1 Project Description.....	9
2.4.2 Planning.....	9
2.4.3 Analysis of Alternatives.....	10
2.4.4 Water Quality.....	10
2.4.5 Engineering Calculations	11
2.4.6 Design Criteria.....	11
2.4.7 Water Rights and Other Legal Considerations.....	11
2.4.8 Operations and Maintenance Considerations	13
2.4.9 State Environmental Policy Act Requirements	13
2.5 Construction Documents	13
2.5.1 Design Drawing Requirements	14
2.5.2 Project Specifications.....	15
2.5.3 Design Changes after Project Approval.....	15
2.5.4 Contractor-Supplied Design Components	16
2.6 Coordination with Local Approving Authorities.....	17
2.7 Design and Review Process.....	17
2.8 Submittal Exceptions for Miscellaneous Components and Distribution Mains	17
2.8.1 Categorically Exempt.....	17
2.8.2 Exempt Distribution Main Projects	18
2.9 Submittal Exception: Distribution-Related Projects (not Distribution Mains).....	18
2.9.1 Design and Construction Standards for Reservoirs and Booster Pump Stations	22
2.9.2 Rescinding Submittal Exception Authority.....	23
2.10 Resolving Disputed Department of Health Review Decisions	23
2.11 Review Fees and Invoice.....	24
2.12 Project Approval Letter and Construction Completion	24
2.13 Construction Completion Report Forms	24
2.14 Record Drawings	25
2.15 Safety	25

Chapter 3: Estimating Water Demands.....27

3.0	Applicability.....	27
3.1	Demand versus Consumption.....	27
3.2	Consumer Demand	28
3.2.1	<i>Evaluating Actual Water Demand</i>	29
3.2.2	<i>Full-Time and Part-Time Single-Family Residential Users</i>	30
3.2.3	<i>Analogous Water Systems</i>	32
3.2.4	<i>DOH Default Water Demand Design Criteria (Appendix D)</i>	33
3.3	Water System Demand	34
3.4	Estimating Water System Demands.....	35
3.4.1	<i>Maximum Day Demand</i>	35
3.4.2	<i>Peak Hourly Demand (PHD)</i>	36
3.5	Anticipating Changes in Demand: Systems with Mostly Residential Demand	38
3.5.1	<i>Referencing Data from Prior Years</i>	38
3.5.2	<i>Commercial, Industrial, and Public Facilities</i>	39
3.6	Estimating Nonresidential Water System Demand.....	40
3.6.1	<i>Procedures for Estimating Nonresidential Demands</i>	41
3.6.2	<i>Commercial, Industrial and Public Facility Demand</i>	43
3.6.3	<i>Farming and Crop Irrigation Demand</i>	44
3.6.4	<i>Recreational Development Demand</i>	45
3.6.5	<i>Anticipating Changes in Demand: Systems with Mostly Nonresidential Demand</i>	47
3.7	Establishing Needed Fire Flow	48
3.8	Factoring Distribution System Leakage (DSL) in Design.....	48
3.9	Water Resource Issues	50
3.10	Source Adequacy and Reliability.....	50
3.10.1	<i>Design and Operating Requirements</i>	50
3.10.2	<i>Surface Water Source Reliability</i>	50
3.10.3	<i>Groundwater Source Reliability</i>	51
3.10.4	<i>General Safety Factor and Contingency Planning</i>	52
3.10.5	<i>Summary of Water Supply Reliability Recommendations</i>	52
3.11	Factor of Safety.....	53
3.12	Example Exercises for Estimating Water System Demand	53
3.12.1	<i>New Community Water System</i>	53
3.12.2	<i>Expanding (Existing) Community Water System</i>	54
3.12.3	<i>New Mixed-Use Community Water System</i>	56
3.12.4	<i>Expanding Mixed-Use Community Water System</i>	57
3.12.5	<i>Expanding Noncommunity Water System</i>	60
3.12.6	<i>Assessing Full- and Part-Time Residential Use</i>	61

Chapter 4: Water System Capacity Analysis 66

4.0	Introduction.....	66
4.1	General Expectations	67
4.2	ERUs, Connections, and Population.....	67
4.2.1	<i>ERUs</i>	67
4.2.2	<i>Connections Served</i>	68
4.2.3	<i>Population Served</i>	69

4.3	Applying the Concept of Equivalent Residential Units in Design.....	69
4.4	Determining Water System Capacity.....	71
4.4.1	Step 1: Water Demands.....	71
4.4.2	Step 2: Source Capacity.....	71
4.4.2.1	Water Rights.....	72
4.4.2.2	Pumping Tests and Groundwater Reliability.....	73
4.4.2.3	Surface Water (Watershed) Reliability.....	73
4.4.2.4	Installed Pump Capacity.....	74
4.4.2.5	Interties.....	74
4.4.2.6	Treatment Capacity.....	74
4.4.2.7	Determining ERUs based on Source Capacity.....	75
4.4.3	Step 3: Capacity Based on Storage.....	77
4.4.3.1	ERUs Based on Equalizing Storage.....	78
4.4.3.2	ERUs Based on Standby Storage.....	80
4.4.4	Step 4: Capacity Based on Distribution Facilities.....	81
4.4.4.1	ERUs Based on Maintaining Adequate Residual Pressure under PHD Conditions.....	82
4.4.4.2	Fire Flow Effects on Capacity.....	82
4.4.5	Step 5: Factoring DSL into Capacity Analysis.....	83
4.4.6	Step 6: Determine Limiting Criteria and Water System Service Capacity in ERUs.....	83
4.5	Methodology to Determine Water System Capacity.....	84
4.5.1	Step 1: Water Demands.....	84
4.5.2	Step 2: Source Capacity.....	84
4.5.2.1	Water Rights.....	85
4.5.2.2	Pumping Tests and Groundwater Reliability.....	86
4.5.2.3	Surface Water (Watershed) Reliability.....	86
4.5.2.4	Installed Pump Capacity.....	87
4.5.2.5	Interties.....	87
4.5.2.6	Treatment Capacity.....	87
4.5.2.7	Determining Capacity based on Source of Supply.....	88
4.5.3	Step 3: Capacity Based on Storage.....	89
4.5.3.1	Equalizing Storage.....	90
4.5.3.2	Standby Storage.....	90
4.5.4	Step 4: Capacity Based on Distribution Facilities.....	90
4.5.4.1	PHD Conditions.....	91
4.5.4.2	Fire Flow Conditions.....	91
4.5.5	Step 5: Factoring DSL into Capacity Analysis.....	92
4.6	Documenting Nonresidential Water System Capacity.....	92
4.7	Examples of Nonresidential Water System Capacity Analysis.....	92
Chapter 5: Source of Supply.....		106
5.0	Introduction.....	106
5.1	Drinking Water Contaminants.....	106
5.1.1	Initial Sampling Requirements for New Sources.....	107
5.1.2	Detecting Primary Drinking Water Contaminants.....	109
5.1.3	Exceeding the Primary Drinking Water MCL.....	109
5.1.4	Secondary Contaminants.....	110
5.1.5	Groundwater Source Construction-Related Contaminants.....	111

5.1.6	Source Sample Taps	112
5.2	Source Protection.....	112
5.3	Distribution Water Quality Effects from New or Modified Sources.....	113
5.4	Source Water Quantity and Reliability	115
5.5	Wells.....	115
5.5.1	Steps to Take Before Drilling a Well.....	116
5.5.2	Documenting Wellhead Protection	117
5.5.3	Groundwater Pumping Tests	118
5.5.4	Seawater Intrusion.....	119
5.6	Spring Sources	119
5.6.1	Spring Source Safe Yield.....	120
5.6.2	Spring Source Water Quality.....	120
5.7	Groundwater under the Direct Influence of Surface Water	121
5.8	New Surface Water Supplies.....	122
5.8.1	Surface Water Safe Yield.....	124
5.9	Purchased Water and Emergency Interties	124
5.9.1	Reliability of Purchased Water (Nonemergency Interties)	125
5.9.2	Emergency Interties.....	127
5.10	Unconventional Sources.....	128
5.10.1	Rainwater Collection	128
5.10.2	Trucked and Hauled Water.....	129
5.10.3	Desalination	129
5.10.4	Aquifer Storage and Recovery.....	129
5.11	General Source Design Considerations	130
5.11.1	Power Supply Reliability	130
5.11.2	Criteria for Multiple Sources or Multiple Pumps per Source.....	131
5.12	Water Resource Analysis and Water Rights.....	132
5.12.1	Temporary Water Rights.....	132
5.12.2	Interruptible Water Rights.....	132
5.12.3	Leased Water Rights.....	133
5.13	Placing a New or Modified Source into Service	134
Chapter 6: Transmission and Distribution Main Design		140
6.0	Introduction.....	140
6.1	Hydraulic Analysis.....	141
6.1.1	Data Collection.....	142
6.1.2	Hydraulic Model Development.....	143
6.1.3	Hydraulic Model Calibration.....	143
6.1.4	Hydraulic Model Analysis.....	146
6.1.5	Extended Period Simulation	148
6.1.6	Hydraulic Transients (Water Hammer).....	148
6.2	Sizing Pipelines	149
6.2.1	Sizing Procedures.....	149
6.2.2	Minimum Size.....	149
6.2.3	Peak Hourly Demand.....	150
6.2.4	Fire "Suppression" Flow.....	150
6.2.5	Minimum Distribution System Pressure.....	151

6.2.6	<i>Maximum Velocity</i>	151
6.2.7	<i>Excess Pressure</i>	152
6.2.8	<i>Surge and Transient Control</i>	152
6.2.9	<i>Assessing Water Quality Effects on the Existing Distribution System</i>	153
6.3	General Design Considerations for Mains	153
6.3.1	<i>Installation</i>	154
6.3.2	<i>Depth of Pipe Burial</i>	154
6.3.3	<i>Special Design Considerations</i>	155
6.3.4	<i>Separation from Nonpotable Conveyance Systems</i>	155
6.3.5	<i>Separation from Other Potential Sources of Contamination</i>	156
6.3.6	<i>Pipe Materials</i>	157
6.3.7	<i>External Corrosion Control</i>	157
6.3.8	<i>Location of Pipes in Geologically Vulnerable Areas</i>	158
6.3.9	<i>Layout of Mains</i>	159
6.3.10	<i>Protection Against Cross-Connection</i>	160
6.4	Appurtenant Design Considerations	161
6.4.1	<i>Valves</i>	161
6.4.2	<i>Vacuum Relief and Air Release Valves</i>	161
6.4.3	<i>Flushing Valves, Blow-offs and Hydrants</i>	163
6.4.4	<i>Fire Hydrants</i>	163
6.4.5	<i>Sampling Stations</i>	163
6.4.6	<i>Yard Hydrants</i>	164
6.4.7	<i>Angle, Curb or Meter Stops</i>	164
6.4.8	<i>Individual Pressure-Reducing Valves</i>	164
6.4.9	<i>Automatic Control Valves</i>	165
6.5	Construction Documents for Pipelines	165
6.5.1	<i>Construction Specifications for Pipelines</i>	166
6.6	Placing a Water Main into Service	166

Chapter 7: Reservoir Design and Storage Volume 171

7.0	Introduction	171
7.1	Reservoir Sizing	172
7.1.1	<i>Storage Components</i>	172
7.1.1.1	<i>Operational Storage</i>	172
7.1.1.2	<i>Equalizing Storage</i>	176
7.1.1.3	<i>Standby Storage</i>	177
7.1.1.4	<i>Fire Suppression Storage</i>	179
7.1.1.5	<i>Dead Storage</i>	180
7.1.2	<i>Storage Used for Treatment Purposes</i>	181
7.1.3	<i>Source Definition Used in Sizing New Reservoirs</i>	181
7.1.4	<i>Storage for Consecutive Water Systems</i>	182
7.1.5	<i>Storage for Noncommunity Water Systems</i>	183
7.2	Geometry, Elevation, and Integration with Existing and Future Facilities	184
7.2.1	<i>Establishing Overflow Elevations</i>	184
7.3	Location and Site Considerations	185
7.3.1	<i>Natural Hazard Considerations</i>	186
7.4	Construction Materials and Design Elements	187

7.4.1	<i>Partially Buried and Underground Reservoirs</i>	188
7.4.2	<i>Piping and Appurtenances - General</i>	189
7.4.3	<i>Reservoir Drains</i>	189
7.4.4	<i>Reservoir Overflows</i>	190
7.4.5	<i>Reservoir Atmospheric Vents</i>	191
7.4.6	<i>Access Hatches</i>	193
7.4.7	<i>Roof Drainage</i>	194
7.4.8	<i>Reservoir Security</i>	194
7.5	Operational Constraints and Considerations	194
7.5.1	<i>Reservoir Valves</i>	195
7.5.2	<i>Reservoir Level Control</i>	195
7.5.3	<i>Backup Power Facilities</i>	195
7.6	Reservoir Water Quality and Sampling Access	195
7.6.1	<i>Water Circulation and Stagnation</i>	196
7.6.2	<i>Tank Materials in Contact with Potable Water</i>	197
7.7	Placing a Reservoir into Service	198
	Chapter 8: Booster Pump Station Design	202
8.0	Introduction	202
8.1	Booster Pump Station Capacity	202
8.1.1	<i>Open System Booster Pump Station Sizing Guidelines</i>	203
8.1.2	<i>Closed System Booster Pump Station Sizing Guidelines</i>	204
8.1.3	<i>Fire Flow Requirements for Pump Stations in Coordination Act Areas</i>	205
8.1.4	<i>Flow Control for Booster Pump Stations</i>	205
8.2	General Booster Pump Station Site Considerations	206
8.2.1	<i>Natural Hazard Considerations</i>	207
8.3	Booster Pump Station Design Details	208
8.4	Individual Booster Pumps	210
8.4.1	<i>Cross-Connection Control for Individual Booster Pumps</i>	211
8.5	Placing a Booster Pump Station into Service	211
	Chapter 9: Pressure Tanks	213
9.0	Introduction	213
9.1	Pressure Tank Sizing	213
9.1.1	<i>Bladder Tank Sizing</i>	214
9.1.2	<i>Bladder Tank Design Procedures</i>	214
9.1.3	<i>Hydropneumatic Tank Sizing Equations (bottom outlet)</i>	216
9.1.4	<i>Hydropneumatic Tank Design Procedures</i>	217
9.1.5	<i>Reduced Pressure Tank Sizing</i>	221
9.2	Labor and Industries Standards for Pressure Tanks	222
9.3	Locating Pressure Tanks	223
9.4	Piping	223
9.5	Hydropneumatic Pressure Tank Appurtenances	223
9.6	Pressure Tank Sizing - Examples	224
	Chapter 10: General Water Treatment	226

10.0	Introduction.....	226
10.1	Alternatives Analysis	227
10.1.1	Source Water Quantity.....	228
10.1.2	Source Water Quality.....	228
10.1.3	Secondary Effects of Water Treatment	229
10.1.4	Operations and Maintenance Considerations.....	230
10.1.5	Treatment Plant Waste Disposal	231
10.1.6	Life Cycle Cost Analysis.....	231
10.1.7	General Water Treatment Plant Site Considerations	232
10.1.7.1	Natural Hazard Considerations	233
10.1.8	Variances.....	234
10.2	Treatment Technologies.....	235
10.2.1	Disinfection.....	236
10.2.1.1	Source Water Quality.....	237
10.2.1.2	Primary Disinfection of Groundwater Sources.....	237
10.2.1.3	Secondary Disinfection of Distribution Systems	238
10.2.1.4	Monitoring Plans	239
10.2.1.5	Disinfection of Seawater or Brackish Water Source.....	239
10.2.1.6	Alternative Disinfectants.....	240
10.2.2	Disinfection Byproducts.....	241
10.2.3	Fluoridation	244
10.2.4	Corrosion Control.....	245
10.2.5	pH Adjustment.....	246
10.2.6	Inorganic Chemicals.....	247
10.2.6.1	Arsenic.....	247
10.2.6.2	Nitrate and Nitrite	249
10.2.6.3	Iron and Manganese	250
10.2.6.4	Fluoride Removal.....	252
10.2.7	Volatile Organic Chemicals and Synthetic Organic Chemicals.....	252
10.2.8	Radionuclides.....	252
10.2.9	Emerging and Unregulated Contaminants.....	252
10.3	Predesign Studies.....	253
10.3.1	Pilot Studies.....	253
10.3.2	Pilot Study Duration.....	254
10.3.3	Pilot Study Plan (Protocol)	255
10.3.4	Pilot Study Report.....	257
10.3.5	Full Scale Pilot Study.....	257
10.4	Project Reports.....	258
10.4.1	Design Criteria and Facility Design	259
10.4.2	Process Control—Monitoring, Instrumentation and Alarms	259
10.4.3	Operations, Start-up, and Testing	263
10.4.4	Treatment System Reliability	265
10.5	Construction Documents	266
10.6	Treatment Chemicals	266
10.6.1	Chemical Overfeed Prevention and Feed Systems	266
10.6.2	Safe Chemical Storage and Handling.....	268
10.7	Cross-Connection Control for Water Treatment Facilities	270

10.7.1	<i>Premises Isolation</i>	270
10.7.2	<i>Cross-Connection Control inside the Water Treatment Plant</i>	271
10.7.3	<i>Other Design Considerations</i>	273
10.7.4	<i>Common Wall Construction in Treatment Facilities</i>	273
10.8	Water Treatment Plant Wastewater Disposal.....	275
10.9	Placing a Water Treatment Plant into Service.....	279
Chapter 11: Surface Water Treatment		297
11.0	Introduction.....	297
11.1	Alternatives Analysis	298
11.1.1	<i>Source Capacity and Projected Demands</i>	299
11.1.2	<i>Source Water Protection</i>	299
11.1.3	<i>Source Water Quality</i>	300
11.1.4	<i>Operational Complexity and Staffing</i>	302
11.2	Treatment Technologies.....	303
11.2.1	<i>Screening and Prefiltration</i>	304
11.2.2	<i>Chemical Addition</i>	304
11.2.3	<i>Clarification and Sedimentation</i>	305
11.2.4	<i>Filtration</i>	307
11.2.5	<i>Disinfection</i>	311
11.2.5.1	<i>Determining Disinfection Efficacy</i>	312
11.2.5.2	<i>Disinfection Profiling and Benchmarking</i>	314
11.3	Predesign Studies.....	315
11.3.1	<i>Pilot Studies</i>	315
11.3.2	<i>Pilot Study Duration</i>	316
11.3.3	<i>Pilot Study Plan and Report</i>	316
11.4	Project Reports.....	316
11.4.1	<i>Design Criteria</i>	318
11.4.2	<i>Process Control: Monitoring, Instrumentation and Alarms</i>	318
11.4.3	<i>Start-up and Testing</i>	320
11.4.4	<i>Treatment Plant Operations and Staffing</i>	321
11.4.5	<i>Process Reliability</i>	323
11.5	Operations Program	326
11.6	Placing a Surface Water Treatment Plant into Service.....	328
Appendix A: Forms, Policies, and Checklists.....		335
Appendix A.1	Forms.....	336
Appendix A.2	Policies	337
Appendix A.3	Project Checklists	338
Appendix A.3.1	<i>General Project Report Checklist</i>	339
Appendix A.3.2	<i>Groundwater Source of Supply Checklist</i>	340
Appendix A.3.3	<i>Transmission and Distribution Main Checklist</i>	343
Appendix A.3.4	<i>Hydraulic Analysis Checklist</i>	345
Appendix A.3.5	<i>Reservoir Checklist</i>	347
Appendix A.3.6	<i>Booster Pump Station Checklist</i>	350
Appendix A.3.7	<i>Pressure Tank Checklist</i>	352
Appendix A.3.8	<i>Water Treatment Facilities Checklist</i>	353

Appendix B: Selected Guidelines	357
Appendix B.1 Well Field Designation and Source Sampling Guidelines.....	358
Appendix B.2 Pump Cycle Control Valve Guidelines.....	361
Appendix B.3 Variable Frequency Drive Pumps and Motors	365
Appendix B.4 Tracer Study Checklist.....	367
Appendix C: List of Agencies and Publications.....	372
Appendix D: Estimating Water Demands	377
Appendix D.1 Background: Residential Water Demand vs. Precipitation	378
Appendix D.2 Estimating Nonresidential Demand	389
Appendix D.3 MDD vs. Maximum Month Average Daily Demand.....	391
Appendix E: Recommended Pumping Test Procedures.....	393
1.0 Introduction.....	393
2.0 Basic Approach to Pumping Tests	394
2.1 Step-Drawdown Pumping Test.....	394
2.2 Constant-rate Pumping Test.....	395
2.2.1 <i>Recovery Phase</i>	395
3.0 Planning a Pumping Test	396
3.1 Well Site Description.....	396
3.2 Well Construction and Condition	397
3.3 Data	397
3.4 Pumping Test Mechanics and Field Procedure.....	398
4.0 Recommended Pumping Test Methods and Procedures.....	398
4.1 Stabilized Drawdown	398
4.2 Observation Wells.....	399
4.3 Test Duration	399
4.3.1 <i>Step-Drawdown Test</i>	399
4.3.2 <i>Constant-Rate Test</i>	400
4.4 Pumping Rate.....	400
4.4.1 <i>Step-Drawdown Test</i>	400
4.4.2 <i>Constant-Rate Test</i>	401
4.5 Water-Level Measurements	401
4.5.1 <i>Step-Drawdown Test</i>	402
4.5.2 <i>Constant-Rate Test</i>	402
4.5.3 <i>Recovery Data</i>	403
4.6 Surface Water	403
4.7 Conveying Pumped Water.....	403
5.0 Concerns in Special Aquifer Settings.....	404
5.1 Low-Flow Conditions	404
5.2 Fracture Flow.....	404
5.3 Aquifer of Limited Areal Extent.....	405
5.4 Seawater Intrusion	405
5.5 Multiple Wells and Well Fields	406

5.6	Groundwater Wells Potentially Under the Direct Influence of Surface Water	407
6.0	Pumping Test Results	407
6.1	Pumping Rate Determination.....	407
6.2	Pump Setting	408
6.3	Safety Factor	408
7.0	Reporting	408
7.1	Pumping Test Data Presentation.....	409
8.0	Potable-Water Supply Samples	410

Appendix F: Submittal Outlines for Select Water Treatment Processes..417

Appendix F.1	Hypochlorination for Small Water Systems	418
F.1.1	General Water System Information.....	418
F.1.2	Description of the Water Quality Problem	418
F.1.3	Raw Water Quality.....	419
F.1.4	Hypochlorination System Details.....	421
F.1.5	Hypochlorination Feed Pump Requirements	421
F.1.6	Hypochlorination Feed Pump Specifications.....	422
F.1.7	Solution Tank Sizing	423
F.1.8	Achieving 4-log Virus Inactivation (CT6) Treatment.....	423
F.1.9	Checklist of Additional Items	424
Appendix F.2	Fluoride Saturator, Upflow Type	426
F.2.1	General Water System Information.....	426
F.2.2	Description of the Treatment Objective.....	426
F.2.3	Fluoridation System Details	426
F.2.4	Fluoridation Feed Pump Requirements.....	427
F.2.5	Fluoridation Feed Pump Specifications.....	428
F.2.6	Solution Tank Sizing	428
F.2.7	Make-up Water Supply and Cross-Connection Control.....	428
F.2.8	Overfeed Protection	429
F.2.9	Checklist of Additional Items.....	429
Appendix F.3	Arsenic Removal by Coagulation/Filtration	431
F.3.1	General Water System Information.....	431
F.3.2	Description of the Water Quality Problem	431
F.3.3	Raw Water Quality.....	432
F.3.4	Pilot Testing	433
F.3.5	Summarize Coagulation-Filtration Treatment Components	433
F.3.6	Full-Scale Design.....	434
F.3.7	Operations and Maintenance.....	436
Appendix F.4	Arsenic Removal by Adsorbents	438
F.4.1	General Water System Information.....	438
F.4.2	Description of the Water Quality Problem	438
F.4.3	Raw Water Quality.....	438
F.4.4	Pilot Testing	439
F.4.5	Summarize Adsorbent Treatment Components.....	440
F.4.6	Full-Scale Design.....	440
F.4.7	Operations and Maintenance.....	443
Appendix F.5	Use of Ozone in Groundwater Treatment	444

F.5.1	Raw Water Quality.....	444
F.5.2	Pilot Plant Testing.....	444
F.5.3	Full-Scale Design.....	444
F.5.4	Operations and Maintenance.....	446
Appendix F.6	Reverse Osmosis for Desalination of Seawater or Estuarine Water.....	448
F.6.1	General Water System Information.....	448
F.6.2	Permitting (verify with local, state, tribal and federal agencies)	448
F.6.3	Pilot Study.....	449
F.6.4	Project Report.....	449
F.6.5	Operations and Maintenance Manual	452
F.6.6	Other Design Considerations.....	452
Appendix F.7	Rainfall Catchment Submittal Requirements.....	453
Appendix F.8	Rainfall Catchment Reliability Analysis – Example.....	455
Appendix F.9	Iron and Manganese Treatment by Oxidation Filtration.....	459
F.9.1	General Water System Information.....	459
F.9.2	Description of the Water Quality Problem	460
F.9.3	Raw Water Quality.....	460
F.9.4	Pilot Testing	461
F.9.5	Summarize Oxidation-Filtration Treatment Components	461
F.9.6	Full-Scale Design.....	462
F.9.7	Operations and Maintenance.....	464
Appendix F.10	Iron and Manganese Treatment by Sequestration.....	466
F.10.1	Design Limitations	466
F.10.2	Pilot Testing for Sequestering – Laboratory Bench Scale Tests.....	467
F.10.3	Public Notification	468
F.10.4	Distribution System Related Problems.....	468
Appendix F.11	Nitrate Removal by Ion Exchange.....	470
F.11.1	General Water System Information.....	470
F.11.2	Description of the Water Quality Problem.....	470
F.11.3	Raw Water Quality	470
F.11.4	Pilot Testing.....	472
F.11.5	Summarize Ion Exchange Treatment Components.....	472
F.11.6	Full-Scale Design	473
F.11.7	Operations and Maintenance	475
Appendix G:	Guidance for Leachable Contaminants Testing.....	476
Appendix H:	Slow Sand Filtration	481
Appendix I:	Ultraviolet Disinfection.....	493

Chapter 1: Introduction

1.0 Purpose and Scope

The Department of Health Office of Drinking Water (DOH) developed this *Water System Design Manual* to establish uniform concepts for water system design and a framework for state-licensed engineers to consistently review design documents. This manual is for Group A public water systems regulated under the federal Safe Drinking Water Act and state law (Chapter 246-290 WAC.) We developed separate [design guidelines for Group B public water systems](#), which are so small that only state law regulates them (Chapter 246-291 WAC).

This manual provides guidelines and criteria for design engineers to use in preparing portions of planning documents (WAC 246-290-100), project reports (WAC 246-290-110), construction documents (WAC 246-290-120), and source approval documents (WAC 246-290-130). This manual also clarifies engineering document submittal and review requirements. Most of the requirements in this manual apply to Group A water systems of all sizes. However, some of the design guidelines, such as the information on demand estimation and capacity analysis in chapters 3 and 4, focus more on water systems serving fewer than 1,000 connections.

1.1 Safety, Risk, and Reliability

Our mission is to work with others to protect the health of the people of Washington state by ensuring safe and reliable drinking water. We believe water system owners, operators, and design engineers share this mission.

This manual identifies design requirements and design standards for ensuring safe and reliable drinking water sources and facilities. Where this manual doesn't simply restate a regulatory requirement, it reflects our best thinking on what constitutes the basis for designing a safe, reliable, and sustainable water system—one that does not result in exhausted water sources, empty reservoirs, premature equipment breakdowns, contamination, low service pressures, or destructive pressure surges. While establishing these standards, we attempted to balance the reduction of risk against the added cost to provide that reduced risk and the capacity of water systems to maintain the associated physical and human infrastructure. The State Board of Health's view of a water supplier's responsibility to provide reliable water service is in WAC 246-290-420.

A Washington state-licensed professional engineer **must** direct all water system design work and all design documents **must** bear the professional engineer's seal, date, and signature (WAC 246-290-040). Our state-licensed professional engineers review engineering documents with a focus on risk reduction and public health protection. In reviewing engineering documents, we intend to ensure compliance with regulatory standards. We also strive to share our collective experience to promote construction and operation of appropriate, safe, reliable, and sustainable public water supply systems. Our ultimate goal is to help the design engineer and water system owner build a project that will be safe and reliable now and into the future. We do this by asking questions, exploring risk versus available resources in the design phase, and helping water system owners and design engineers identify potential consequences of operational failure (e.g. contamination leading to illness, effects of health advisories, permit restriction, or legal liability).

Design engineers need to know what we think are appropriate design standards, but they also need flexibility to approach the unique design circumstances they face. We encourage design engineers to consider various alternatives and options, as long as the selected approach does not conflict with regulation. If the designer's selected approach differs from our standards, we expect the design engineer to justify their design decisions for us.

We are interested in hearing from readers who believe we misjudged the balance point between cost and public health protection. Please contact one of our [regional offices](#) with any comments or questions. We periodically review and update our design guidance as appropriate.

1.2 Applying the Group A Rule

Our Group A Rule applies to all water systems that regularly serve 15 or more service connections or 25 or more people per day for 60 or more days per year. Definitions of Group A public water system types (community, nontransient noncommunity, transient noncommunity) are in WAC 246-290-020. A water system, such as that serving people within a large building, is not subject to our rules if the building's water system meets all the following criteria:

1. It consists only of distribution or storage facilities without source or treatment facilities.
2. It obtains all its water from another regulated water system.
3. It is not an interstate passenger conveyance carrier.
4. It does not sell water directly to any person.

EPA issued [policies](#) to clarify whether the Safe Drinking Water Act applies in certain situations. Based on our review of these policies:

- Submetering individual dwelling units within a larger multifamily building does not trigger regulation (chapter 246-290 WAC). We do not consider apartment owners who install meters (submeters) and bill their tenants for actual water consumption as water systems subject to regulation.
- Installing treatment within a building that serves 25 or more people per day for 60 or more days per year does trigger regulation (chapter 246-290 WAC). However, depending on the purpose and type of treatment, and the size and type of population served, we may not require regulation of the building as a public water system. Please contact one of our [regional offices](#) for guidance.

We have [policies](#) to clarify and interpret state drinking water regulations. When we published this manual, we had a number of policies that may influence water system design and planning. We attempted to reference our policies in applicable sections of this manual. Because we may add new policies and revise or rescind existing policies, we encourage you to review our [policy webpage](#) to determine whether any current policies apply to your design.

Many water systems were built before the current minimum design requirements were established in chapter 246-290 WAC. Design engineers **must** use the most recent standards and guidelines when designing new facilities or in planning expansion of an existing system (WAC 246-290 Part 3).

1.3 “Must” versus “Should”

Throughout this manual we use “**must**,” “**will**,” “**shall**,” or “**required**” when design practice is sufficiently standardized to permit specific delineation of requirements, or where safeguarding public health justifies definitive criteria or action (such as state statute or rule requirements). Design engineers have an obligation to satisfy the criteria in such instances.

“Should” or “recommend” indicate procedures, criteria, or methods that represent our view of best practices and can be approached with some degree of flexibility. Design engineers need to explain the basis of the altered approach or, in specific circumstances, why another approach may be more applicable.

1.4 Engineering Requirements

Only Washington state-licensed professional engineers qualified and experienced in design of drinking water systems may design water systems in our state (Chapter 18.43 RCW and WAC 246-290-040). There is a limited exception for federal employees who practice engineering in Washington state for the federal government and who possess a valid professional engineer's license from another state (RCW 18.43.130(6)).

Engineers are professionally bound to perform work only within their own fields of competence (WAC 196-27A-020(2)). Complex drinking water projects usually require structural, electrical, mechanical, and other licensed professional engineers.

1.5 Minimum System Design Requirements

Design engineers **must** use good engineering practice (as determined by the Washington State Professional Licensing Board) in all aspects of water system design (WAC 246-290-200). The design engineer **must** consider the water system operation under a full range of expected demands (minimum to maximum) and emergency conditions (WAC 246-290-420). "Emergency" means a natural or man-made event that causes damage or disrupts normal operations and requires prompt action to protect public health and safety. Examples include fires, power outages, water main breaks, water system component or treatment process failures, floods, or recent evidence of contaminated drinking water.

1.6 Other Referenced Documents and Standards

We cite various waterworks-related laws, guides, standards, and other documents in this manual to provide appropriate references. These references form a part of this manual, but it is not our intent to duplicate them. If references are not available, this manual defines the appropriate design procedures.

There are some waterworks industry standards and guidance documents, such as those from the American Water Works Association (AWWA), the American Society of Civil Engineers (ASCE), and *Recommended Standards for Water Works* (commonly called the Ten State Standards). If information in this manual conflicts with any referenced material, this manual should take precedence for purposes of designing water system facilities to meet our requirements. We will request that the design engineer provide adequate justification for deviation from guidelines in this manual when submitting the project design to us for review and approval.

Where applicable, all water system designs also **must** comply with locally adopted national model codes such as the *International Building Code* and *Uniform Plumbing Code* (WAC 246-290-200).

See Appendix C for a list of professional organizations and agencies with established standards and criteria referenced within this manual or the regulations.

Chapter 2: Project Reports and Construction Documents

2.0 General Engineering Project Submittal Requirements

Chapter 2 provides information to assist design engineers in preparing complete engineering documents to submit for our review and approval. Complete, concise, accurate submittals enable us to work efficiently and to meet our target review timeframe. We strive to complete our initial review of project reports and construction documents within about 30 days. Incomplete submittals will delay the formal start of our review process.

Incomplete project submittals will result in delayed project review and may result in increased review fees (due to the need for multiple reviews). We will return significantly incomplete or inaccurate submittals to engineers without reviewing them. This manual includes submittal checklists for many common projects. We suggest you reference them before submitting your final design to us for approval. Doing so will help ensure timely and efficient review of your submittal.

A complete submittal:

1. Includes a completed [Project Approval Application Form](#) (DOH 331-149-F).
2. Addresses all relevant elements identified in regulation and this manual.
3. Articulates information clearly, concisely, and logically.

2.1 Project Reports, Construction Documents, and Planning Requirements

Water systems satisfy planning requirements in Chapter 246-290 WAC by preparing a water system plan (WSP) or a small water system management program (SWSMP). The conditions under which a water system **must** prepare a WSP or WSP amendment for our review and approval are in WAC 246-290-100. Water systems not required to prepare a WSP **must** develop and implement a SWSMP (WAC 246-290-105).

These planning documents provide a structured process for water systems to:

1. Identify present and future needs.
2. Set forth means for addressing those needs.
3. Demonstrate the operational, technical, managerial, and financial capacity to achieve and maintain compliance with all relevant local, state, and federal plans and rules.

4. Demonstrate sufficient physical capacity and water rights for current and future needs. Together these comprise system capacity.

The water system planning requirement links closely with water system design. Water systems preparing a WSP **must** assess system capacity, identify deficiencies, and where needed establish an improvement plan necessary to maintain system capacity (WAC 246-290-100). Water systems preparing a SWSMP **must** assess its infrastructure and list improvements associated with current and anticipated infrastructure deficiencies (WAC 246-290-105). Design engineers should reference information in a WSP or SWSMP when preparing a project report for new facilities or modifications to existing facilities.

If a water system contemplates preparing a project report or construction documents and the project is not included in a current, approved WSP, the water system and design engineer should contact one of our [regional offices](#) for guidance on specific planning requirements associated with the project.

A water system may combine project reports (but not construction documents) with a WSP (WAC 246-290-100(3)). If all the information required for a project report (WAC 246-290-110) is in the water system's approved WSP, a separate project report is not required.

2.2 Submitting Project Reports and Construction Documents

Unless a project is otherwise exempt from the project report or construction document submittal process (WAC 246-290-125), a water system proposing to construct any new water system, or expand or improve a water system, **must** first submit a project report (WAC 246-290-110) and construction document (WAC 246-290-120 and [Policy J.21](#)) to us for review and approval. Sections 2.8 and 2.9 describe exceptions to this requirement.

Design engineers should plan to submit engineering documents to us for our approval in paper form. At this time exceptions could be made, in advance, for small documents (small file size) to be submitted electronically. Design engineers should consult with the appropriate DOH review engineer prior to considering an electronic submittal.

If the construction documents will be part of a bidding package, we recommend design engineers submit construction documents in time to complete the review before bid solicitation starts. We expect to take about 30 calendar days to review construction documents, measured from the date we receive a complete submittal. If the design

engineer fails to obtain approval prior to soliciting bids, the water system may have to solicit new bids or deal with significant change orders or contract amendments.

If the initial review results in a comment letter requiring an additional submittal and review cycle before approval, the approval timeline will extend significantly and may result in additional review fees. Comments requiring resubmittal usually involve:

- Incomplete submittals, where basic requirements of the submittal are not met
- Errors and/or omissions
- Lack of clarity or consistency in the design
- Insufficient evidence or justification that the project objective(s) will be met

Anyone who constructs improvements to a water system without getting required prior written approval from us, is subject to administrative penalties (WAC 246-290-050(7)). Contact one of our [regional offices](#) if you are uncertain whether the planned project requires prior written approval.

2.3 Relationship between Project Approval and Operating Permit

Every Group A public water system **must** obtain an annual operating permit (see Chapter 246-294 WAC). Operating permit designations reflect compliance or approval status, or both. Project report and construction document approval does not change a water system's operating permit designation. However, the approval of a WSP or SWSMP, and the approval of construction documents and completion of the associated construction may satisfy requirements necessary to maintain or improve a water system's compliance or approval status, and therefore maintain or change the water system's operating permit designation.

2.4 Project Reports

A project report describes the basis for a project and includes calculations to show how the project will meet its objectives (WAC 246-290-110). Design engineers usually prepare the project report before preparing construction documents. See Section 2.5 and WAC 246-290-120 for construction document requirements. Project reports **must** reflect good engineering criteria and practices (WAC 246-290-200).

If you wish to receive a stamped and signed “Department of Health Approved” project report from us, you need to submit an additional project report and request that the additional report be stamped, signed, and returned.

The rest of Section 2.4 outlines the minimal items that should be in all project reports. For specific project requirements, see the appropriate chapter of this manual or the applicable sections of Chapter 246-290 WAC. The level of detail in the project report should reflect the complexity of the project. We created checklists for several project types (see Appendices) that detail our expectations for project report and design submittal content.

2.4.1 Project Description

A complete and accurate project description provides us with valuable information about the project basis, orients us for an efficient design review, and serves as an important part of the overall design record. The project report **must** summarize the following general project description information (WAC 246-290-110 (4)(a)), unless a WSP describes it adequately:

1. Why you propose the project and the problem or problems it will address.
2. The recommended alternative (if applicable per Section 2.4.3), proposed construction schedule, estimated project cost, and financing method.
3. The relationship of the project to other water system components.
4. A statement of change in the physical capacity of the water system and its ability to serve customers, if applicable.
5. A copy of the environmental impact statement or determination of non-significance, or an explanation why the State Environmental Policy Act (SEPA) does not apply to the project. See SEPA Chapter 246-03 WAC. See Section 2.4.9 for information on SEPA.
6. Source development information, if applicable.
7. The type of treatment, if applicable.

2.4.2 Planning

This section discusses the relationship between planning and engineering document submittal and review. Planning is an important element in project design. If an approved WSP or SWSMP does not adequately address the following, the project report **must** address them (WAC 246-290-110 (4)(b)):

1. General project background, with population and water demand forecasts.

2. A service area map. Municipal water suppliers **must** identify their retail service area and their general service area on this map (WAC 246-290-106).
3. A description of the project's effect on neighboring water systems.
4. Local requirements, such as flow rates and duration of fire flow.
5. Additional management responsibilities, such as those in WAC 246-290-105, 415, and Chapter 246-292 WAC, Water Works Operator Certification. Also, see Section 2.4.8.
6. A project implementation and construction schedule, including project phasing, if applicable.
7. Estimated capital and operating costs, and financing method, if applicable.
8. A [Water Rights Self-Assessment Form](#), if it applies to the type of project proposed.
9. Confirmation of local government consistency (WAC 246-290-108 and [Policy B.07](#)).

2.4.3 Analysis of Alternatives

A comparison of alternative solutions helps to ensure the completed project meets the project objectives (see WAC 246-290-110(4)(c)). These objectives may include minimum life cycle costs, maximum efficiency and reliability, least lifetime maintenance, shortest implementation schedule, or some combination of these outcomes. A poor or nonexistent analysis of alternatives may result in the design failing to meet the project objectives, expensive or unreliable operations, or noncompliance with operating requirements. To the extent possible, design engineers should match engineering solutions to the problem and the capacity of the water system to properly operate and maintain the infrastructure.

2.4.4 Water Quality

Water quality should be the most important consideration in every water system design. Design engineers should consider how every design element would influence quality and public health. The project report **must** include a review of water quality as it relates to the purpose of the proposed project, including results of raw and finished water quality analyses conducted by a laboratory accredited to analyze drinking water compliance samples in Washington state (WAC 246-290-110(4)(d)). If the project involves water treatment or a filtration pilot study, see Chapter 11 and applicable sections of Chapter 246-290 WAC.

Design engineers should consider water system design holistically, so that correcting one water quality problem (e.g., replacing a source, adjusting pH, adding a chemical

disinfectant) does not lead to new or amplified water quality problems with the source or in the distribution system. Examples of such problems include:

- Installing reverse osmosis or gaseous chlorination, or adjusting pH unintentionally increasing corrosivity, leading to increased levels of lead and copper.
- Installing a new source that has a higher pH, unintentionally precipitating iron and manganese in the distribution system.
- Installing a new source with a high level of disinfectant byproduct (DBP) precursors, unintentionally forming higher levels of DBPs in the distribution system.

2.4.5 Engineering Calculations

By submitting key calculations and referring to appropriate data residing elsewhere, you support our ability to review the design efficiently. We want to ensure that the design approach complies with the design criteria (Section 2.4.6). The project report **must** include relevant technical considerations necessary to support the project, such as a physical capacity analysis, hydraulic analysis, and sizing justification (WAC 246-290-110(4)(f)). For guidance on ways to analyze the physical capacity of a water system, see Chapter 4. For guidance on hydraulic analysis, see Chapter 6.

2.4.6 Design Criteria

Identifying the design criteria allows us to understand the overall project objective, project constraints, and minimum project requirements. The project report **must** describe specific design criteria (WAC 246-290-110(g) and (h)), such as:

1. Design and construction standards, including performance standards, construction materials and methods, process control, and basis of sizing criteria, as applicable.
2. Locally adopted design standards relevant to the project, such as fire flow requirements and minimum pressure throughout the distribution system.

Consult the appropriate chapters of this manual to determine whether we require any additional engineering and design information for your project.

2.4.7 Water Rights and Other Legal Considerations

Design engineers should address legal considerations, such as land ownership and water rights, early in project design because they can affect the viability of a project. In preparing the project report, engineers **must** address water rights if the project involves a new, replacement, or modification to a source; increased withdrawal from a source; or

an increase in the water system's physical capacity or service area (WAC 246-290-110(4)(e)). Design engineers should do so by completing a [Water Rights Self-Assessment Form](#) and submitting it with the project report. We encourage design engineers and water systems to review their water right self-assessment with the Department of Ecology before submitting documents to us for approval.

Department of Ecology directs Washington's water rights permitting program. Our role is limited to ensuring design engineers include water rights information with their submittals and sharing that information with Ecology. If a water system's water rights self-assessment indicates that, when complete, a project will exceed its water right instantaneous or annual withdrawal limit, we may return the submittal and suggest the water system consult with Ecology before resubmitting.

Water rights also play a key role in adequacy determinations Ecology and local governments make. Our project-related correspondence (e.g., letter to acknowledge receipt of the submittal and our letter approving the submittal) will include a statement such as:

DOH's approval of your water system plan does not confer or guarantee any right to a specific quantity of water. The approved number of service connections is based on your representation of available water quantity. If the Washington Department of Ecology, a local planning agency, or other authority responsible for determining water rights and water system adequacy determines that you have use of less water than you represented, the number of approved connections may be reduced commensurate with the actual amount of water and your legal right to use it.

We will include such a statement in our correspondence unless, on a case-by-case basis, our engineer determines that the project has no association with water resources, water availability, or the approved number of connections. For example, installing a chemical injection treatment system to an existing source, replacing an existing water main, or re-coating the interior of a reservoir have no association with water resources, water availability, or approved connections.

Project reports **must** also identify other legal issues, such as ownership, rights-of-way, sanitary control area, and restrictive covenants (such as water-related restrictions recorded on titles or deeds). Certain projects also may require coordination with the local boundary review board or Washington Utilities and Transportation Commission (WAC 246-290-110(4)(i)). Boundary review boards exist in most Washington counties. They guide and control growth of municipalities and special purpose districts.

2.4.8 Operations and Maintenance Considerations

If the design engineer expects a project to add considerably to the water system's operational and maintenance responsibilities (such as reservoir, booster pump, source of supply, and water treatment projects), the project report **must** include the following (see WAC 246-290-110(4)):

1. Describe the routine operations tasks and frequencies.
2. Describe the preventive maintenance tasks and frequencies.
3. Identify the estimated annual operations and maintenance costs (energy, equipment, labor) and life-cycle costs. Include costs in an updated water system budget.
4. Explain whether the project triggers a requirement for a new or higher-level certified operator (Chapter 246-292 WAC) or—if creating a new water system—a satellite management agency (Chapter 246-295 WAC and [Policy B.05](#)).

2.4.9 State Environmental Policy Act Requirements

Before construction, SEPA requires certain types of projects to have an environmental impact statement, a SEPA determination of non-significance, or a document explaining why SEPA does not apply to the project (see WAC 246-03-030(3) and [Policy A.03](#)).

These requirements apply to:

- All surface water source development.
- All water system storage facilities greater than 0.5 million gallons.
- New transmission lines longer than 1,000 feet and more than 12 inches in diameter located in a new right of way.
- Major extensions to existing water distribution systems that will use pipes more than 12 inches in diameter and increase the existing service area by more than 1-square mile.

2.5 Construction Documents

Construction documents, such as detailed design drawings and specifications, **must** identify how a specific project will be constructed to satisfy the requirements and conditions established in the project report or the WSP (WAC 246-290-120). See Section 2.4 and WAC 246-290-110 for project report requirements.

If you wish to receive a stamped and signed "Department of Health Approved" set of construction documents from us, you need to submit an additional complete set of

construction documents and request that the additional set be stamped, signed, and returned.

All construction documents should conform to the established standards of the engineering profession. Approval of construction documents shall be in effect for two years from the date of our approval, unless we determine the need to withdraw approval sooner. The design engineer should contact us if construction completion exceeds the two-year approval window, to request an extension of time for the approval. We may apply additional design conditions before approving such an extension.

2.5.1 Design Drawing Requirements

Design drawings submitted for our review and approval should be legible and include:

- All the information and project specifications necessary to construct the project, including all of its components in their proper location and orientation; demonstrate compliance with applicable regulations; follow standard practices; and satisfy the project's objectives and the owner's needs.
- A location plan indicating the location of the water system.
- A service-area map showing the service-area boundary and the location of each project element.
- Name of the project.
- Name of the legal water system owner.
- Scale.
- North arrow, where applicable.
- Date.
- Name, address, and phone number of the design engineer or consultant firm.
- Revision block with the initials of the design engineer and drafter.
- The stamp and signature of the design engineer. See Washington's engineering registration requirements (WAC 246-290-040).
- Location of all applicable easements, right of ways, and property lines within the project area.
- Location of all existing aboveground and underground utilities and structures within the project impact area.
- The 100-year flood elevation within the project area, where applicable. The design **must** protect pump stations, wells, reservoirs, and treatment plants built with state revolving loan funds from a flood two feet higher than the 100-year flood elevation (WAC 246-296).

- Seismic design standards for the location where the facility will be built.

If the construction document submittal is for our review and comment, but not our approval, stamp the submission **Preliminary: For Review Only**. Be sure to communicate this to our regional staff at the time of submission. If we review and comment on preliminary documents, we will charge for the review by applying our fee regulation (WAC 246-290-990). We may review and comment on documents identified as “preliminary” but we will not approve them.

2.5.2 Project Specifications

Project specifications submitted for our review and approval should include:

- All information, complemented by the design drawings, necessary to describe the means, methods, and standards necessary to purchase, install, and test project components to satisfy the project’s objectives and owner’s needs.
- Name of the project.
- Name of the municipality, association, individual, or other entity that legally owns the water system.
- Date.
- Name, phone number, and address of the design engineer.
- The stamp and signature of the design engineer. See Washington’s engineering registration requirements in WAC 246-290-040.
- A provision for the contractor to submit shop drawings for review by owners and design engineers.
- A detailed description of all equipment and water system start-up testing, disinfection and inspection (final acceptance) procedures (required by WAC 246-290-120(4)(c)). Cut-sheets of a product or material may not substitute for technical specifications.
- A summary of the means and methods for maintaining water service throughout the construction period, if necessary.
- Certification of components in substantial contact with potable water under ANSI/NSF Standard 61 is required (WAC 246-290-220).

2.5.3 Design Changes after Project Approval

Changes to an approved design could significantly alter the means, methods, objectives, components, and even outcome of the project. Water systems **must** submit each change order that significantly alters the scope of the project, drawings, or specifications

to us for review and approval (WAC 246-290-120(4)(d)). Contact the regional office when in doubt about the need to submit design changes after approval.

Examples of changes considered “significant” and, therefore, subject to our approval:

- Change in treatment process.
- Change in type of chlorination or disinfection process used.
- Change in elevations of tank or booster stations.
- Change of materials that are in direct contact with finished water.
- Change in control systems or control strategies.
- Change in size for a storage tank.
- Change in designated pumping capacity.

Examples of insignificant change orders include minor adjustments to valve and piping locations, piping configurations, security fencing materials, and a different pump model with the same pumping characteristics. Design engineers may note changes **not** considered “significant” on the record drawings (“as-built”). For guidance on whether a particular change order is significant, contact the appropriate [regional office](#).

If we do not approve significant changes to the approved project design, the engineer cannot certify construction completion according to the approved design. See Section 2.13 for requirements to certify construction completed according to DOH-approved construction documents.

2.5.4 Contractor-Supplied Design Components

Construction documents a design engineer submits to us for our review may refer to construction drawings and specifications that the contractor needs to provide. If so, the owner **must** submit these contractor drawings and specifications to us for review and approval before construction begins (WAC 246-290-120(4)). We will apply the professional engineering requirements of WAC 246-290-040 to contractor-supplied drawings and specifications.

Examples of contractor-supplied design and construction documents that require DOH approval:

- Reservoirs
- Skid-mounted pump stations
- Packaged water treatment plants

2.6 Coordination with Local Approving Authorities

Construction projects may be subject to local permits or approvals. Compliance with our requirements does *not* guarantee compliance with local rules. Water systems **must** ensure that their projects follow local approval processes (WAC 246-290-108; WAC 246-290-120). Design engineers can usually get information on the local approval process from county building departments and environmental health programs.

2.7 Design and Review Process

Figures 2.1, 2.2, and 2.3 reflect a typical process flow-path for design and review of three general project types. Refer to general and specific project submittal checklists in Appendix A.3 for more detail.

2.8 Submittal Exceptions for Miscellaneous Components and Distribution Mains

2.8.1 Categorically Exempt

For the following types of projects, we do not require water systems to submit project reports or construction documents to us for review and approval (WAC 246-290-125(1)):

1. Installing hydrants, valves, fittings, meters, and backflow prevention assemblies.
2. Repairing a water system component or replacing it with a component of similar capacity and materials described in the original approved design. For the purposes of replacing distribution mains, *similar capacity* includes up to one standard pipe size larger.
3. Maintaining or painting surfaces not contacting potable water.

For the following components installed under the “valve” submittal exception, at a minimum the design and specifications **must** meet the following standards:

- 1. Automatic air-vacuum relief valves installed in the distribution system:** Must meet WAC 246-290-200(1)(c). See Chapter 6 for guidance on installation requirements.
- 2. Backflow prevention assemblies:** Must meet WAC 246-290-200(1)(g).

2.8.2 Exempt Distribution Main Projects

Water systems may elect not to submit project reports or construction documents for new distribution mains or larger-capacity replacement mains if they meet the following conditions (WAC 246-290-125(2)):

1. The water system has a currently approved WSP that includes standard construction specifications for distribution mains and a hydraulic capacity analysis of the basic transmission and distribution main configuration for the water system.
2. The water system maintains a completed [Construction Completion Report for Distribution Main Projects](#) (DOH 331-147) on file for each such project.

2.9 Submittal Exception: Distribution-Related Projects (not Distribution Mains)

For distribution-related projects larger and more complex than a distribution main project, you may use the more extensive Submittal Exception Process under WAC 246-290-125(3) if the design meets each condition. Eligible projects are limited to:

- Reservoirs
- Booster pump facilities
- Transmission mains
- Pipe linings
- Tank coatings

Water systems that meet the eligibility criteria (WAC 246-290-125(3)) and intend to follow the submittal exception process **must** make an initial written request to us on the [Water System Plan Submittal Form](#) (DOH 331-397). If you intend to apply for this submittal exemption, you should discuss the desired scope of exemption and planning document requirements during the preplan conference with the regional planner and engineer.

There is no submittal exception for source of supply (such as new or redeveloped wells or springs, refurbished wells, surface water intakes, interties) or water quality treatment projects (such as chlorination, corrosion control, filtration, iron, and manganese removal, UV, and ozonation).

**Figure 2.1
New Source of Supply – Project Development Flowchart**

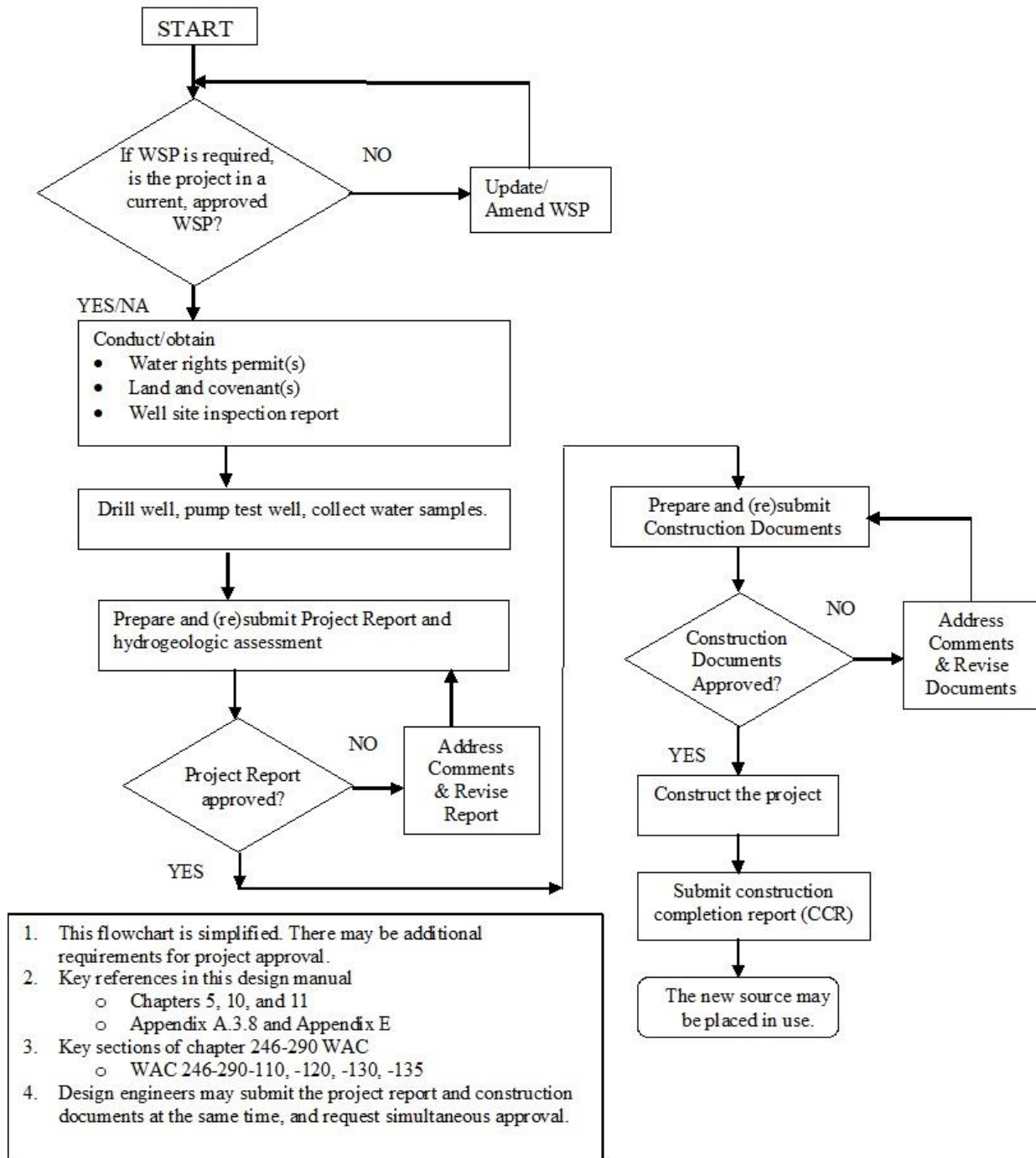
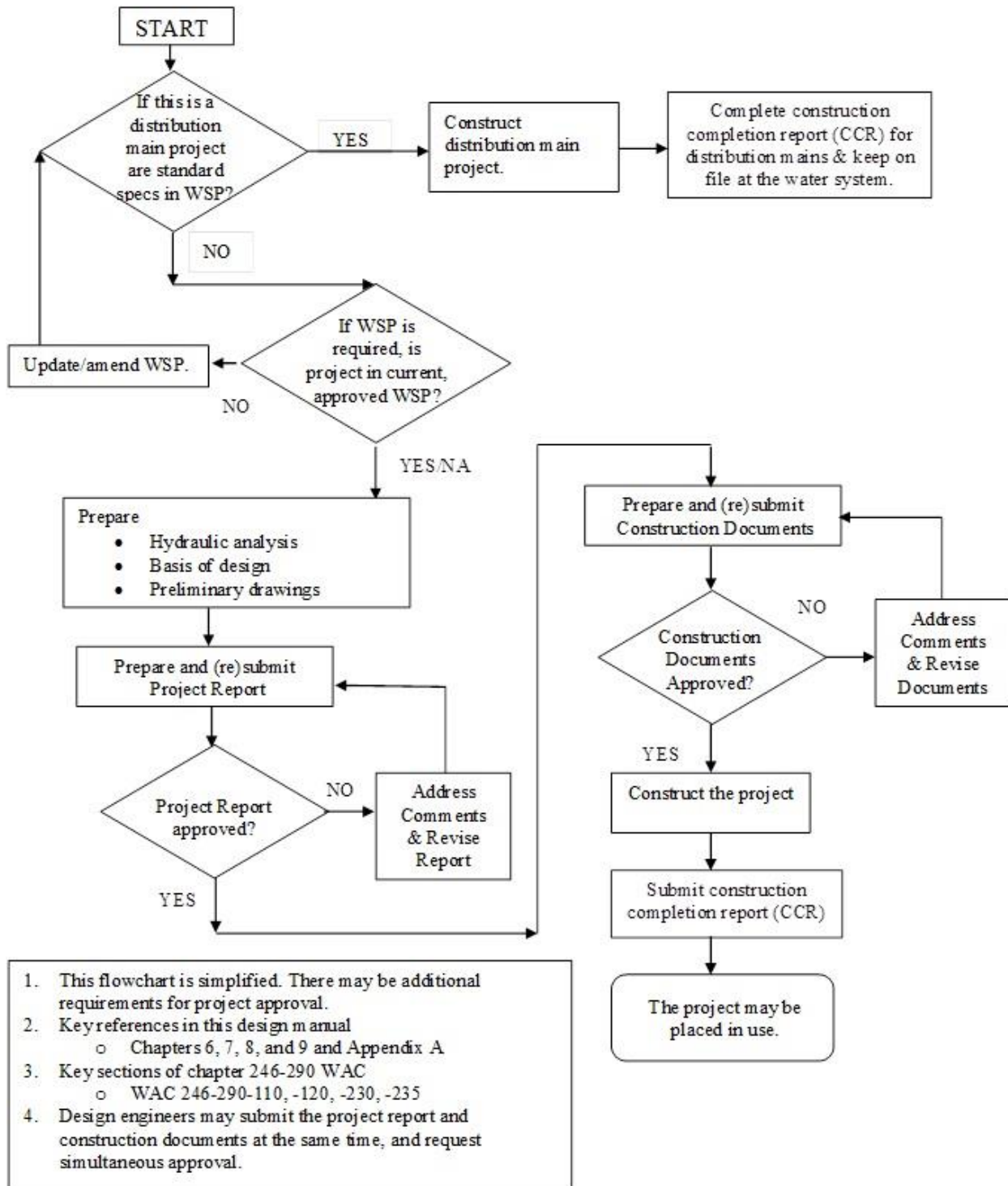
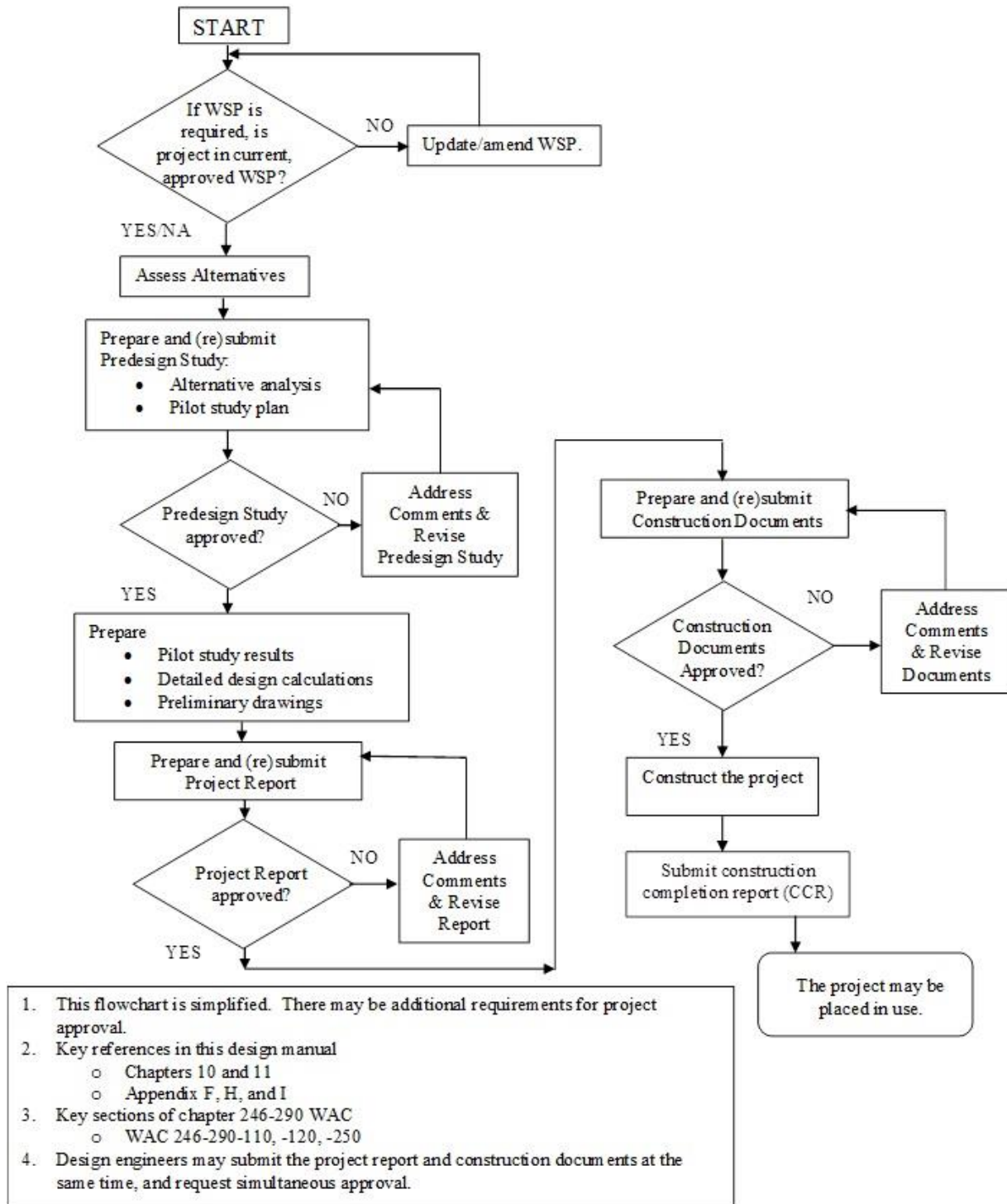

Figure 2.2
Distribution System – Project Development Flowchart



1. This flowchart is simplified. There may be additional requirements for project approval.
2. Key references in this design manual
 - o Chapters 6, 7, 8, and 9 and Appendix A
3. Key sections of chapter 246-290 WAC
 - o WAC 246-290-110, -120, -230, -235
4. Design engineers may submit the project report and construction documents at the same time, and request simultaneous approval.

Figure 2.3
Water Treatment – Project Development Flowchart



2.9.1 Design and Construction Standards for Reservoirs and Booster Pump Stations

To qualify for the submittal exception, the water system **must** include design and construction standards for distribution-related projects in an approved WSP (WAC 246-290-100(5)(b)).

The following items should be part of the WSP narrative:

1. Reservoirs:

- General location of tank sites.
- Overflow and base elevations.
- Map of service area indicating elevations of service connections.
- Basis for sizing the storage volumes needed.
- Hydraulic analysis of the water system or individual pressure zones evaluating the storage improvements.
- Level control and alarms.

2. Booster Pump Stations (BPS):

- General location of BPS site(s).
- Sizing basis for BPS capacity (flow and head) needed.
- Hydraulic analysis of the water system or pressure zones evaluating the effect of BPS operation.
- Flow, pressure, and process control.

The WSP standard specifications should include:

1. Reservoirs

- Standard tank details, including level controls, high and low level alarm, external level indicator, access hatch, vent, drain, overflow (include sizing) drain and outfall, screens, and access ladder.
- Material specifications for tank construction together with construction specifications (concrete, steel, other). ANSI/NSF Standard 61 certified materials for all surfaces in substantial contact with the water.
- Specifications for all coatings, including application, curing, and ANSI/NSF compliance. Water quality testing needed before activating tanks, such as volatile organic chemicals, if applicable (see Appendix G).
- Leakage testing and disinfection procedures per AWWA C652 (include chlorinated water disposal specifications).

- Site piping plans (generic). Also include isolation valving, type and location of sample taps, provision to improve circulation in tanks (reduce stagnation), and piping material specifications for pipes under the foundation slab, in the tank or in the yard.
- Geotechnical considerations, such as bearing strength and seismic considerations.
- Water system-specific water quality concerns affecting treatment, such as coliform testing, chlorine residuals, pH, disinfection byproducts, and contact time requirements.
- Security elements.

2. Booster Pump Stations:

- Performance specifications for booster pumps, overload capacity, and minimum shutoff heads.
- Electrical specifications, control strategies, and mechanisms.
- Pipe material, construction standards, and specifications for internal BPS piping.
- Specifications or standards for meters, control valves, and other appurtenances.
- General structural and construction specifications and standards for BPS housing.

2.9.2 Rescinding Submittal Exception Authority

We will rescind a water system's eligibility for submittal exceptions (WAC 246-290-125(2) and (3)) if the water system fails to maintain compliance with the eligibility criteria or conditions. At that point, the water system **must** submit all engineering documents (project reports and construction documents) to us for approval until it re-establishes compliance with the eligibility criteria (WAC 246-290-125).

2.10 Resolving Disputed Department of Health Review Decisions

When our review engineer and the water system or consultant cannot reconcile a difference, the water system or consultant may formally appeal our decision. We established internal processes for these circumstances. Contact the appropriate [regional office](#) for a complete description of the Brief Adjudicative Proceeding (BAP) process (see Chapter 246-10 WAC).

2.11 Review Fees and Invoice

We charge fees for reviewing project documents. These fees are set in rule (WAC 246-290-990) and may change periodically. After we complete a detailed review, we send an approval letter or review letter to the water system with an invoice for the review fee. We send a copy of the letter to the design engineer. A fee estimator worksheet is on our [water system design](#) webpage.

The rule sets most of the planning and engineering document review fees. These fixed fees cover the cost of reviewing the initial submittal and one re-submittal, if we do not approve the initial submittal the first time. If documents require more than one re-submittal, we will charge an additional fee for each subsequent review.

We assess an hourly fee for some of the fee-for-service activities listed in WAC 246-290-990. We will charge the rate indicated in the rule for each hour spent on the hourly fee-for-service activity. To minimize the cost and review time, design engineers should ensure each submittal is as complete and accurate as possible. Use the *Project Submittal Checklists* in the Appendices.

2.12 Project Approval Letter and Construction Completion

When construction documents meet all requirements, we will send an approval letter to the system owner, with copies to the design engineer and others, as appropriate. A typical construction-document approval includes the following enclosures:

- An invoice for the review fee, if we did not already send it.
- A *Water Facilities Inventory Form*, if project completion will change any information on the form. We will ask the water system to update and return the inventory form after completing the project.
- A [Construction Completion Report Form](#) (DOH 331-121).

2.13 Construction Completion Report Forms

There are three types of *Construction Completion Report Form*. Each form is used in different circumstances, so it's important to know the difference.

1. [Construction Completion Report Form \(DOH 331-121\)](#). Use this form in the normal process of submitting documentation for a project that underwent our design review and approval; it certifies construction according to the DOH-approved

design. This form applies to WAC 246-290-120(5). We will send it with the construction approval document referenced in Section 2.12.

2. [Construction Completion Report Form for Distribution Main Projects \(DOH 331-147\)](#). Use this form only for distribution main projects not requiring prior written approval from us. The water system does not have to submit this form to us following construction completion. However, the water system **must** maintain a completed form on file and make it available to us upon request. This form applies to the submittal exception process (see Section 2.8 and WAC 246-290-125(2)).
3. [Construction Completion Report Form for Submittal Exception Process \(DOH 331-146\)](#). Use this form only for distribution-related projects not requiring prior written approval from us. Distribution-related projects include booster pump stations, reservoirs, internal tank coatings, and transmission mains. The water system **must** submit this report to us after constructing a new reservoir or booster pump station, but only maintain a completed form on file for other distribution-related projects (WAC 246-290-125(3)(f)). This form applies to the submittal exception process (see Section 2.9 and WAC 246-290-125(3)).

If the completed project changes any information on the *Water Facilities Inventory* (WFI), the water system is responsible for submitting an updated WFI with the signed *Construction Completion Report*.

2.14 Record Drawings

The engineer who manages construction or inspection typically provides record drawings to the water system when the project is complete. The water system **must** maintain a complete set of record drawings and provide them to DOH on request (WAC 246-290-120(4)(e)).

2.15 Safety

Improperly designed facilities could put employees, contractors, and the public at risk. If someone gets hurt, the water system could face a lawsuit or citations and penalties from the Washington State Department of Labor and Industries (L&I). Design engineers should be aware of the full scope of state and federal regulation governing safe working environments (Washington Industrial Safety and Health Act, 49.17 RCW; Occupational Safety and Health Act).

For detailed safety information, contact L&I or visit www.lni.wa.gov/safety/default.asp.
The website has information on:

- Asbestos
- Confined spaces
- Excavation and trenching
- Fall protection
- Guardrails
- Ladders
- Lead
- Lockout/Tagout

Contact information for L&I and Occupational Safety and Health Administration (OSHA) is in Appendix C.

Chapter 3: Estimating Water Demands

3.0 Applicability

Design engineers use water demand estimates to design new water systems or additions to existing water systems. To size any water system or its component parts, an engineer **must** estimate water system demand and consumers' consumption (WAC 246-290-221). This chapter provides basic, conservative water-demand design criteria engineers may use if they lack information that is more appropriate.

Design engineers using historical water use records to design future water system facilities should attempt to validate the information. Given the many variables that affect consumer demand (see Section 3.2), design criteria based on historical data should include a reasonable margin of safety. The more detailed the historical demand records are, the longer the period that data covers, and the greater the designer's confidence in the validity of that data, the smaller the margin of safety needs to be. This basic concept applies to every recommendation in this chapter.

This chapter has three parts:

1. **Residential Demand Estimates:** Focuses on water systems where residential demands comprise a significant portion or all of the demand.
2. **Nonresidential Demand Estimates:** Focuses on water systems where residential demands comprise an insignificant portion of total demand.
3. **General Considerations:** Covers issues that apply to both residential and nonresidential demand estimates.

3.1 Demand versus Consumption

It is important for design engineers to differentiate between the productive requirements of a water system and total consumptive demand. The difference in these two values includes the volumetric loss through distribution system leakage (DSL). The rule defines DSL percentage (WAC 246-290-820(2)) and the industry uses Equation 3-3 to determine DSL volume. For some existing water systems, DSL may be substantial enough that ignoring its contribution to productive requirements would create a meaningful deficit in design. Such a deficit might constrain the ability to operate within approved design parameters. When designing new water systems, we expect design engineers to consider the future state of the distribution system, and make an appropriate allowance for DSL.

Part 1: Residential Demand Estimates

3.2 Consumer Demand

An equivalent residential unit (ERU) is central to the evaluation and design of water systems with significant residential demand. An ERU is *a system-specific unit of measure used to express the amount of water consumed by a typical full-time single-family residence* (WAC 246-290-010). This value is particular to the existing water system that derived it. In this manual, we refer to an ERU value reflecting various demand scenarios.

- **ERU_{MDD}** is the amount of water a typical full-time single-family residence consumes during high demand. It approximates the maximum daily demand of a typical full-time single-family home. It is the ERU value used in a physical capacity assessment (see Chapter 4).
- **ERU_{ADD}** value approximates the average daily demand of a typical full-time single-family residence. The ERU_{ADD} value may be used in assessing factors bounded annually, such as a water supply safe annual yield and a water right annual volume (Qa).

For most water systems, consumer consumption accounts for a significant majority of water that the system's supply must produce. In order of preference, the information sources for estimating consumer's consumption are:

1. Actual metered records, if the design engineer considers that data complete and accurate (see WAC 246-290-221(1)).
 - a. Information on water production should be available from every existing Group A public water system. The requirements to install and maintain source meters and to read source meters at least once per month (WAC 246-290-100, -105, and -496, and WAC 173-173-060) have been in place for many years.
 - b. Most community water systems have service meters. As of January 2017, all community water suppliers with 15 or more connections **must** install service meters, and **must** calculate and report distribution system leakage (WAC 246-290-820). We consider this primary consumptive data for an individual water system most applicable for projecting future consumer consumptive use if the data is complete and accurate, and the design engineer takes into account full-time and part-time consumers when evaluating this data.
2. Comparable metered data from an *analogous* water system, if the system serves all or almost all full-time residential customers. For elements we consider important when considering consumptive data from an existing system in the design of a new one, see WAC 246-290-221(3)(a) and Section 3.2.3.
3. The consumer demand criteria presented in this chapter and in Appendix D.

The design engineer should assess the degree of confidence in the validity of available data. The smaller the degree of confidence, the larger the design's margin of safety needs to be.

3.2.1 Evaluating Actual Water Demand

The analysis of historical water demand should include these considerations:

- 1. Use actual water demand information.** Base additional services on actual water demands. Water systems cannot justify new services solely by committing to implement a water-use efficiency program. See Section 3.8.
- 2. Use multiple years of data.** Base the historical water production and consumption analysis on meter readings covering at least two, but preferably more years. The meter readings should include daily production metered data for the peak usage period and weekly or monthly usage during the rest of the year. Most community water systems experience peak demand from June through September. Other water systems, such as ski resorts, may experience peak demand during the winter.
For most water systems, the historical water use analysis **must** quantify distribution system leakage and total authorized consumption (WAC 246-290-820). See Section 3.8 for information on distribution system leakage and authorized consumption. Keep in mind system-wide ADD and MDD production data include consumption plus distribution system leakage as defined in WAC 246-290-820.
- 3. Correlate data with occupancy.** Water demand data **must** be correlated with the number of full- and part-time residential service connections actually in use when the data was collected (WAC 246-290-221(1)). To quantify residential demands more clearly, the analysis should separate industrial, commercial, or other water demands from residential demands.
- 4. Anticipate changes that might increase demand.** The analysis should address potential changes in demand (see Section 3.5).
- 5. Normalize data based on climatic conditions.** Review rainfall and temperature data to verify their effect on water system demand. Rainfall and cool weather usually decrease water demand; and hot, dry weather usually increases water demand (unless a system imposes drought restrictions). Appendix C includes climatological organizations (NOAA, Office of the State Climatologist, and Western Regional Climate Center) with data that may assist with determining how current-year precipitation compares with historic weather patterns.

Design engineers should compare water demand data to historical climate information to determine if it is necessary to adjust historical demand data up or down. Summer temperature and precipitation data from the Office of the

Washington State Climatologist will tell whether the data period was an unusually wet/cool summer, average, or what was considered a hot/dry summer. Visit <http://www.wrcc.dri.edu/summary/Climsmwa.html>, and use the statewide map to get precipitation and temperature data for the nearest gauging station.

- a. Water production and consumption data over wet/cool summer(s). In such cases, it would be appropriate to look at an expanded period of metered-use data, or adjust the calculated ERU_{ADD} and ERU_{MDD} values higher, to account for the hotter, drier summers that will inevitably follow.
- b. Water production and consumption data over hot/dry summer(s). In such cases, it would be inappropriate to dismiss the data as “worst case” unless the rainfall and temperature represented conditions approaching a two-standard deviation difference from the mean as measured over many years. A hot, dry summer that isn’t a statistical anomaly is considered a normal operating condition. In addition, under this condition, engineers **must** design water system facilities to meet performance standards in WAC 246-290 Part 3.

3.2.2 Full-Time and Part-Time Single-Family Residential Users

We prefer that design engineers estimate ERU_{MDD} based on consumptive use. If consumptive use data is unavailable or considered invalid, then design engineers can use source meter data to estimate ERU_{MDD} if all customers are single-family residential, all residences are occupied full time, and the design engineer acknowledges that the ERU_{MDD} value includes consumption and DSL. When customers occupy homes intermittently, dividing total production by the total number of homes may significantly underestimate future demand, as part-time customers become full-time customers.

Water demand design data **must** correlate to the number of full-time or part-time equivalent residential units in service at any time (WAC 246-290-221(1)). “Full-time” is a permanent place of residence. “Part-time” is a vacation home, used only seasonally, such as on holidays or weekends. The rule makes this distinction because water systems designed only for part-time residences may convert gradually over time to full-time residences (due to retirement, changing housing markets, and other factors).

We will not approve a water system for part-time residential use unless obligatory covenants or other binding agreements prohibit full-time occupancy. Water systems designed only for part-time residences cannot expect to provide service levels adequate for full-time occupancy. Future demand assigned to each proposed residential dwelling unit **must** reflect full-time occupancy (WAC 246-290-221 (2)). Give the same consideration to each existing part-time residence. This concept reduces concerns associated with part-time residents changing to “full-time” without sufficient water

supply and delivery facilities. This concept also applies to part-time versus full-time multifamily residences.

Obtaining source meter records over any selected period is relatively straightforward. However, determining occupancy levels during that same period can be quite difficult. Water systems can use the following approaches to correlate source meter data with estimated occupancy levels. Each of these approaches has shortcomings, so we recommend using more than one to achieve an appropriate safety factor based on the degree of uncertainty.

- **Survey customers.** Very small water systems with about 50 or fewer connections may be able to use a survey to estimate daily or weekly occupancy for a short period of time when they can rigorously take meter readings. If the primary capacity limitation is associated with MDD, the survey could focus on the expected peak-demand period of summer.
- **Service meter records.** Many water systems have service meters, and all municipal water suppliers **must** install meters on their direct service connections (WAC 246-290-496(2)). Water systems usually read service meters monthly, bimonthly, or quarterly. The frequency of meter reading limits the outcome of this method. In one comprehensive study, median indoor residential water use ranged from 54 to 64 gallons per capita per day for several communities throughout the United States (Mayer et al. 1999). When water use for a residence falls significantly below this range, residents probably occupy the dwelling intermittently. Reviewing service meter records may help you select the time to use an intensive meter-reading program to correlate demand with occupancy.
- **Assume full occupancy on holidays.** For some small recreational water systems, it may be reasonable to assume full occupancy during certain times of the year, such as Memorial Day or Labor Day weekends. Other water systems may be able to assume full occupancy on other days. Meter readings on those days, especially if the water system assumes high demands will occur, could help to estimate peak day demand. You should supplement this approach with a customer survey on these target weekends.
- **Demand patterns.** Demands that vary significantly between billing periods could indicate an intermittently occupied residence.
- **Tax, voting, and other public records.** These may help to determine occupancy levels. However, there are several shortcomings to using public records to estimate occupancy. For example, people who live part-time in Washington and part-time in a warmer climate appear as full-time residents on assessor and voting records. Rental properties are another example. Similar to vacation homes, the assessor sends tax

records for rental properties to owners at their primary residences. Renters may not register to vote where they reside.

When using service meter records to establish the ERU_{MDD} value, be sure to account for any part-time uses that occurred during the record-keeping period (such as the maximum month). You should use only residences occupied full time during the time of metered data collection. Be sure to confirm the correlation between meter information and the various types of service (residential versus nonresidential) when determining the ERU_{MDD} value for the water system.

3.2.3 Analogous Water Systems

Lacking metered water-use records, engineers may use comparable water use data from an analogous water system (WAC 246-290-221(3)) to design a new water system. Because existing water systems **must** have and read source meters (WAC 246-290-221), there is generally no need to look elsewhere for appropriate production or demand information. We consider analogous system information, when available, the best information to use when designing a new water system.

To be analogous, water systems **must** have similar characteristics (WAC 246-290-221(3)(a)). Characteristics include:

- 1. Population and development pattern.** Demographics are the vital statistics of human populations such as size, growth, density, and distribution. Demographics change with the nature of the development. Population densities differ from single-family to multifamily residences, from housing provided for families to housing provided for single occupancy, and from individual lots to mobile home park developments.
- 2. Lot size.** A major factor in water use related to larger lot sizes is in the irrigated area (lawns, gardens, and agricultural uses). However, it is possible to Xeriscape (use native flora, rockery, and pavement) multi-acre tracts with very little need for supplemental irrigation.
- 3. Climactic zone.** Climate significantly effects water use. High temperatures and low precipitation usually lead to an increase in water use. To be analogous, water systems should have similar monthly and average annual temperature and precipitation. In areas where freezing temperatures are prevalent in winter, high demands may occur if users allow faucets to run to prevent freezing. You can also expect water demand to increase during the winter for water systems serving winter use activities, such as a ski resort.
- 4. Cost of water service.** Water pricing structure relates to the use of “inclining block rates” versus “declining block rates.” Both require using individual meters. For “flat

rates,” meters are often absent and analogous water demands are more difficult to predict. To be analogous, the existing and proposed water systems should provide the same level of metering and have similar rate structures.

- 5. Water conservation standards.** The analogous water system’s conservation practices should be the same as the proposed water system. These practices include, but are not limited to, alternate day watering schedules, installing low-water-use fixtures, toilet-tank displacement devices, leak detection, and water demand reduction programs. Water use restrictions should mirror voluntary or mandatory curtailment measures requested of analogous water system consumers. These may be in community covenants, bylaws, local ordinances, or on property deeds. It is very important to determine whether the restrictions are enforceable. A legal opinion may be necessary to determine equivalent enforceability.
- 6. Soil type and community landscape standards.** Soil types and landscaping can affect irrigation demands. Moisture retention and evaporation losses from sands and gravels differ from loams, silts, and clays. When designing a water system, engineers should check with the local Cooperative Extension office to determine and evaluate variables that may affect water demand. For example, water demands for landscaping vary largely between natural flora and more water-dependent plants.
- 7. Maintenance practices.** Engineers should consider the analogous water system’s maintenance practices. These practices include the seasonality, frequency of, and volume of water used for line flushing, exercising hydrants and valves, and cleaning tanks.

There are more reasons for water-use patterns to vary between water systems. Sociological factors play a role. It is nearly impossible for a design engineer to predict the mind-set or water use ethic of consumers on a new water system. When basing a water system design on characteristics analogous to another water system, we recommend conservative water demand estimates. A safety factor is appropriate even if the proposed water system has the same enforceable water use efficiency practices and use restrictions as the identified analogous water system. It may be wise to discuss this design approach with the regional engineer early in the design phase of a project.

3.2.4 DOH Default Water Demand Design Criteria (Appendix D)

Residential demand is the largest portion of total demand for most water systems. The design engineer with adequate historical service or source meter records can usually estimate residential demands with reasonable accuracy. It is also important for engineers to estimate nonresidential demands related to industrial, commercial, and similar types of uses.

For new water systems or existing systems with inaccurate or insufficient records, and without analogous system information to draw from, the design engineer may use the information in Appendix D to estimate ERU_{ADD} and ERU_{MDD} for residential connections (WAC 246-290-221(3)). Limitations on using water demand estimating criteria in Appendix D:

- ERU_{ADD} reflects consumptive use data (it does not include DSL), and therefore ERU_{MDD} generated under Appendix D excludes DSL.
- The information in Appendix D does not specifically address commercial and industrial demands. Design engineers should use information in Table 3-2 for nonresidential consumer demand.
- Appendix D data does not adequately represent large-lot irrigation demands. Engineers designing new water systems that intend to serve residents who will use the public water system to irrigate lots greater than ½ acre should undertake a detailed estimate of ERU_{MDD}. We recommend applying a value of 350 gallons per day to address in-house domestic demand (see Section 3.4.1) plus a detailed assessment of irrigation demand based on estimated irrigation demands in Table 3-2 or other published reference specific to the area, climate, and soil type.

3.3 Water System Demand

Maximum daily demand (MDD) is *the highest actual or estimated quantity of water that is, or is expected to be, used over a twenty-four hour period, excluding unusual events or emergencies* (WAC 246-290-010 defines).

For the purposes of this manual, we take a broad view of MDD as it applies to the term “used.” We consider MDD to be the system-wide peak daily production requirement necessary to meet the consumptive demands of all types of connections; other intentional uses not associated with a connection; and the quantity of water lost through leakage or illicit uses. When we refer to MDD in this manual, we mean the maximum daily source production/treatment required within a 24-hour period to meet all these withdrawals from the distribution system. Fire suppression is not a component of MDD. Engineers **must** design water system source and treatment so that together they can satisfy the maximum daily demand (WAC 246-290-222).

Average daily demand (ADD) is *the total quantity of water used from all sources of supply as measured or estimated over a calendar year divided by 365* (WAC 246-290-010).

We take a broad view of ADD as it applies to the term “used.” We consider ADD to be the system-wide average daily production requirement needed to meet the consumptive demands of all types of connections; other intentional uses not associated with a connection; and the water lost through leakage or illicit uses. When we use the term “ADD” in this manual we mean the source production/treatment required to meet all these withdrawals from the distribution system during an entire year divided by 365.

Design engineers using advanced analysis of complex demand scenarios may need to analyze the component elements of MDD or ADD separately. For example, identifying demand by customer class (such as $MDD_{\text{residential}}$, $MDD_{\text{commercial}}$).

3.4 Estimating Water System Demands

Engineers need to establish water demand estimates, with an appropriate factor of safety, to assess the adequacy of the water system’s source and treatment capacity; to assess the adequacy of the water system’s water rights; and to size pumping equipment, transmission lines, distribution mains, and water storage facilities properly.

Water systems **must** read source meters at least monthly (WAC 246-290-100(4)(b), 105(4)(h), and WAC 173-173-060). Design engineers **must** use metered production records to quantify MDD and ADD for most water systems (WAC 246-290-221). For new water systems without metered data, design engineers can use analogous water system data or the information in Appendix D to estimate the ERU_{MDD} and ERU_{ADD} .

Design engineers **must** assess the adequacy of the water system’s water right, especially the attributes of annual volume (Q_a) and instantaneous withdrawal (Q_i) (WAC 246-290-110(4)). Q_a is associated with ADD, and Q_i is associated with MDD. See examples in Section 3.12.

3.4.1 Maximum Day Demand

Ideally, the water system can provide the design engineer with daily production records from each source of supply. A design engineer who can only rely on monthly source meter records will need a peaking factor to estimate the system-wide MDD from the maximum month’s average day demand (MMADD).

Based on our analysis of 79 water systems in Washington, we recommend the following MDD to MMADD ratio:

- 1.65 for systems serving fewer than 1,000 people
- 1.35 for systems serving 1,000 to 100,000 people

We recommend using an MDD to MMADD ratio between 1.35 and 1.65 for water systems near the 1,000-person threshold. Appendix D.3 describes the results of this analysis in more detail. For new water residential-only systems without metered data, design engineers can use analogous water system data or the information in Appendix D.1 to estimate the ERU_{MDD} .

In general, the lower limit for ERU_{MDD} is 350 gallons/day/residential connection (WAC 246-290-221(4)). This demand estimate is consistent with the Department of Ecology on household water uses for developments that prohibit irrigation. There may be some projects with sufficient verified information (meter records, at least two years of data) to support an ERU_{MDD} value of less than 350 gallons per day. The data may only be used in support of expansion for that specific water system (WAC 246-290-221(4)).

Multifamily residences typically use less water per dwelling than separate single-family residences. Water uses for multifamily residences vary from water system to water system. They are usually specific to a given water system, but not always applicable to another water system. Engineers should view multifamily-metered consumption data apart from single-family data when calculating ERU_{MDD} . Divide the total peak-day water use for the multifamily connection(s) by the water system-specific ERU_{MDD} to determine the number of ERUs multifamily connections contribute.

In a few isolated cases in Western Washington, the ERU_{MDD} has been as high as 2,000 gpd per connection. In Eastern Washington, the ERU_{MDD} for some water systems has been as high as 8,000 gpd per connection. Design engineers should recognize that some water systems are outside the norm and will have much greater water demand, and that our assumptions about $ERU_{MDD} = 2 \times ERU_{ADD}$ may result in a significant shortfall in supply during built-out peak day demand.

3.4.2 Peak Hourly Demand (PHD)

Engineers need PHD estimates to size equalizing storage, distribution mains, and some pumping facilities. They **must** design a water system to provide PHD while maintaining a minimum pressure of 30 psi throughout the distribution system (WAC 246-290-230(5)). Engineers can develop and use water system-specific diurnal demand curves to estimate PHD (AWWA 2012). Engineers usually need multiple diurnal demand curves because demand changes seasonally (AWWA 2012).

Design engineers may use Equation 3-1 to determine PHD for systems with predominantly residential demands. This equation is consistent with the maximum instantaneous demand values presented in previous editions of the state's design

guidance manuals (WSDSHS 1973; WSDSHS 1983) known as the “Red Book” and “Blue Book,” respectively. Equation 3-1 accounts for the ranges of PHD to MDD ratios reported as a function of water system size and by various water systems in Washington.

Key concepts associated with the use of Equation 3-1:

- Applies to water systems with significant residential demand.
- N is the number of ERUs supplied by all sources. DSL has an associated number of ERUs (see examples in Section 3.12 and Worksheet 4-1). Therefore, N includes DSL. “N” is the number of connections only if there is no distribution system leakage and all connections are single-family homes.
- Check to be sure that ERU_{MDD} times “N” equals total maximum daily source production.
- The ERU value is ERU_{MDD}. It is not appropriate to apply the ERU_{ADD} value to Equation 3-1.

Equation 3-1: Determine PHD

$$PHD = (ERU_{MDD} / 1440) [(C)(N) + F] + 18$$

- Where**
- PHD** = Peak Hourly Demand, total system (gallons per minute)
 - C** = Coefficient Associated with Ranges of ERUs
 - N** = Number of ERUs based on MDD
 - F** = Factor Associated with Ranges of ERUs
 - ERU_{MDD}** = Maximum Day Demand per ERU (gallons per day)

Table 3-1 identifies the appropriate coefficients and factors to substitute into Equation 3-1 for the ranges of single-family residential connections:

Table 3-1

Number of ERUs (N)	C	F
15 – 50	3.0	0
51 – 100	2.5	25
101 – 250	2.0	75
251 – 500	1.8	125
> 500	1.6	225

PHD relates to the hydraulic ability of a distribution system to accommodate a range of ERUs. A PHD evaluation determines the physical capacity of the whole water system, not each specific ERU. Engineers can use this equation to estimate the peak-hourly flow for

the whole water system, or a specific pressure zone, after determining the number of ERUs.

3.5 Anticipating Changes in Demand: Systems with Mostly Residential Demand

Water demand estimates should address anticipated changes as a water system matures. An analysis should address how future water-use patterns may change. For example, vacation lots may become retirement homes, or be sold as permanent residences in a phased plan for development.

The analysis should consider commercial activities associated with full build-out of the development or community. Base MDD and PHD estimates for water systems serving general commercial and business needs on the appropriate application of analogous system data, Table 3-2, and the UPC fixture method (see Appendix D.2).

Adjustments to any established design criteria should reflect actual or anticipated conditions. These adjustments should provide a realistic margin of safety for reasonably anticipated increases in demand. For some projects, future water system demand, or standby or fire suppression storage needs may exceed the engineer's initial estimate. This could occur when a water system experiences higher-than-expected growth, changing uses among existing customers, has historical supply reliability problems, or experiences higher or lower service demand due to changing economic and demographic influences.

3.5.1 Referencing Data from Prior Years

Using meter data from several prior years will result in calculating different ERU_{ADD} and ERU_{MDD} from one year to the next. If the data is scattered, without any clear trend, then apply the highest ERU_{ADD} and ERU_{MDD} value within the study period to the design unless one of the following:

- The design engineer can show that the data is unreliable or incomplete.
- The highest ERU_{ADD} and ERU_{MDD} value is based on an unrepeatably event, such as a chronic failure of the reservoir level control, widespread installation of new landscaping requiring especially heavy irrigation, or use of the water supply to assist with dust control during an unusually active construction season.

Good water system design provides water systems with the capacity to supply the volume of safe drinking water their customers demand during all normal operating conditions. Applying an average of past normal operating conditions to future

customers by definition excludes some normal operating conditions. Generally, engineers should not average water demand data spanning a period of several years to determine ERU_{ADD} and ERU_{MDD} for the built-out or planning year condition.

If production or consumption data reflect a clear trend toward higher or lower ERU_{ADD} and ERU_{MDD} with time, factor such trends into determining the selected design ERU_{ADD} and ERU_{MDD} value *while not extrapolating below the lower limit of the data set*.

In evaluating data, design engineers should exercise caution when water production data spans a period of imposed water use restrictions. A water system's decision to impose water use restrictions in response to drought conditions can artificially skew demand data lower. The National Drought Mitigation Center has historical drought information. Contact information is in Appendix C.

3.5.2 Commercial, Industrial, and Public Facilities

Engineers can base MDD and PHD estimates for industrial water systems on customer contracted volumes (gpd or gpm), defined process needs, and/or analogous system data. Existing industrial and commercial users may have data logging capacity on their service meters, providing the design engineer with primary data on MDD and PHD that would be useful in designing for expansion of the system.

The analysis should address how future water-use may evolve without any change in the number of structures or spaces. For example, a concert venue may become more popular than anticipated, a second shift may be added to a place of work, the irrigation or recreational water demands on the system may increase as the clientele of a facility change, or a change in facility use may change water demand (e.g., a warehouse becomes a brewery and restaurant).

Part 2: Nonresidential Demand Estimates

3.6 Estimating Nonresidential Water System Demand

Nonresidential water demand is the water users other than single or multifamily residential units consume. These users include:

- Commercial facilities like retail or wholesale businesses, restaurants, hotels, office buildings, and car washes.
- Industrial customers that require process water.
- Public facilities like schools, public hospitals, governmental offices, parks, landscaped roads, and cemeteries.
- Other large users, like farms with irrigated crops.
- Recreational users like campgrounds, RV parks, ski resorts, and seasonal rental units.

We classify water systems that consist solely of these types of users as “transient noncommunity” or “nontransient noncommunity” water systems (see WAC 246-290-020). The ERU model does not apply to these types of water systems.

Design engineers should use different approaches to determine water demands for nonresidential customers because these types of customers do not follow residential water use patterns. Applying the principles of Section 3.2, use the following sources of information to estimate ADD, MDD, and PHD for nonresidential uses:

- Actual water use information correlated to the expected future uses (for an expanding nonresidential system)
- Values from an analogous nonresidential water system
- Values from Table 3-2
- Fixture unit analysis based on Uniform Plumbing Code guidelines (see Appendix D.2 for guidance)

In evaluating data, design engineers should exercise caution when water production data spans a period of imposed water use restrictions. A water system owner’s decision to impose water use restrictions in response to drought conditions can artificially skew demand data lower. Using artificially low production and demand data to design an expansion to the system would permanently lock in constrained water use conditions.

3.6.1 Procedures for Estimating Nonresidential Demands

Design engineers can base ADD and MDD estimates for **new** nonresidential water systems on similarly sized analogous facilities or water systems. Table 3-2 offers reasonable estimates of daily water demands for a variety of uses. Design engineers can create a reasonable estimate for MDD by multiplying the number of “units” (e.g., resident, RV, bed, patron, etc.) or maximum anticipated use (e.g., airport passengers, vehicle visits) the water system serves times the unit water demand value in Table 3-2. Table 3-2 does not account for outdoor watering needs and fire protection requirements associated with uses listed.

Design engineers may find other information sources more valuable than Table 3-2. The designer should review several information sources to ensure compliance with local codes and to provide for an adequate factor of safety in the design. Recommended resources include the:

- **Uniform Plumbing Code (UPC).** Under Appendix A of the UPC, engineers can total the number of water supply fixtures in a building and convert it to an estimated peak water system demand. Local jurisdictions may require a water system to use the UPC to estimate demand.
- **Department of Ecology.** Engineers should consult any specific water-demand estimates Ecology prepared to see if they reflect adjustments for the proposed water-use efficiency practices.
- **American Water Works Association (AWWA).** Design engineers should consult AWWA for information on recently developed or updated demand estimates. If the design engineer cannot find pertinent information through other sources, refer to AWWA guidelines in Table 3-2 and the UPC.
- **National Forest Service.** FSH 7409.11 - *Sanitary Engineering and Public Health Handbook*, Chapter 40 – Drinking Water System Design and Construction, last revised October 1, 2004.
- **DOH Regional Office.** If information in Table 3-2 does not appear to apply to the project, design engineers can contact us to determine appropriate criteria that may apply on a case-by-case basis.

Table 3-2: Guide for Maximum Daily Nonresidential Water Demand¹

Type of Establishment	Water Used (gpd)
Airport (per passenger)	3 - 5
Bathhouse (per bather)	10
Boardinghouse (per boarder)	50
Additional kitchen requirements for nonresident boarders	10
Camp	
Construction, semi-permanent (per worker)	50
Day, no meals served (per camper)	15
Luxury (per camper)	100 - 150
Resort, day and night, limited plumbing (per camper)	50
Tourist, central bath and toilet facilities (per person)	35 ²
Cottage, seasonal occupancy (per resident)	50
Club	
Country (per resident member)	100
Country (per nonresident member present)	25
Factory (gallons per person per shift)	15 - 35
Highway rest area (per person)	5
Hotel (per person)	50
Institution other than hospital (per person)	75 - 125
Hospital (per bed)	250 - 400
Lawn and Garden (per 1,000 sq. ft., applied at 2-inches per week)	180 gpd per 1000 sf ³
Laundry , self-serviced (gallons per washing per customer)	50
Livestock Drinking (per animal)	
Beef, yearlings	20
Brood Sows, nursing	6
Cattle or Steers	12
Dairy	20
Dry Cows or Heifers	15
Goat or Sheep	2
Hogs/Swine	4
Horse or Mules	12
Livestock Facilities	
Dairy Sanitation (milk room)	500
Floor Flushing (per 100 sq. ft.)	10
Sanitary Hog Wallow	100
Motel	
Bath, toilet, and kitchen facilities (per bed space)	50
Bed and toilet (per bed space)	40
Park	
Overnight, flush toilets (per camper)	25 ²
Trailer/RV no sewer connection (per trailer)	25 ²
Trailer/RV connected to sewer (per trailer)	140 ⁴
Picnic	
Bathhouses, showers, and flush toilets (per picnicker)	20

Type of Establishment	Water Used (gpd)
Toilet facilities only (gallons per picnicker)	10
Poultry (per 100 birds)	
Chicken	5 - 10
Ducks	22
Turkeys	10 - 25
Restaurant	
Toilet facilities (per patron)	7 - 10
No toilet facilities (per patron)	2 ½ - 3
Bar and cocktail lounge (additional quantity per patron)	2
School	
Boarding (per pupil)	75 - 100
Day, cafeteria, gymnasiums, and showers (per pupil)	25
Day, cafeteria, no gymnasiums or showers (per pupil)	20
Day, no cafeteria, gymnasiums or showers (per pupil)	15
Service station (per vehicle)	10
Store (per toilet room)	400
Swimming pool (per swimmer)	
Maintenance (per 100 sq. ft.)	10
Theater	
Drive-in (per car space)	5
Movie (per auditorium seat)	5
Worker	
Construction (per person per shift)	50
Day (school or offices per person per shift)	15
Footnotes	
¹ Table adapted from <i>Design and Construction of Small Water Systems</i> (AWWA, 1984) and <i>Planning for an Individual Water System</i> (Assn for Vocational Instructional Materials, 1982), unless otherwise noted.	
² Add the 25-35 gpd per camper value to the 25 gpd where trailer/RV is without a sewer connection.	
³ U.S. Bureau of Reclamation, Argimet, 2015, for Eastern Washington locations.	
⁴ WSDSHS. 1983. <i>Sizing Guidelines for Public Water Supplies</i> , Washington State Department of Social and Health Services, Olympia, WA.	

3.6.2 Commercial, Industrial and Public Facility Demand

Water demands for commercial, industrial, and public facility categories range widely from less than, to significantly more than, a single-family residence. This is especially true for large farm irrigation needs or commercial and industrial processes.

Engineers can base MDD and PHD estimates for industrial water systems on customer contracted volumes (gpd or gpm), defined process needs, and/or analogous system data. Existing industrial and commercial users may have data logging capacity on their service meters, providing the design engineer with primary data on MDD and PHD that would be useful in designing for expansion of the system. If data is available and verified as accurate, it may be possible to develop a diurnal curve for each existing large nonresidential customer. This curve could help quantify PHD and identify when PHD

occurs in relation to other large and small users. Using this approach, design engineers could estimate a system-wide PHD based on a summation of individual large user PHD plus various other class-wide PHD, taking into account the time of day when each peak demand occurs.

Design engineers can estimate MDD and PHD for water systems serving general commercial and business needs by appropriately applying analogous system data, Table 3-2, the UPC fixture method (see Appendix D.2), and/or other reference documents on nonresidential water use. To estimate water demands, designers should use these planning guides together with documented water-use records for existing facilities within the water system, or comparable uses at other water systems.

The design engineer should identify the specific existing, known, and planned buildings and building sites that comprise the current and future customers of a commercial, industrial, or public facility water system. A table summarizing the MDD and PHD of each building will assist us in summarizing the scope of our design approval. The design engineer should also provide an estimate of the total maximum daily population served.

Chapter 4 discusses documenting physical capacity for water systems serving primarily commercial, industrial, and/or public facilities.

3.6.3 Farming and Crop Irrigation Demand

Engineers should consult with the local Cooperative Extension office when determining water-use estimates for farms. It may be possible to find water-use records for various farm practices in the area. Table 3-2 provides some water-use references by type and number of livestock. Irrigation needs can be extremely variable and may require additional investigation. View an index of local extension offices at <http://extension.wsu.edu/locations>.

Some variables that influence water demands for farming and crop irrigation are:

- Type of farm.
- Number and type of animals it produces.
- Type of crops it grows.
- Weather conditions.
- Geographic location.

3.6.4 Recreational Development Demand

“Recreational development” applies to facilities that individuals and families intend to use for vacations or holidays away from their normal place of residence. There is a full spectrum of recreational development types. Some are simple campsites suitable for tents or trailers in a manner similar to a state campground, while others may be an elaborate community of rustic housing equipped with most, if not all, the amenities of urban living. The design engineer should identify in the design submittal the specific buildings (e.g., camp lodge, bath/shower, and dining hall), designated locations (e.g., camp sites, RV sites), and the total maximum daily population the system expects to serve.

Recreational developments may be eligible for reduced water system design criteria if they meet certain conditions. Reduced design criteria will apply only to sites intended solely for recreational occupancy. No permanent residential dwelling or structure, no matter how small, how simple, or how rustic, is permitted on a site designated for recreational uses. Engineers **must** design recreational development water systems that will serve residential dwellings not otherwise restricted from full-time occupancy consistent with demand values associated with permanent residences (WAC 246-290-221(2)).

We will consider reduced-design criteria if the project report and construction documents for a recreational development can demonstrate all of the following:

1. There are clearly defined sites for each occupant. Recreational developments can define sites by surveyed lot lines, permanent site markers, or surveyed-site centerlines drawn on a map that identifies the location of each site.
2. The acknowledged purpose of the recreational development is to provide space for short-term, transient, or seasonal use only.
3. Residential dwellings are restricted from full-time occupancy.
4. We received satisfactory documentation of claims made with respect to items 1–3 above. This may include a notation of the restrictions on the face of the plat, in covenants filed with the plat, or in individual deeds.

Ownership and operation of recreational developments vary along a wide spectrum. Some recreational developments operate on a membership basis while others sell facilities lot-by-lot, as in an ordinary residential plat. Recreational development water system owners that receive approval for reduced design criteria must operate their system within the approved design parameters. Ownership concentrated in a single decision-maker will have greater flexibility and capacity to ensure consumer demands do not exceed the design assumptions. Diffuse ownership (such as each lot owner in an association) may limit the ability to restrict customer demands during operation. In responding to designs submitted for a recreational development water system under

diffused ownership, we may request additional documentation on the owner's authority to enforce water use consistent with design assumptions and on the owner's plans to respond to water shortages.

Design engineers can use Table 3-2 and other design references such as the UPC fixture method and Ecology's wastewater flow tables (WSDOE 2008) to provide daily water use estimates for typical recreational and other nonresidential facilities.

No matter the source of information, the design engineer should base the MDD for recreational development water systems serving structures with internal plumbing suitable for short-term occupancy (such as overnight transient accommodation RVs and cabins) on **all** of the following:

- No less than 140 gpd per site or lot.
- Full (site) occupancy.
- All other water uses including swimming pools, irrigation, water features, and commercial buildings.

The maximum daily demand to peak hourly demand peaking factor values in Figure 3.1 apply to water systems serving recreational demands. We derived the two curves in Figure 3.1 from Equation 3-1, applying 140 gpd and 300 gpd estimated maximum daily demand per recreational unit. The graph reveals that differences in recreational unit MDD have little bearing on the peaking factor.

After identifying the unit MDD and the number of units, the designer can estimate the total estimated MDD. Using the graph and Eq. 3-2 below, designers can then estimate the system-wide PHD.

Equation 3-2:

$$\text{PHD}_{\text{recreational}} = (\text{MDD} \div 1440) \times \text{PF}$$

- Where**
- PHD** = Peak hourly demand, total system (gallons per minute)
 - MDD** = Maximum daily demand, including DSL, total system (gallons per day)
 - PF** = MDD to PHD peaking factor, from Figure 3.1

Figure 3.1
Recreational Water System
Maximum Daily Demand to Peak Hourly Demand Peaking Factor

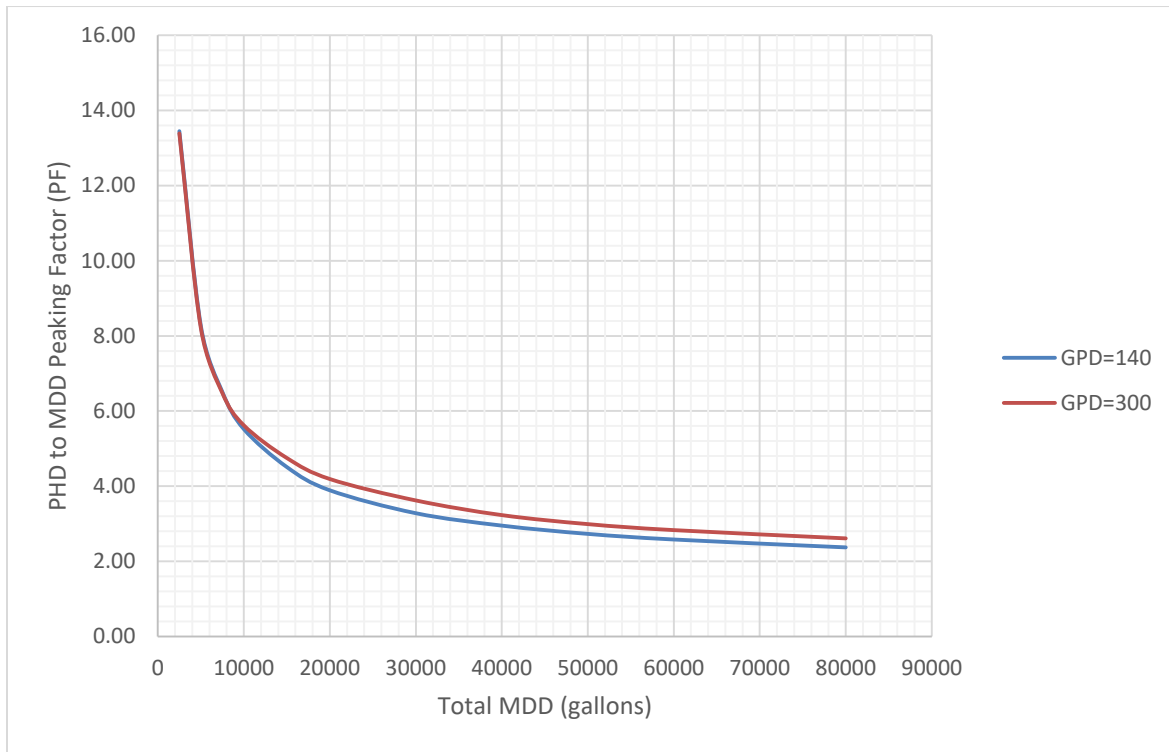

3.6.5 Anticipating Changes in Demand: Systems with Mostly Nonresidential Demand

Water demand estimates for noncommunity systems should address anticipated changes as a water system matures and business needs change. Changes in future water demands likely will reflect changes nonresidential facilities make in the type and level of business they do.

The analysis should address how future water-use may evolve without any change in the number of structures or spaces. For example, a concert venue may become more popular than anticipated, a place of work may add a second shift, the irrigation or recreational water demands on the system may increase as the clientele of a facility change, or a change in facility use may change water demand (e.g., a warehouse may become a brewery and restaurant).

Adjustments to any established design criteria should reflect actual or anticipated design conditions. These adjustments should provide a realistic margin of safety for reasonably anticipated demand increases. For some projects, water system demand, standby storage and/or fire suppression storage needs may exceed the engineer’s initial

estimate. This could occur when a water system experiences higher-than-expected growth or higher or lower service demand due to changing economic and demographic influence. It also could occur when uses change among existing customers.

Part 3: General Considerations

3.7 Establishing Needed Fire Flow

The local fire protection authority or county fire marshal usually determines minimum fire flow requirements (WAC 246-290-221(5)). Design engineers should always confirm the fire suppression requirements associated with a given water system design with the local fire protection authority or county fire marshal.

3.8 Factoring Distribution System Leakage (DSL) in Design

Water use efficiency (WUE) requirements apply to municipal water suppliers. In general, municipal water suppliers are community water systems with 15 or more residential service connections. Some noncommunity water systems that serve water in a residential manner to 25 or more people at least 60 days per year (such as a second home community) are municipal water suppliers. We make this determination on a case-by-case basis. For more information on WUE requirements, see the [Water Use Efficiency Guidebook](#) (DOH 331-375) or contact the appropriate [regional planner](#).

Municipal water suppliers **must** meet certain leakage standards to minimize water lost through distribution system leaks. Most municipal water suppliers that lose more than 10 percent of the water they produce through DSL **must** take action to reduce their leakage (WAC 246-290-820).

Design engineers cannot use projections of water savings resulting from future leak detection and repair, or from future implementation of planned WUE measures, when establishing the design criteria for an expanding water system (WAC 246-290-221).

Design engineers **must** establish sizing criteria that account for water system demands during the highest demand periods, including DSL (WAC 246-290-222). The design information should be sufficient to estimate peak hourly demand (PHD) and MDD for the built-out condition. Equation 3-3 is from WAC 246-290-820:

Equation 3-3:

$$\text{DSL} = \text{TP} - \text{AC}$$

Where:

DSL = Distribution system leakage (gallons per day)

TP = Total water produced and purchased over a full year, divided by 365 (gallons per day)

AC = Authorized consumption over a full year, divided by 365 (gallons per day).

Authorized consumption is the volume of metered and unmetered water that consumers and other authorized users use. Authorized uses include, but aren't limited to, firefighting and training, flushing water mains and sewers, street cleaning, and watering of parks and landscapes. These volumes may be billed or unbilled.

Water system production "lost" through DSL is no longer available for customer service. As such, DSL reduces a water system's ability to serve customers. A water system can increase its ability to serve more customers by reducing DSL. Some DSL will occur, even in very well maintained and managed water systems. For most water systems, it is impractical to eliminate all DSL (AWWA 2006). DSL is a demand component of every water system, and designers should include it with the water system capacity assessment. See Chapter 4.

For water systems, several factors influence the real water losses that are part of DSL, including:

- Number of service connections.
- Length of water mains.
- Average operating pressure.
- Infrastructure condition (Thornton 2002; AWWA 2006).

Because these factors are independent of demand, DSL is more likely to be consistent on a volume basis than on a percentage basis throughout a given year. Engineers can use the most recent three-year average annual volume of DSL and divide by 365 to identify a daily DSL volume.

3.9 Water Resource Issues

Competition over the state's water resources by a growing population, natural resource interests, and a vibrant economy is steadily increasing. The Department of Ecology manages the state's water resources, implementing a regulatory program for allocation of those resources, and enforcing its provisions.

For designs involving new or expanding sources, or increases in water system capacity, engineers **must** address water rights as a part of a submittal to us (WAC 246-290-100(4)(f), 105(4)(e), 110(4)(e), 120(7), 130(3), and 132(3)(b)). In these submittals, the engineer must complete a [Water Rights Self-Assessment Form](#) as part of the water rights analysis unless noted otherwise. Ecology uses the project information on this form to assess whether the project and its associated water system demands match certain limits specified on a water system's water right permit, certificate, or claim.

3.10 Source Adequacy and Reliability

The water system design frames the operational expectations and establishes the system's adequacy and reliability to meet consumer demands. State rules require water systems to maintain a minimum level of service during normal (nonemergency) operating conditions (WAC 246-290-420). Consumers have a reasonable expectation to an adequate supply of water not just during average conditions but also during high demand periods. Design assumptions about source adequacy and reliability have a significant effect on the ability of the water system to meet future regulatory obligations and consumer expectations.

3.10.1 Design and Operating Requirements

Design engineers **must** design water systems to provide at least 30 psi throughout the distribution system during peak hourly demand conditions (WAC 246-290-230). Water systems **must** operate with pressure throughout the distribution system maintained at or above the approved design pressure (WAC 246-290-420). A system affected by periodic drought or administrative restriction on withdrawal may have to impose restrictions on demand to maintain pressure.

3.10.2 Surface Water Source Reliability

The reliability of a surface water source depends on environmental factors such as rainfall, snowpack, and runoff rates during drought conditions. Climate change may amplify these factors, making it even more important for design engineers to consider the need for resiliency in the face of changing conditions over the life of the water

system. Source reliability also may depend on legal restrictions to withdraw water, or on the design and maintenance of the source infrastructure, such as a raw water impoundment. We can express source reliability by how frequently a water system expects normal demand to go unmet, such as a one-in-50 year or even a one-in-100 year drought.

We consider 98 percent source reliability an appropriate design standard for evaluating a watershed's capacity. This implies that consumers should expect water system-imposed restrictions on water use to occur on average once every 50 years. The design engineer should assess the duration of the once in 50-year water supply restriction during the design and the water system's water shortage response plan should address it. Additional information on assessing the reliability of surface water supplies is in Chapter 5.

If the design engineer adopts a lesser reliability standard, the system expects its consumers to accept a greater frequency of insufficient supply and more frequent mandatory demand curtailment. In this context, reliability becomes a balance between consumer expectations and the cost of meeting such expectations. The design engineer should document and provide engineering justification for the source reliability factor selected. See Section 4.4.2.3.

3.10.3 Groundwater Source Reliability

Groundwater source reliability depends on environmental factors, such as rainfall and hydrogeologic characteristics of the aquifer. Groundwater source reliability also may depend on legal restrictions to withdraw water, such as a Department of Ecology requirement to interrupt well withdrawal during low-flow periods in a nearby stream. As with surface water, we can express groundwater source reliability by how frequently a water system expects normal demand to go unmet, such as once-in-a-50 year, or even once-in-a-100 year interval interruption.

For wells subject to interruption due to low stream flow, we recommend that designers use a once-in-50-year interval as the basis for establishing reliance on the source to meet normal water system demand. This implies that consumers should expect water system-imposed restrictions on water use to occur on average once every 50 years.

The selected pump-test protocol (see Appendix E) should identify the aquifer safe yield. Based on the pump test protocol and quality of data, the design engineer should apply an appropriate factor of safety (e.g., multiply pump test results by 0.85) when calculating

safe yield to account for unknown hydrogeologic conditions and future climatic conditions.

3.10.4 General Safety Factor and Contingency Planning

We recommend against designs based on pumping 24-hours per day to meet future MDD. Designing or evaluating a system with some period of no pumping to satisfy projected MDD, provides a factor of safety and an increased ability to meet unexpected demands. We recommend assessing source capacity based on an assumption of pumping a source no more than 20 hours per day.

Source adequacy and reliability are important long-range planning elements and water systems **must** address them in water shortage response plans (WAC 246-290-100(4)(f) and -415(2)(d)). Plans to ensure long-range water system adequacy and reliability should address:

- Water-shortage response activities, such as accessing alternative water supplies and notifying us.
- Long-term adequacy of water rights for meeting the water system's growth expectations.
- Conservation as a mitigating practice to reduce the frequency or degree of curtailment.
- Water resource trends (such as declining aquifer levels, declining dry period stream flows, establishing in-stream flow requirements, and increasing salt water intrusion).

3.10.5 Summary of Water Supply Reliability Recommendations

Recommendations for source and water system reliability appear in various chapters of this manual. The following is a brief summary of our recommendations for water supply reliability.

1. Two or more supply sources are available.
2. Permanent and seasonal sources are capable of replenishing depleted fire suppression storage within 72-hours (continuous, 24-hour source pumping may be assumed for replenishment), or sooner if the local fire authority requires it, while concurrently supplying the MDD for the water system.
3. Permanent and seasonal source capacity is enough to supply MDD in a pumping period of 20 hours or less.
4. With the largest source out of service, the remaining permanent and seasonal sources can provide a minimum of ADD for the water system.

5. Source of supply pump stations have power connections to two independent primary public power sources, have in-place auxiliary power available (auto transfer capable), and/or maintain adequate gravity standby storage (see Chapter 7).
6. The firm watershed yield for surface water sources provides 98 percent reliability to meet normal, anticipated system demands.
7. A factor of safety is applied to a well pumping test safe yield determination.

3.11 Factor of Safety

We support the design of robust and resilient water systems based on the best available demand data. Without reliable and applicable demand information, we expect design engineers to apply their professional judgment and to document their assumptions. Despite using even the best available information, uncertainty about future conditions and validity of assumptions will persist. That is why we recommend using a factor of safety (FS) when designing water systems.

Using an appropriate FS is common in the engineering profession. Below we describe in general terms the range of FS given the degree of confidence the design engineer has in the data, and the scope of design assumptions.

- Mostly or entirely confident: FS = 1.10 to 1.15
- Somewhat confident: FS = 1.15 to 1.25
- Mostly uncertain: FS = 1.25 to 1.5

3.12 Example Exercises for Estimating Water System Demand

To illustrate the standards and concepts we describe in this chapter, we offer the following examples. These examples are not a recipe for design engineers. All reference to water rights assumes prior verification from the Department of Ecology.

3.12.1 New Community Water System

Known: Planned 100-lot subdivision with ½ to 1 acre lots. All lots will have single-family residential homes expected to have at least 3,000 square feet of living space. The subdivision is located in Benton County. Average annual rainfall for the project location is 9 inches per year. The soil is sand.

Find: ADD, MDD, PHD, ERU_{ADD} , and ERU_{MDD}

Solution:

1. Reference information in Appendix D.
2. Mostly confident in Appendix D ADD information. Apply FS to ERU_{ADD} of 1.10
3. $ERU_{ADD} = [8,000 \div 9] + 200 = 1,090 \text{ gpd} \times 1.1 = 1,200 \text{ gpd}$
4. Assume future DSL to be 10 percent of annual consumption. $DSL = 1,200 \times 100 \text{ connections} \times 0.10 = 12,000 \text{ gpd}$
5. Total system-wide ADD = annual consumption plus DSL. $[1,200 \text{ gpd} \times 100] + 12,000 \text{ gpd} = 132,000 \text{ gpd}$. Use 130,000 gpd.
6. Qa on the water right needs to provide at least $130,000 \text{ gpd} \times 365 \text{ days per year} = 47.5 \text{ MG per year}$. (1 acre-foot = about 326,000 gallons. Therefore, 47.5 MG = 146 ac-ft.)
7. Determine ERU_{MDD}. Select an ERU_{MDD} to ERU_{ADD} peaking factor of 2.0 as recommended in Appendix D.
8. Mostly uncertain in Appendix D MDD to ADD peaking factor for Eastern Washington. Apply FS to peaking factor of 1.3.
9. $ERU_{MDD} = 1,200 \times 2 \times 1.3 = 3,120 \text{ gpd}$
10. Translate DSL into ERUs. $12,000 \text{ gpd} \div 3,120 = 3.8 \text{ ERUs}$. Total number of ERUs, "N," supplied by sources equals $100 + 3.8 = 104$
11. Total system-wide MDD = $[3,120 \times 100 \text{ connections}] + 12,000 = 324,000 \text{ gpd}$
12. Design source pumping capacity to meet MDD in 20 hours (Section 3.10.4):
 $324,000 \text{ gpd} \div 1,200 \text{ min per day} = 270 \text{ gpm}$
13. Qi on the water right needs to provide at least $325,000 \text{ gpd} \div 1,440 = 225 \text{ gpm}$. Ideally, Qi is at least 270 gpm.
14. Use Equation 3-1 to determine PHD

$$PHD = [(3,120 \div 1,440) \times (2.5 \times 104 + 25)] + 18 = 630 \text{ gpm.}$$

3.12.2 Expanding (Existing) Community Water System

Known: An existing 100-lot subdivision has ¼-acre lots. All services are single-family residential dwellings. The existing subdivision was fully built-out by the mid-1990s. Proposal is to add 200 additional single-family residential ¼-acre lots. All homes are primary residences, and occupied on a full-time basis. The existing system is in Klickitat County.

DSL is indeterminable due to incomplete service metering.

Most water systems record monthly source production. The maximum monthly production for the past 10 years is as follows (from oldest to most recent): 4.1 MG, 3.4 MG, 3.2 MG, 3.0 MG, 2.5 MG, 2.2 MG, 2.3 MG, 2.2 MG, 2.0 MG, and 2.5 MG. Further

investigation into oldest maximum monthly production data (4.1 MG) reveals two anomalies: Undetected failure of the reservoir control system, resulting in significant waste of water through a prolonged reservoir overflow; and a nearby wildfire that the local fire authority suppressed by using the community water supply.

Annual production for the past 10 years is as follows (from oldest to most recent): 26 MG, 22 MG, 20 MG, 20 MG, 19 MG, 19 MG, 18 MG, 18 MG, 16 MG, 17 MG and 17 MG. Average climatic conditions prevailed during this period, and there were no restrictions imposed on water use.

Find: ADD, MDD, PHD, ERU_{ADD} , and ERU_{MDD} for the proposed expanding water system

Solution:

1. Discard first year data for monthly and annual source production volume.
2. Apply a factor of safety of 1.10 to the annual and maximum monthly production data, based on a high degree of confidence in the remaining data set.
3. Annual production data reflects a trend toward lower production with time. Use 17 MG per year to determine future ERU_{ADD} . $17 \text{ MG} \times 1.10 = 18.7 \text{ MG}$.
4. Assume DSL to be 10 percent of annual production. $DSL = 1.9 \text{ MG/year}$
5. Annual consumption = Production – DSL = $18.7 \text{ MG/yr.} - 1.9 \text{ MG/yr.} = 16.8 \text{ MG/yr.}$
6. $ERU_{ADD} = [16.8 \text{ MG/yr.}] \div 100 \div 365 = 460 \text{ gpd}$
7. Maximum monthly production for the past three years does not indicate any trend. Use high value = 2.5 MG/month to determine ERU_{MDD} . $2.5 \text{ MG} \times 1.10 = 2.75 \text{ MG}$
8. Maximum monthly consumption = Max monthly production – DSL (monthly volume)
 $2.75 \text{ MG} - [1.9 \text{ MG} \div 12] = 2.6 \text{ MG}$
9. $ERU_{MDD} = [2.6 \text{ MG} \times 1.65 \text{ peaking factor (see Section 3.4.1)}] \div 100 \div 32 \text{ days between measurements} = 1,340 \text{ gpd}$
10. Translate existing DSL into ERUs. $[1.9 \text{ MG/yr.} \div 365] \div 1340 = 3.9 \text{ ERUs}$. Use 4
11. Future DSL will be proportional to the number of lots served because the distribution system is expanding proportionately.
12. Future number of ERUs = $300 + 12 = 312$
13. Total future system-wide ADD = $[300 \times 460 \text{ gpd}] + [(1.9 \text{ MG} \times 3) \div 365] = 154,000 \text{ gpd}$. Use 155,000 gpd

14. Q_a on the water right needs to provide at least $155,000 \text{ gpd} \times 365 \text{ days per year} = 56.5 \text{ MG per year}$ (173 ac-ft./yr.).
15. Total future system-wide MDD = $[300 \times 1,340 \text{ gpd}] + [(1.9 \text{ MG} \times 3) \div 365] = 418,000 \text{ gpd}$.
16. Design source pumping capacity to meet MDD in 20 hours (Section 3.10.4):
 $418,000 \text{ gpd} \div 1200 \text{ min per day} = 350 \text{ gpm}$
17. Q_i on the water right needs to provide at least $418,000 \text{ gpd} \div 1440 = 290 \text{ gpm}$. Ideally, Q_i is at least 350 gpm.
18. Use Equation 3-1 to determine PHD
$$\text{PHD} = [(1,340 \div 1,440) \times (1.8 \times 312 + 125)] + 18 = 660 \text{ gpm}$$

3.12.3 New Mixed-Use Community Water System

Known: Proposed new planned unit development with 100 1-acre single-family home lots, 2-acre community park, and a 100-unit RV park. The subdivision is in Benton County. Average annual rainfall for the project location is 9 inches per year.

Find: ADD, MDD, PHD, ERU_{ADD} , and ERU_{MDD}

Solution:

1. Reference information in Appendix D.
2. Mostly confident in Appendix D ADD information. Apply FS to ERU_{ADD} of 1.10
3. $ERU_{ADD} = [8,000 \div 9] + 200 = 1,090 \text{ gpd} \times 1.1 = 1,200 \text{ gpd}$
4. Determine ERU_{MDD} . Select an ERU_{MDD} to ERU_{ADD} peaking factor of 2.0 as recommended in Appendix D.
5. Mostly uncertain in Appendix D MDD to ADD peaking factor for Eastern Washington. Apply FS to peaking factor of 1.3.
6. $ERU_{MDD} = 1,200 \times 2 \times 1.3 = 3,120 \text{ gpd}$
7. Irrigation of the 2-acre community park: Use 180 gpd per 1,000 sf (Table 3-2) and assume 182 days of irrigation per year.
 - a. $180 \times (2 \times 43,560) \div 1,000 = 15,681 \text{ gpd} \times 182 \text{ days} = 2.85 \text{ MG (annual)}$
 - b. MDD for park irrigation is 15,681. Use 16,000 gpd.
8. 100-unit RV park consumptive demand estimated at 140 gpd/unit (see Table 3-2). Assume the RV park is 100% occupied during the spring, summer, and fall; closed during the winter months.
9. Annual consumption.
 - a. Single-family homes = $1,200 \times 100 \text{ connections} \times 365 = 44 \text{ MG}$

- b. Community park irrigation = 2.85 MG
 - c. RV park = 100 units x 140 gpd/unit x 100% occupancy x (365 x 0.75) = 3.8 MG
 - d. Total annual consumption = 50.6. Use 51 MG
10. Average daily consumption = 51 MG ÷ 365 = 140,000 gpd
 11. Assume DSL to be 10 percent of annual consumption. DSL = 140,000 x 0.10 = 14,000 gpd
 12. Total system-wide ADD = 140,000 + 14,000 = 154,000 gpd
 13. Qa on the water right needs to provide at least 154,000 gpd x 365 days per year = 56 MG per year (171 ac-ft./yr.)
 14. Translate DSL into ERUs. 14,000 gpd/3,120 = 4.4 ERUs
 15. Determine total number of ERUs, "N," supplied by sources
 - a. 100 SFHs = 100
 - b. DSL = 4.4
 - c. Community park = 16,000 ÷ 3,120 = 6.4
 - d. RV park = 100 units x 140 gpd/unit = 14,000 ÷ 3,120 = 4.4
 - e. Total number of ERUs, "N" = 115. System is predominantly residential.
 16. Total system-wide MDD = (100 x 3,120) + 16,000 + 14,000 + 14,000 (DSL) = 356,000 gpd
 17. Design source pumping capacity to meet MDD in 20 hours (Section 3.10.4): 356,000 gpd ÷ 1,200 min per day = 297 gpm. Use 300 gpm
 18. Qi on the water right needs to provide at least 356,000 gpd ÷ 1,440 = 247 gpm. Ideally, Qi is at least 300 gpm.
 19. Use Equation 3-1 to determine PHD
 - a. PHD = [(3,120 ÷ 1,440) x (2.0 x 115 + 75)] + 18 = 680 gpm.

3.12.4 Expanding Mixed-Use Community Water System

Known: Existing 100-lot subdivision built-out in the 1980s with 1-acre lots. The existing system is on Bainbridge Island. All services are single-family residential.

The proposal is to add 200 additional single-family residential lots on ¼-acre lots, a 2-acre community park, and a 100-unit RV park.

The three-year average DSL was calculated at 15 percent. Monthly source production is recorded. Service meters are read every two months. Through a survey the water system

determined that 40 homes are currently used as seasonal residences (summer only), and 60 homes are occupied on a full-time basis.

Annual production for the past 5 years is as follows (from oldest to most recent): 16 MG, 13 MG, 17 MG, 18 MG, and 16 MG. Annual consumption of the 60 permanent homes has been 7 MG, 7 MG, 8 MG, 9 MG, and 7 MG.

Peak bimonthly consumption data for the past 5 years (from oldest to most recent): 4.3 MG, 4.5 MG, 4.4 MG, 4.2 MG, 4.1 MG. The peak bimonthly consumption data of the 60 permanent homes has been 2.7 MG, 2.8 MG, 2.6 MG, 2.5 MG, and 2.5 MG.

Find: ADD, MDD, PHD, ERU_{ADD} , and ERU_{MDD} for the proposed expanding water system.

Solution:

1. Mostly confident in the water system's annual production and bimonthly consumption data. Apply a FS = 1.10.
2. Annual production and consumption data does not reflect a trend toward lower withdrawal over time. Use 18 MG. $18 \times 1.10 = 19.8$ MG. Use 20 MG
3. DSL was calculated at 15 percent.
 - a. $DSL = 20 \text{ MG/yr} \times 0.15 = 3 \text{ MG/yr}$.
4. Use annual consumption of 60 permanent homes to estimate ERU_{ADD} . Data does not reflect a trend toward lower peak bimonthly consumption over time. Use $9 \text{ MG} \times 1.10 = 10 \text{ MG}$
 - a. $ERU_{ADD} = 10 \text{ MG} \div 60 \text{ homes} \div 365 \text{ days} = 457 \text{ gpd}$
5. Use peak bimonthly consumption of 60 permanent homes to estimate ERU_{MDD} . Data reflects a trend toward lower peak bimonthly consumption over time. Use 2.5 MG and peaking factor of 1.65 (see Section 3.4.1).
 - a. $ERU_{MDD} = 2.5 \text{ MG} \times 1.10 \div 60 \text{ homes} \div 60 \text{ days} = 763 \times 1.65 = 1,260 \text{ gpd}$.
6. Translate existing DSL into ERUs. $[3 \text{ MG/yr} \div 365] \div 1,260 = 6.5 \text{ ERUs}$.
7. Assume DSL is proportional to size of the distribution system. Future DSL will be 1.6 times existing DSL because the distribution system is expanding by 60 percent. Future DSL ERUs = $6.5 \times 1.6 = 10 \text{ ERUs}$
8. Future annual consumption:
 - a. 100 existing single-family homes: $457 \text{ gpd/ERU} \times 100 \times 365 = 16.7 \text{ MG}$
 - b. 200 new homes: Use a 20% reduction in ERU_{ADD} because of smaller lot size supported by analogous system data (meeting the analogous system data standards in Section 3.2.3): $200 \times 457 \text{ gpd/ERU} \times 0.8 \times 365 = 26.7 \text{ MG}$

- c. Community park irrigation: Use 180 gpd per 1,000 sf (Table 3-2) and assume 100 days of irrigation.
 - i. $180 \times (2 \times 43,560) \div 1,000 = 15,681 \text{ gpd} \times 100 \text{ days} = 1.57 \text{ MG}$
 - d. RV park: 140 gpd/unit (see Table 3-2). Assume the RV park is 80% occupied during the spring, summer, and fall; closed during the winter months.
 - i. $100 \text{ units} \times 140 \text{ gpd/unit} \times 0.80 \text{ (occupancy)} \times 365 \times 0.75 = 3 \text{ MG}$
 - e. $\text{DSL} = 3 \text{ MG} \times 1.6 = 4.8 \text{ MG}$
 - f. Total future annual production requirement = 53 MG per year
 - g. Future system-wide ADD = $53 \text{ MG} \div 365 = 145,000 \text{ gpd}$
9. Qa on the water right needs to provide at least 53 MG per year.
10. Future maximum daily consumptive demands:
- a. 100 existing single-family homes: $1,260 \text{ gpd/ERU} \times 100 = 126,000 \text{ gpd}$
 - b. 200 new homes: Use a 30% reduction in ERU_{MDD} because of smaller lot size supported by analogous system data (meeting the analogous system data standards in Section 3.2.3): $200 \times 1,260 \text{ gpd/ERU} \times 0.7 = 176,000 \text{ gpd}$
 - c. Park irrigation MDD is 15,681. Use 16,000 gpd
 - d. RV park: $140 \text{ gpd/unit} \times 100 \text{ units} = 14,000 \text{ gpd}$
 - e. $\text{DSL} = 4.8 \text{ MG} \div 365 = 13,000 \text{ gpd}$
 - f. Future system-wide MDD = 345,000 gpd. The system is predominantly residential.
11. Future number of ERUs:
- a. Existing homes = 100 ERUs
 - b. New homes = $176,000 \div 1,260 = 140 \text{ ERUs}$
 - c. Park = $16,000 \div 1,260 = 12.7 \text{ ERUs}$
 - d. RV Park = $14,000 \div 1,260 = 11.1 \text{ ERUs}$
 - e. $\text{DSL} = [4.8 \text{ MG} \div 365] \div 1,260 = 10.4 \text{ ERUs}$
 - f. Total future ERUs = 274 ERUs
12. Design source pumping capacity to meet MDD in 20 hours (Section 3.10.4): $345,000 \text{ gpd} / 1,200 \text{ min per day} = 288 \text{ gpm}$. Use 290 gpm
13. Qi on the water right needs to provide at least $345,000 \text{ gpd} \div 1,440 = 240 \text{ gpm}$. Ideally, Qi is at least 290 gpm.
14. Use Equation 3-1 to determine PHD
- a. $\text{PHD} = [(1,260 \div 1,440) \times (1.8 \times 274 + 125)] + 18 = 560 \text{ gpm}$

3.12.5 Expanding Noncommunity Water System

Known: A single 120-gpm well (no storage) supplies an existing 200-unit RV park, convenience store, service station, a water park, and about 1 acre of irrigated lawn and garden. The existing facilities have been in service for the past two years. The park owner states the park is closed November 1 through April 1 each year. The park is in Spokane County. There are no residences. Average occupancy has been 80 percent during the 7 months the park is open.

Year 1 and year 2 annual water production was 3.0 MG and 3.5 MG, respectively. The well is metered and equipped with a variable speed drive submersible pump. The system has only pressurized storage. There are no service meters.

Year 1 maximum monthly production was recorded as 0.6 MG, and year 2 was 0.7 MG. Anecdotally, the owner indicated that the system has always maintained at least 30 psi throughout the distribution system, even during extreme demand events.

The owner wants to add 150 additional RV spaces, each with water and sewer connections, a laundromat, and another 1-acre of grassy area.

Find: ADD, MDD, PHD

Solution:

1. Mostly uncertain about the water system's annual production and bimonthly consumption data. Apply a FS = 1.4 due to the limited amount of data, and certain variables still untested over an extended timeframe.
2. The existing system's estimated ADD: $[3.5 \text{ MG} \times 1.4] \div 213 \text{ days (7 months)} = 23,000 \text{ gpd}$.
3. The existing system's MDD can be estimated as follows:
 - a. $[0.7 \text{ MG} \times 1.4] \div 31 = 31,600 \text{ gpd} \times 1.7 \text{ MMADD to MDD peaking factor for the RV park (see Section 3.4.1)} = 54,000 \text{ gpd}$
4. The existing system's PHD is estimated as $(54,000 \div 1440) \times 2.8 \text{ peaking factor (see Figure 3-1 and Equation 3-2)} = 105 \text{ gpm}$
5. Maximum daily demand of proposed new uses:
 - a. MDD of each new RV space is estimated at 140 gpd (see Table 3-2) $\times 150 = 21,000 \text{ gpd (full occupancy)}$.
 - b. MDD of laundromat based on an estimate that it will service 20% of RV occupants each day. MDD of the laundromat is 50 gals (See Table 3-2) $\times 0.20 \times 300 \text{ RV spaces} = 3,000 \text{ gpd}$.

- c. Irrigation to 1-acre grassy park estimated at 180 gpd per 1,000 sf (See Table 3-2).
 - i. $[180 \times 43,560] \div 1,000 = 7,840$ gpd. Use 8,000 gpd
- 6. Future Annual Consumption:
 - a. $23,000 \times 213$ days/yr. = 5.5 MG
 - b. $21,000 \times 0.8$ occupancy $\times 213$ days/yr. = 3.6 MG
 - c. $3,000 \times 0.8$ occupancy $\times 213$ days/yr. = 0.5 MG
 - d. $8,000 \times 180$ days irrigation/yr. = 1.4 MG
 - e. Total = 11 MG
- 7. Future MDD:
 - a. $54,000 + 21,000 + 3,000 + 8,000 = 86,000$ gpd
- 8. Future PHD is estimated as $(86,000 \div 1,440) \times 2.5$ peaking factor (see Figure 3-1 and Equation 3-2) = 150 gpm
- 9. Since there is no storage, source production must meet PHD. Design source pumping capacity must be at least 150 gpm
- 10. Qi on the water right needs to provide at least 150 gpm
- 11. Qa on the water right needs to provide at least 11 MG

3.12.6 Assessing Full- and Part-Time Residential Use

Known: The 200-home built-out community is a mixed primary and secondary home community. It is a summertime community, as indicated by comparing monthly source production data over the past 5 years. The peak month for production is July or August.

Three wells supply the water system. The system has a single reservoir with an external gauge indicating reservoir level. All three sources are metered, and source meters are read every month. All homes have service meters, and service meters are read every two months.

Fourth of July falls on a Saturday and Labor Day falls on September 7.

Find: (1) ERU_{MDD} based on full-time occupancy.
 (2) ERU_{ADD} based on full-time occupancy.

Approach:

Estimate ERU_{MDD} :

1. Help the water system prepare a plan to read each source meter and the reservoir level on Friday, July 3 and on Friday, September 4 (preholiday condition).
2. Help the water system prepare a plan to read each source meter and the reservoir level on Monday, July 6 and on Tuesday, September 8 (postholiday condition).
3. Help the water system identify a cohort of representative homes to do a drive-by survey during one of the afternoons and evenings of each study period. The number of homes surveyed should equal at least 25 percent of all homes. Determine the occupancy level of the entire community based on these observations.
4. Calculate the 3-day system demand over Fourth of July weekend and 4-day system demand over Labor Day weekend. Select the highest average daily demand for these periods and apply a factor of safety to account for peaking during the days subject to data collection.
5. Calculate ERU_{MDD} based on the source production (plus or minus reservoir level) and occupancy.
 - a. Multiply the number of homes (200) by the percent occupancy determined from the survey.
 - b. Divide the value determined in #4 above by the adjusted number of homes (reflecting occupancy). The calculated ERU_{MDD} will reflect DSL since source production data was used.

Estimate ERU_{ADD} :

1. Review the bimonthly service meter records of each customer and select customers that have two or more two-month periods of consumption that is less than 100 gpd per residence. You can assume seasonal or intermittent occupancy for these homes.
2. For all remaining homes, calculate the average daily consumption per residence. This is the $ERU_{ADD-FULLTIME}$ value based on consumption of the homes considered likely to be occupied full time.
3. Apply the $ERU_{ADD-FULLTIME}$ to all homes to determine system ADD.

From these ERU_{ADD} and ERU_{MDD} the design engineer can assess the capacity of the system based on full-time occupancy.

Example Solution for MDD FULLTIME:

1. The difference between source meter readings taken July 6 and July 3 was 320,000 gallons. The difference in the reservoir level was 5,000 gallons less on July 6. Among the 200 homes, 70 were surveyed. Among the 70 surveyed, 63 homes were observed to be occupied.
2. The difference between September 8 and September 4 source meter readings was 460,000 gallons. The difference in the reservoir level was 10,000 gallons more on September 8. Among the 200 homes, 60 were surveyed. Among the 60 surveyed, 48 homes were observed to be occupied.
3. July's 3-day period of use equates to:
 - a. $325,000 \text{ gal (production plus storage withdrawal)} \div [(63 \div 70 \text{ occupancy rate}) \times 200 \text{ homes} \times 3 \text{ days}] = 600 \text{ gpd per occupied residence.}$
4. September's 4-day period of use equates to:
 - a. $450,000 \text{ gal (production minus storage gain)} \div [(48 \div 60 \text{ occupancy rate}) \times 200 \text{ homes} \times 4 \text{ days}] = 700 \text{ gpd per occupied residence.}$
5. Select the higher calculated daily production per residence: 700 gpd per home
6. Mostly confident in the methodology and accuracy of the occupancy survey, reservoir level measurement, and source meter data. Apply a FS = 1.15.
7. $700 \times 1.15 = 800 \text{ gpd per residence.}$ This value includes DSL, since the primary data was source production.
8. MDD based on full-time occupancy is $800 \text{ gpd} \times 200 = 160,000 \text{ gpd.}$

Example Solution for ADD FULLTIME:

1. Total yearly production for 2011, 2012, and 2013 was 15 MG, 17 MG, and 20 MG
2. A review of 2011, 2012, and 2013 consumption data reveals the following:

Year	Homes < 100 gpd consumption 4+ months	Homes ≥ 100 gpd consumption for at least 8 months	Total consumption at homes ≥ 100 gpd for at least 8 months	ERU _{ADD} for homes ≥ consuming 100 gpd for at least 8 months
2011	115	85	10.8 MG	349
2012	105	95	10.6 MG	307
2013	90	110	14.5 MG	362

3. The results show no trend. Normal climatic conditions prevailed during this period. Select the higher calculated daily consumption per residence: 362 gpd per home
4. Mostly confident in the assumptions on threshold for fulltime occupancy (100 gpd per residence) and the accuracy of data collection. Apply a FS = 1.15.

5. $ADD_{FULLTIME} = 362 \times 1.15 = 416$ gpd per residence. This value excludes DSL, since the primary data was metered consumption.
6. Assume DSL at 10 percent of existing production. Therefore, $DSL = 20 \text{ MG} \times 0.1 = 2 \text{ MG}$.
7. Estimate of total annual production requirement under fulltime occupancy = $(416 \times 365 \times 200) + 2 \text{ MG} = 32 \text{ MG}$

References

- American Association for Vocational Instructional Materials. 1982. *Planning for an Individual Water System*, 4th Edition, American Association for Vocational Instructional Materials, Athens, GA.
- AWWA. 1984. *Design and Construction of Small Water Systems*, American Water Works Association, Denver, CO.
- AWWA. 2006. *Water Conservation Programs – A Planning Manual*. AWWA Manual M52. American Water Works Association, Denver, CO.
- AWWA. 2012. *Computer Modeling of Water Distribution Systems*, 3rd Edition. AWWA Manual M32. American Water Works Association, Denver, CO.
- Mayer, P.W., W.B. DeOreo, E.M. Opitz, J. C. Kiefer, W.Y. Davis, B. Dziegielewski, and J.O. Nelson. 1999. *Residential End Uses of Water*, AWWA Research Foundation and American Water Works Association, Denver, CO.
- Thornton, J. 2002. *Water Loss Control Manual*. McGraw-Hill, New York, NY.
- WSDOE. 2008. *Criteria for Sewage Work Design*, Chapter G-2: "General Considerations." Pub. # 98-37. Washington State Department of Ecology, Olympia, WA.
- WSDOH. 2017. *Water Use Efficiency Guidebook*, DOH 331-375, Washington State Department of Health, Olympia, WA.
- WSDSHS. 1973. *Design Standards for Public Water Supplies*, Washington State Department of Social and Health Services, Olympia, WA.
- WSDSHS. 1983. *Sizing Guidelines for Public Water Supplies*, Washington State Department of Social and Health Services, Olympia, WA.

Chapter 4: Water System Capacity Analysis

4.0 Introduction

The goal of every water system design should be adequate service capacity that reliably meets consumer demands with safe drinking water. This chapter presents concepts and tools to help you determine the service capacity of a water system. It presents service capacity analysis based on the physical limitations of the water system and legal and contractual limitations, such as water rights and intertie agreements.

Design engineers **must** assess the capacity of each system component, such as source, treatment, storage, transmission, or distribution, individually and in combination with each other (WAC 246-290-222). The goal is to provide water of adequate quality, quantity, and pressure during minimum supply and maximum demand scenarios.

Chapter 4 relies heavily on information and guidance presented in Chapter 3 where we introduced the concept of the equivalent residential unit (ERU). Capacity evaluations consider how much water the system can reliably produce and how many connections it can reliably serve with a quantity of water usually expressed in ERUs. While engineers evaluate water system capacity in ERUs, we record capacity as the total number of approved connections on the *Water Facilities Inventory* form (WFI). See Attachment A at the end of this chapter for assumptions made in the conversion between excess capacity expressed as ERUs and approved connections.

Water systems should establish and maintain a water budget to monitor remaining service capacity, expressed in either gallons per day or ERUs, so that the water system does not exceed physical capacity limitations and legal water use restrictions. Design engineers should be able to explain to the water system's governing body and system operator how they determined the system's service capacity. They also should be able to identify the limiting factor(s) and provide guidance on appropriate ways to track service capacity as the type and number of connections change over time.

We divided this chapter into two parts to distinguish between predominantly residential water systems and predominantly nonresidential systems. This is important because equivalent residential units cannot be used to assess the physical capacity of predominantly nonresidential systems.

- 1. Capacity Analysis for Residential Systems:** Focuses on systems where residential demands comprise a significant portion or all of the demand.

- 2. Capacity Analysis for Nonresidential Systems:** Focuses on systems where residential demands comprise an insignificant portion of total demand.

The Drinking Water Operating Permit Rule establishes criteria to determine water system service adequacy, including the maximum number of allowed connections (Chapter 246-294 WAC). If a water system exceeds its maximum number of allowed connections, its operating permit status will change from green to “category blue.” (WAC 246-294-040(2)(c)). You can find additional information on operating permits in our fact sheet on this subject ([DOH 331-168](#)).

Part 1: Capacity Analysis for Residential Systems

4.1 General Expectations

Design engineers **must** analyze water system service capacity in planning documents (WAC 246-290-100) and in certain project reports and engineering documents (WAC 246-290-110(4)(f)). The following examples illustrate when to complete an engineering analysis of physical capacity.

- An existing water system does not have DOH approval, and seeks a green operating permit.
- An existing water system, without an approved planning document, seeks an increase in the number of approved connections without the need for new source or storage infrastructure.
- Project construction is complete, but the constructed project components differ from the design we approved.
- A non-expanding water system wishes to provide service to a type of connection not identified in its planning document, or any previous project approvals.

4.2 ERUs, Connections, and Population

4.2.1 ERUs

An ERU is *a system-specific unit of measure used to express the amount of water consumed by a typical full-time single-family residence* (WAC 246-290-010). In Chapter 3, we explain how to calculate this unit value of demand. The physical capacity analysis **must** assess the water system’s ability to supply the maximum day demand (MDD) for the entire water system and verify that the water system can maintain adequate distribution system pressure under peak hourly demand (PHD) and under MDD plus fire

flow conditions where it provides fire flow (WAC 246-290-230). Physical capacity determinations for residential systems **must** be reported in ERUs (WAC 246-290-222(2)).

Many water systems serve a mixture of single and multifamily dwellings, commercial and industrial customers, and other users. The ERU is a tool to translate non-single-family residential demand into an equivalent value of demand on the system's infrastructure.

Although it is important to establish an appropriate ERU value, and we express water system service capacity in ERUs, water system owners and operators think in terms of "number of connections." And, they report connections on their *Water Facilities Inventory* form.

4.2.2 Connections Served

Each single-family home, each dwelling unit in a multifamily building, and each nonresidential building the water system serves is a connection.

This manual considers an accessory dwelling unit (ADU) a separate connection if the ADU is physically separate from the main residence. If the ADU is physically within the main residence, the ADU is not a separate connection.

The following examples illustrate application of "connection":

- A system serving eight duplexes and two single-family homes serves 18 dwelling units. Each dwelling unit is a connection.
- A system serving eight single-family homes, each with an accessory dwelling unit incorporated into the main structure of the home, serves a total of eight dwelling units, and therefore eight connections.
- A system serving eight single-family homes, each with an accessory dwelling unit built as a separate structure on the same parcel, serves a total of 16 dwelling units, and therefore 16 connections.
- **For noncommunity water systems:** Each recreational campsite, RV site, and overnight unit in a hotel or motel is a connection. For institutional facilities, commercial businesses, industrial properties, schools and other nonresidential service connections, each building with water service is a connection.
- **For community water systems:** Each direct service connection to nonresidential users such as campgrounds, RV parks, hotels, motels, businesses, and industrial parks is a connection.

The number of connections is important. We use it to:

- Determine the system classification (Group A or Group B) and type (community or noncommunity)
- Calculate the annual operating permit fee for Group A community systems.
- Describe excess service capacity (see Chapter 4 Attachment A).

The number of ERUs is important. We use it to calculate service capacity.

4.2.3 Population Served

When designing water systems, engineers need to consider the number of people that have *access* to piped water for human consumption. The population served is either the residential (people living in a residence) or nonresidential (tourists, customers, employees) customers entering the premises and given the opportunity to access tap water.

For design purposes, assign at least 2.5 residents to each dwelling unit. If a proposed system serves 10 or more dwelling units, we will review the design under the approval standards for Group A public water systems (see WAC 246-291-200). For design purposes, each residence **must** be considered a full-time residence unless there are formal restrictions established that prevent full-time use (WAC 246-290-221 (2)).

4.3 Applying the Concept of Equivalent Residential Units in Design

Most small water systems serve at least some and often only single-family residences. Single-family residential customers have a typical demand pattern. Nonresidential customers (such as an industry or business) may have demand patterns significantly different than single-family homes. See Section 3.6 for more information on estimating nonresidential demands.

Engineers **must** evaluate and design a water system by first translating nonresidential and multifamily consumer demands into an equivalent number of single-family residences that system serves or will serve (WAC 246-290-222). We created a few simple examples that illustrate how to apply the concept of ERUs in service capacity analyses.

Example 1: Basic ERU Conversion

A water system serves 100 single-family homes, a school, and a small business. After analyzing metered consumptive data for full-time occupied single-family

homes, the engineer determines that the ERU_{MDD} value for this system is 800 gpd. The estimated MDD of the school during the same high-demand period is 8,000 gpd, and the estimated MDD for the business is 1,600 gpd.

As summarized below, the 102 service connections this system supplies represent 112 ERUs.

- 100 homes = 100 ERUs
- School = $8,000 \text{ gpd} \div 800 \text{ gpd per ERU} = 10 \text{ ERUs}$
- Business = $1,600 \text{ gpd} \div 800 \text{ gpd per ERU} = 2 \text{ ERUs}$

Example 2: ERUs Associated with Multifamily Residences

A water system serves 200 single-family homes and 500 multifamily dwellings. After analyzing metered consumptive data for full-time occupied single-family homes, the engineer determines that the ERU_{MDD} value for this system is 700 gpd. This water system also serves 50 connections serving 500 multifamily dwellings. The engineer estimates that the MDD of the 50 multifamily service connections during the same high-demand period is 210,000 gpd.

As summarized below, the 250 service connections this system supplies represent 500 ERUs.

- 200 homes = 200 ERUs
- Multifamily dwellings = $210,000 \text{ gpd} \div 700 \text{ gpd per ERU} = 300 \text{ ERUs}$

Example 3: ERUs Associated with Nonresidential Customers

A water system serves 1,000 single-family homes, 50 small commercial businesses, and a food processing plant. After analyzing metered consumptive data for full-time occupied single-family homes, the engineer determines that the ERU_{MDD} value for this system is 600 gpd.

The estimated collective MDD of the 50 commercial businesses is 60,000 gpd, and the estimated MDD of the food processing plant is 360,000 gpd during the same high-demand period.

As summarized below, the 1,051 service connections this system supplies represent 1,700 ERUs.

- 1,000 homes = 1,000 ERUs
- Commercial Businesses = $60,000 \text{ gpd} \div 600 \text{ gpd per ERU} = 100 \text{ ERUs}$
- Food Processor = $360,000 \text{ gpd} \div 600 \text{ gpd per ERU} = 600 \text{ ERUs}$

The above examples are for illustrative purposes and do not account for ERUs associated with distribution system leakage (DSL). See Section 3.1 about the importance of factoring DSL into service capacity assessment.

4.4 Determining Water System Capacity

The following steps represent an approach for determining the physical capacity of a predominantly residential water system. Engineers may propose another approach supported by system-specific information and engineering justification. Engineers may summarize their capacity analysis information on Worksheet 4-1 (at the end of this chapter), or a similar form.

4.4.1 Step 1: Water Demands

Design engineers **must** estimate water demands (WAC 246-290-221). For systems serving different customer classes, you should create separate estimates for residential and nonresidential customers. For existing systems, design engineers should quantify MDD, ADD, ERU_{MDD} and ERU_{ADD} by using actual water consumption records. In designing a new water system, you may use water use from an analogous water system or the approach described in Appendix D. You should use Equation 3-1 to estimate PHD.

4.4.2 Step 2: Source Capacity

All water systems **must** have sufficient source capacity to meet MDD (WAC 246-290-222(4)). If total permanent and seasonal source capacity cannot satisfy total consumptive demands plus DSL, do not use the equations shown later in this chapter. Instead, the design engineer will need to perform an alternate analysis. Design engineers proposing to use storage to meet MDD should consult with the regional engineer on specific requirements before pursuing such a design.

In general, the total daily source capacity **must** be able to *reliably* provide sufficient water to meet the MDD for the water system (WAC 246-290-222(4)). If sources cannot meet or exceed PHD, then equalizing storage **must** be provided to meet diurnal demands that exceed source capacity (WAC 246-290-235(2)). See Chapter 7 for equalizing storage requirements. Sources **must** also meet minimum reliability requirements (WAC 246-290-420). See Chapter 5 for design guidance for sources.

Base total system source capacity on the capacity of permanent and seasonal sources (WAC 246-290-222). Design engineers **cannot** include emergency sources, including emergency interties, in the total source capacity calculations (WAC 246-290-222(3)).

Design engineers should document the approach used to assess source-based service capacity into the physical capacity analysis and all related assumptions: data acquired to determine full- and part-time residential, nonresidential, and non-revenue water demands; identifying DSL; and the source adequacy and reliability issues described in Section 3.10.

Design engineers should refer to the following information to determine source capacity. The most limiting element establishes the source-based service capacity.

- Water rights
- Pumping tests and groundwater reliability
- Surface water (watershed) reliability
- Installed pump capacity
- Intertie capacity (if used regularly to meet demands)
- Treatment capacity

We describe each of these source capacity-limiting factors below.

4.4.2.1 Water Rights

This section recognizes that water rights have a legal bearing on water system capacity determinations. Engineers **must** consider this limitation because water rights may limit the annual withdrawal (Q_a) and instantaneous withdrawal (Q_i) of water that a water system can legally withdraw from drinking water sources (WAC 246-290-110 and -130). Use ADD in assessing water right limitations associated with Q_a . Use MDD in assessing water right limitations associated with Q_i .

Although water rights place a regulatory/legal limit rather than a physical limit on the amount of water legally available for service, design engineers **must** address this important issue. Engineers **must** complete a [Water Rights Self-Assessment Form](#) for all new sources and projects that increase water system physical capacity or the approved number of connections (WAC 246-290-110(4)(e) and 130(4)(a)).

We do not have the authority to evaluate water right documents. Design engineers should contact the Department of Ecology about issues related to water rights before

submitting a capacity analysis to us. See contact information for Ecology's Water Resources Program in Appendix C.

4.4.2.2 Pumping Tests and Groundwater Reliability

A pumping test analysis determines the capacity of the well(s) to provide a reliable supply of the water needed to meet service demands. When evaluating well capacity, the design engineer should consider each of the following:

- Historical pumping records.
- Water quality issues.
- Pumping Test Procedures (Appendix E). If wells are close in proximity then it may be necessary to analyze the collective withdrawal capacity with multiple wells operating at once, to understand the level of interference between operating wells.
- Seawater Intrusion (Section 5.5.4).

Engineers **must** provide their analysis of pump-test results to us (WAC 246-290-130).

4.4.2.3 Surface Water (Watershed) Reliability

Design engineers **must** analyze the reliability of a new surface water supply as part of source approval (WAC 246-290-130(3)(c)). They often use hydrologic models for this purpose. The determined "safe yield" identifies the volume of water expected during critical dry periods. In planning for drinking water supplies, consider the safe yield as the 1-in-50 year or 1-in-100 year low flow, or a 98 or 99 percent level of annual water supply reliability (Prasifka 1988, Connecticut DPH 2006). Design engineers should define the expected inadequacy of supply during the return low-flow period, and address the expected water supply deficiency in a water shortage response plan. See Section 3.10.

A hydrologic assessment is an involved process described in more detail in several professional publications (AWWA 2007, Chow et al. 1988, Maidment 1993). In general, the safe yield analysis consists of many elements including:

- Developing a record of the spring or river flow. This usually requires multiple years of daily flow records.
- Diversions for other uses.
- Mandatory minimum flows for natural resource protection or other purposes.
- Available reservoir storage given other competing demands, such as flood control and hydroelectric power generation.
- Precipitation patterns.
- Evaporation and evapotranspiration rates.

Over time, changes in land use patterns, vegetation coverage, climate, and precipitation patterns may require a water system to reevaluate the safe yield to ensure a reliable and adequate water supply in the future. Water systems also **must** identify how to manage their customer demand as part of an overall water shortage response plan (WAC 246-290-100(4)(f); WAC 246-290-420).

4.4.2.4 Installed Pump Capacity

Unless we provide advanced approval to use finished water storage to meet MDD, source-pumping capacity **must** be sufficient to meet MDD (WAC 246-290-222(4)). Design engineers should consider each of the following when evaluating installed pump capacity:

- Metered source production and water system demand records.
- System head conditions when pumping to storage or distribution, and when pumping from wells with significant seasonal changes in dynamic (pumping) water levels.
- Pump curve(s).
- Pump controls and logic.
- An engineering analysis that verifies pump performance under actual system head conditions.

4.4.2.5 Interties

Nonemergency interties with neighboring approved water systems can provide additional source capacity for evaluating source-based service capacity. The engineer should evaluate each nonemergency intertie to determine its limitations. It is important to consider elements such as hydraulic limitations, water quality, and legal restrictions associated with water rights, or conditions on the purchase contract that define service restrictions. Section 5.9 provides further discussion and guidance on interties.

4.4.2.6 Treatment Capacity

A treatment capacity analysis determines whether any installed treatment processes limit the water system's source production capacity. When applying water treatment, such as filtration or blending to one or more sources, the net treatment plant production in combination with other untreated sources **must** be able to reliably supply at least the MDD while meeting all water quality performance requirements (WAC 246-290-222(5)).

Design engineers **must** translate nominal treatment plant capacity to net treatment plant capacity by deducting water volume and the time devoted to backwash and filter

to waste (filtration), and other required limitations on production necessary to maintain treatment efficacy (blending) (WAC 246-290-222(5)).

4.4.2.7 Determining ERUs based on Source Capacity

The engineer needs to evaluate the capacity of each individual source a water system uses. The overall water system source-capacity is the sum of the reliable production capability from each source, excluding emergency sources.

The amount of water that any source may provide is the product of its delivery rate and the amount of time it is used for service.

Equation 4-1: Individual Source Capacity

$$V_j = (Q_j)(t_j)$$

Where:

- V_j** = Total volume for source "j" over a 24-hour period (excluding emergency sources)
- Q_j** = Delivery rate of source (gallons per unit time)
- t_j** = Time that source "j" delivered flow (Q_j) over a 24-hour period. We recommend assessing daily source capacity based on 20 hours of pumping per day (1,200 minutes per day). See Section 3.10.

Engineers should base the design flow-rate (Q_j) for each source on any limiting factor that might restrict the peak-flow rate during maximum demand periods (such as well, stream, or aquifer capacity; installed pumping capacity; intertie capacity; treatment limitations and net treatment production; and/ or legal limitations such as water right limits).

Engineers should base the time (t_j) for each individual source on the period it can be, or is, used over a 24-hour period during maximum demand periods. For example, a pump may be restricted to operate for only a designated amount of time each day, or a treatment plant may produce water for only certain periods each day.

To determine maximum source-production capacity, it is clear that pumping for the full 1,440 minutes a day will provide the highest estimate for water system capacity, expressed in ERUs. However, it may not be practical or advisable to operate source pumps continually for 24 hours, even during peak-demand periods. We recommend

assessing daily source capacity based on 20 hours (1,200 minutes) of pumping in a 24-hour period, to provide a factor of safety to the assessment.

When engineers know the specific delivery-rate and operation-time of delivery for each source, they can use Equation 4-2 to determine total source capacity (the total quantity of water available over a specified period from all sources except emergency sources).

Equation 4-2: Total Source Capacity

$$V_T = \sum(Q_j)(t_j) = \sum V_j$$

Where:

\sum = Summation

j = Individual source designation, excluding emergency sources

V_T = Total volume of water delivered from all nonemergency sources over a 24-hour period.

Engineers can use Equation 4-3 to determine ERUs based on source capacity, and Equations 4-4a and 4-4b to determine the service capacity based on water right limitations.

Equation 4-3: ERU capacity based on source capacity

$$N = \frac{V_T}{ERU_{MDD}}$$

Where:

N = Number of ERUs based on the ERU_{MDD} value

Equation 4-4a: ERU capacity based on water rights (Qi)

$$N = \frac{Q_i}{ERU_{MDD}/1440}$$

Where:

N = Number of ERUs based on the ERU_{MDD} value

Equation 4-4b: Water system capacity based on water rights (Qa)

$$N = \frac{Q_a}{[ERU_{ADD} \times 365]}$$

Where:

N = Number of ERUs based on the ERU_{ADD} value

Engineers may summarize their source capacity analysis information on Worksheet 4-1 (at the end of this chapter), or a similar form. Alternately, design engineers may estimate the average daily demand of each demand component separately (single-family residential, multifamily, commercial, and so forth) plus DSL.

4.4.3 Step 3: Capacity Based on Storage

The design engineer **must** consider each of the following storage elements when determining the total storage volume requirement (WAC 236-290-235), whether the element relates directly to system capacity or not:

- **Operational storage (OS).** Adequate OS is important for efficient and reliable operation of sources. The design engineer **must** identify and provide adequate OS (WAC 246-290-222), but OS is not directly related to system capacity.
- **Equalizing storage (ES).** ES volume is based on PHD demand requirements. See Equation 4-6. To calculate ES volume, multiply the differential between operational source capacity and PHD times 150 minutes (2.5 hours). ES relates directly to system capacity.
- **Standby storage (SB).** SB allows a water system to maintain adequate pressure in the event of a mechanical, electrical or water quality issue with a source of supply, pumping or treatment system. See Equation 4-7. Detailed recommendations are in Section 7.1.1.3. SB volume is based on consumer expectations. ES and SB storage design calculations are exclusive of one another. SB relates directly to system capacity.

- **Fire suppression storage (FSS), if applicable.** The local fire authority establishes FSS and fire-flow rate and duration, generally based on land use. Engineers can partially address FSS volume by developing multiple sources (or multiple pumps in a single source, if applicable. See Section 5.11.2); emergency interties (see Section 5.9.2) and back-up power generation (see Section 5.11.1); and “nesting” SB and FSS (see Section 7.1.1.4). FSS does not relate directly to system capacity.
- **Dead storage (DS).** DS is the volume of stored water not available to all consumers at the minimum design pressure (WAC 246-290-230(5) and (6)). DS does not relate directly to system capacity.

The water system design **must** satisfy the minimum storage requirements of WAC 246-290-235. Elements to consider when determining minimum storage requirements include:

- The number of sources.
- Source capacity.
- ERU_{ADD} , ERU_{MDD} , and peak-hourly demands.
- Local fire-suppression requirements.
- The level of service and manner used to achieve reliability requirements described in (WAC 246-290-420).
- Adequacy of storage in specific pressure zones.
- Power grid reliability.
- Pressure requirements in the distribution system.

4.4.3.1 ERUs Based on Equalizing Storage

Equalizing storage **must** be available when determined necessary based on available, or designed source pumping capacity (WAC 246-290-235(2)). Equation 4-5 is the result of combining Equation 3-1 with Equation 7-1, allowing a solution for needed ES given a number of ERUs (N value). Key concepts associated with the use of Equations 4-5 and 4-6:

- Applies to water systems with significant residential demand.
- N is the number of ERUs supplied by all sources. DSL has an associated number of ERUs (see examples in Section 3.12 and Worksheet 4-1). Therefore, N includes DSL. “N” is the number of connections only if there is no distribution system leakage and all connections are single-family homes.
- Check to be sure that ERU_{MDD} times “N” equals total maximum daily source production.
- The ERU value is ERU_{MDD} . It is not appropriate to apply the ERU_{ADD} value.

Equation 4-5:

$$ES = \left[\left(\frac{ERU_{MDD}}{1440} \right) [(C)(N) + F] + 18 - Q_s \right] (150)$$

- Where**
- C** = Coefficient associated with ranges of ERUs (see Section 3.4.2)
 - N** = Number of ERUs based on the ERU_{MDD} value
 - F** = Factor associated with ranges of ERUs (see Section 3.4.2)
 - Q_s** = Sum of all installed and active supply source capacities except emergency supply, in gpm.
 - ERU_{MDD}** = Maximum Day Demand per ERU (gallons per day)

Equation 4-5 is derived by combining these two equations:

Determine PHD (see Section 3.4.2)

$$PHD = (ERU_{MDD} / 1440) [(C)(N) + F] + 18$$

- Where**
- PHD** = Peak Hourly Demand, total system (gallons per minute)
 - C** = Coefficient Associated with Ranges of ERUs
 - N** = Number of ERUs based on the ERU_{MDD} value
 - F** = Factor Associated with Ranges of ERUs
 - ERU_{MDD}** = Maximum Day Demand per ERU (gallons per day)

Determine ES (see Section 7.1.1.2)

$$ES = (PHD - Q_s)(150 \text{ minutes})$$

Where:

- ES** = Equalizing storage component, in gallons
- PHD** = Peak hourly demand, in gpm
- Q_s** = Sum of all installed and active supply source capacities except emergency supply, in gpm.

If the calculated ES volume is greater than the available ES volume, then there is not sufficient ES for the number of ERUs.

Equation 4-6 allows design engineers to solve for the number of ERUs (N) that a given volume of ES can supply. This approach applies to the most common method for controlling reservoir level, known as a “call-on-demand” system, which calls on the source(s) at a preset reservoir level(s).

Restating Equation 4-5 to solve for N, one can solve for N given available ES:

Equation 4-6:

$$N = \frac{1}{C} \left[\frac{(1440)}{(ERU_{MDD})} \left(\frac{ES}{150} + Q_S - 18 \right) \right] - F$$

Procedure for solving for N based on available ES (using Equation 4-6):

1. Calculate available ES. *The water system **must** maintain a 30-psi pressure in the distribution system under PHD when ES is depleted* (WAC 246-290-230(5)).
2. Determine the ERU_{MDD} and Q_S .
3. Select the lowest N value calculated from among Equation 4-3 (source capacity) and Equation 4-4 (water rights).
4. From Table 3-1 select the appropriate values for both C and F for the N value determined in Step 3.
5. Use Equation 4-6 and solve for N.
6. If the resulting value of N lies outside the range associated with the C and F values selected in Step 4, repeat the calculation using Equation 4-6 by using a different set of values for C and F. Continue until the value for N lies within the range of ERUs associated with the values for C and F selected. After completing these iterative calculations, the final value for N equals ERUs that a given equalizing storage volume can supply.

4.4.3.2 ERUs Based on Standby Storage

Standby storage is a volume of finished water a water system reserves to maintain a certain level of service if one or more permanent or seasonal source of supply becomes partially or completely unavailable for use.

Water systems **must** provide standby storage in an amount necessary to maintain reliable water service (WAC 246-290-235(3) and WAC 246-290-420). We recommend SB volume equal to the MDD for the pressure zone(s) served (i.e., $T_d = 1$ day) and adjust SB volume based on redundant sources and other factors (see Section 7.1.1.3). To satisfy WAC 246-290-235 and -420, we recommend that water systems provide a minimum standby storage volume of 200 gpd per ERU regardless of such factors.

At times, design engineers may consider SB nested within FSS. See Chapter 7 for detail on recommended sizing of the SB storage component, particularly when a water system has multiple sources (or multiple pumps in a single source. See Section 5.11.2), an

emergency intertie (see Section 5.9.2), and/or back-up power generation (see Section 5.11.1).

Equation 4-7:

$$N = \frac{SB}{(SB_i)(t_d)}$$

Where:

- N** = Number of ERUs based on the ERU_{MDD} value
- SB** = Total volume of water in standby storage component (gallons). See Section 7.1.1.3.
- SB_i** = Selected volume of standby storage to meet water system-determined standard of reliability in gallons per day per ERU (number of ERUs based on the ERU_{MDD} value)
- t_d** = Number of days selected to meet water system-determined standard of reliability.

Manipulate Equation 4-7 to solve for SB when you design new or expand water systems and you know the number of ERUs (N).

Engineers may enter tabulated results for Equations 4-6 and 4-7 on Worksheet 4-1, or a similar form.

4.4.4 Step 4: Capacity Based on Distribution Facilities

Design engineers **must** use a hydraulic analysis when evaluating distribution system capacity (WAC 246-290-230(1)). In most cases, DOH will require a well-documented hydraulic model. For some small, simple systems, DOH may accept manual calculations. Chapter 6 discusses transmission and distribution system design in detail.

Design engineers typically evaluate distribution systems under two conditions:

- Peak hour demand (PHD) (WAC 246-290-230(5))
- Maximum day demand (MDD) plus fire flow, if applicable (WAC 246-290-230(6))

Use a hydraulic analysis to determine whether the size of distribution system components are adequate to provide residual pressure at the customer meter or property line according to the water system's adopted standards, or the following minimum residual pressures, whichever is greater:

- At least 30 psi for new water systems or additions to existing water systems under PHD conditions (WAC 246-290-230(5)).
- At the approved design pressure, but not less than 20 psi, under PHD for existing systems (WAC 246-290-420(2)).
- At least 20 psi under demands that include MDD and fire flow (WAC 246-290-230(6)).

4.4.4.1 ERUs Based on Maintaining Adequate Residual Pressure under PHD Conditions

A water system **must** be able to provide PHD and (if applicable) maximum day demand plus needed fire flow while maintaining compliance with certain minimum pressure requirements throughout the distribution system (WAC 246-290-230(5)).

Engineers determine distribution adequacy on a pressure zone basis. ***The physical capacity of the distribution system is based solely on the ability of the water system to deliver the PHD while maintaining 30 psi or the approved design pressure throughout the system.*** When physical capacity limitations exist within a specific part of the distribution system, and until a solution is in place, design engineers should:

- Identify and report hydraulic deficiencies in PHD capacity to the water system and local planning and building department.
- Prioritize capital improvements to address deficiencies in delivering PHD within a reasonable timeframe.
- Help the water system identify and document operational steps that mitigate hydraulic deficiencies, so that distribution system pressure will not be less than 20 psi at any service connection during PHD conditions.

4.4.4.2 Fire Flow Effects on Capacity

While design engineers usually size distribution system facilities to meet fire flow demands, the number of connections that a water system can serve is independent of fire flow demands. Therefore, inadequate fire flow capacity does not limit the number of approved ERUs or connections. It is up to the local fire authority to decide whether to restrict development based on fire flow capacity. As part of the design analysis, you should:

- Identify and report hydraulic deficiencies in fire flow capacity to the local fire authority, the water system, and local planning and building department. .
- Prioritize capital improvements to meet potential fire flow demands within a reasonable period, and coordinate these improvements with the local fire authority.

- Help the water system and local fire authority to prepare operational plans that reflect hydraulic deficiencies in providing fire flow.

You **must** design distribution systems so that at least 20 psi can be maintained throughout the distribution system under fire flow conditions during maximum day demand (WAC 246-290-230(6)).

4.4.5 Step 5: Factoring DSL into Capacity Analysis

Distribution system leakage (see Section 3.8) exerts as real a demand on sources, storage, and distribution systems as actual customers. Evaluating water system capacity without considering the productive and distributive requirements associated with DSL will overstate water system capacity.

There are several ways to apply DSL to a water system capacity analysis:

- Express DSL as a separate demand on the water system, and express DSL in terms of ERUs based on ERU_{MDD} (see Section 3.12 examples and Chapter 4 Attachment A). We recommend this option. ***It offers the advantage of making clear the number of ERUs unavailable to the water system because of DSL***, and so provides the basis to compare the cost and effort involved in increasing service capacity by (1) increasing infrastructure capacity; (2) decreasing consumer demands (ERU_{MDD} and ERU_{ADD}); and (3) reducing DSL.
- Spread out DSL equally among all customers on an ERU basis. Design engineers may take this approach if the existing system serves only (or almost only) full-time single-family homes. This approach inserts DSL into the derived ERU_{MDD} and ERU_{ADD} values.

4.4.6 Step 6: Determine Limiting Criteria and Water System Service Capacity in ERUs

Attachment A provides an example of determining system capacity for a mixed use, predominantly residential water system. The example presumes defined values for ERU_{ADD} , ERU_{MDD} , system-wide ADD and MDD, and PHD. Refer to Chapter 3 for guidance on determining water system demand values.

We recommend that design engineers summarize the element(s) that limit water system capacity as well as the capacity of each system element (e.g., source production, water rights, storage, pumping). This information would inform water system managers when and which water system element to address to maintain water system capacity in support of their growing communities.

Part 2: Capacity Analysis for Nonresidential Systems

Nonresidential water systems do not lend themselves to analysis using ERUs as a common measure of demand. We recommend that design engineers analyze nonresidential water systems by identifying the composite ADD, MDD, and PHD for each customer or customer class. Section 3.6 provides guidance on determining water demand for nonresidential systems.

4.5 Methodology to Determine Water System Capacity

The following steps represent an approach for determining a predominantly nonresidential water system's physical capacity. Engineers may propose another approach supported by system-specific information and engineering justification.

4.5.1 Step 1: Water Demands

Design engineers **must** estimate water demands (WAC 246-290-221). For systems serving different customer classes, you should create separate estimates for residential and nonresidential connections. For existing systems, design engineers should quantify MDD and ADD using actual water consumption records. In designing a new water system, water use from an analogous water system or the approach described in Appendix D may be used. Engineers should use Equation 3-1 to estimate PHD for the residential portion of demand. For the nonresidential PHD, refer to Sections 3.5.2, 3.6, and 3.6.2.

4.5.2 Step 2: Source Capacity

All water systems **must** have sufficient source capacity to meet MDD (WAC 246-290-222(4)). If total permanent and seasonal source capacity cannot satisfy total consumptive demands plus DSL, do not use the equations shown later in this chapter. In that case, the design engineer must perform an alternate analysis. Design engineers proposing to use storage to meet MDD should consult with the regional engineer on specific requirements before pursuing such a design.

In general, the total daily source capacity **must** be able to *reliably* provide sufficient water to meet the MDD for the water system (WAC 246-290-222(4)). If sources cannot meet or exceed PHD, then equalizing storage **must** be provided to meet diurnal demands that exceed source capacity (WAC 246-290-235(2)). See Chapter 7 for equalizing storage requirements. Sources also **must** meet minimum reliability requirements (WAC 246-290-420). See Chapter 5 for design guidance for sources.

Base total system source capacity on the capacity of permanent and seasonal sources (WAC 246-290-222). Design engineers **cannot** include emergency sources, including emergency interties, in the total source capacity calculations (WAC 246-290-222(3)).

Design engineers should document the approach they use to assess source-based service capacity into the physical capacity analysis and all related assumptions: data acquired to determine full- and part-time residential, nonresidential, and nonrevenue water demands; identifying DSL; and the source adequacy and reliability issues described in Section 3.10.

Design engineers should refer to the following information to determine source capacity. The most limiting element establishes the source-based service capacity.

- Water rights
- Pumping tests and groundwater reliability
- Surface water (watershed) reliability
- Installed pump capacity
- Intertie capacity (if used regularly to meet demands)
- Treatment capacity

We describe each of these source capacity-limiting factors below.

4.5.2.1 Water Rights

This section recognizes that water rights have a legal bearing on water system capacity determinations. Engineers must consider this limitation because water rights may limit the legal annual withdrawal (Q_a) and instantaneous withdrawal (Q_i) a water system can make from drinking water sources. Use ADD in assessing water right limitations associated with Q_a . Use MDD in assessing water right limitations associated with Q_i .

Although water rights place a regulatory/legal limit rather than a physical limit on the amount of water legally available for service, design engineers **must** address this important issue. Engineers **must** complete a [Water Rights Self-Assessment Form](#) for all new sources and projects that increase water system physical capacity or the approved number of connections (WAC 246-290-110(4)(e) and 130(4)(a)).

We do not have the authority to evaluate water right documents. Design engineers should contact the Department of Ecology about issues related to water rights before submitting a capacity analysis to us.

4.5.2.2 Pumping Tests and Groundwater Reliability

A pumping test analysis determines the capacity of the well(s) to reliably supply the water needed to meet service demands. When evaluating well capacity, the design engineer should consider each of the following:

- Historical pumping records.
- Water quality issues.
- Pumping Test Procedures (Appendix E). If wells are close in proximity then it may be necessary to analyze the collective withdrawal capacity with multiple wells operating at once, to understand the level of interference between operating wells
- Seawater Intrusion (Section 5.5.4)

Engineers **must** provide their analysis of pump-test results to us (WAC 246-290-130).

4.5.2.3 Surface Water (Watershed) Reliability

Design engineers **must** analyze the reliability of a new surface water supply as part of source approval (WAC 246-290-130(3)(c)). They often use hydrologic models for this purpose. The determined "safe yield" identifies the volume of water expected during critical dry periods. In planning for drinking water supplies, the safe yield is the 1-in-50 year or 1-in-100 year low flow, or a 98 or 99 percent level of annual water supply reliability (Prasifka 1988, Connecticut DPH 2006). Design engineers should define the expected inadequacy of supply during the return low-flow period, and address the expected water supply deficiency in a water shortage response plan. See Section 3.10.2.

A hydrologic assessment is an involved process described in more detail in several professional publications (AWWA 2007, Chow et al. 1988, Maidment 1992). In general, the safe yield analysis consists of many elements, including:

- A record of the spring or river flow. Multiple years of daily flow records are usually necessary.
- Diversions for other uses.
- Mandatory minimum flows for natural resource protection or other purposes.
- Reservoir storage that can be used given other competing demands such as flood control and hydroelectric power generation.
- Precipitation patterns.
- Evaporation and evapotranspiration rates.

Over time, changes in land use patterns, vegetation coverage, climate, and precipitation patterns may necessitate the reevaluation of the safe yield to ensure a reliable and adequate water supply in the future. Water systems **must** also identify how to manage their customer demand as part of an overall water shortage response plan (WAC 246-290-100(4)(f); WAC 246-290-420).

4.5.2.4 Installed Pump Capacity

Unless we provide advanced approval to use finished water storage to meet MDD, source-pumping capacity **must** be sufficient to meet MDD. Design engineers should consider each of the following when evaluating installed pump capacity:

- Metered source production and water system demand records.
- System head conditions when pumping to storage or distribution, and when pumping from wells with significant seasonal changes in dynamic (pumping) water levels.
- Pump curve(s).
- Pump controls and logic.
- An engineering analysis that verifies pump performance under actual system head conditions.

4.5.2.5 Interties

Nonemergency interties with neighboring approved water systems can provide additional source capacity for evaluating source-based service capacity. The engineer should evaluate each nonemergency intertie to determine its limitations. It is important to consider elements such as hydraulic limitations, water quality, and legal restrictions associated with water rights, or conditions on the purchase contract that define service restrictions. Section 5.9 provides further discussion and guidance on interties.

4.5.2.6 Treatment Capacity

A treatment capacity analysis determines whether any installed treatment processes limit the water system's source production capacity. When applying water treatment such as filtration or blending to one or more sources, the net treatment plant production in combination with other untreated sources **must** be able to reliably supply at least the MDD while meeting all water quality performance requirements (WAC 246-290-222(5)).

Design engineers **must** translate nominal treatment plant capacity to net treatment plant capacity by deducting water volume and the time devoted to backwash and filter

to waste (filtration), and other required limitations on production necessary to maintain treatment efficacy (blending) (WAC 246-290-222(5)).

4.5.2.7 Determining Capacity based on Source of Supply

The engineer needs to evaluate the capacity of each individual source a water system uses. The overall water system source-capacity is the sum of the reliable production capability from each source, excluding emergency sources.

The amount of water that any source may provide is the product of its delivery rate and the amount of time it is used for service.

Equation 4-1: Individual Source Capacity

$$V_j = (Q_j)(t_j)$$

Where:

- V_j** = Total volume for source "j" over a 24-hour period (excluding emergency sources)
- Q_j** = Delivery rate of source (gallons per unit time)
- t_j** = Time that source "j" delivered flow (Q_j) over a 24-hour period. We recommend assessing daily source capacity based on 20 hours of pumping per day (1,200 minutes per day). See Section 3.10.

Engineers should base the design flow-rate (Q_j) for each source on any limiting factor that might restrict the peak-flow rate during maximum demand periods (such as well, stream, or aquifer capacity; installed pumping capacity; intertie capacity; treatment limitations and net treatment production; and legal limitations such as water right limits).

Engineers should base the time (t_j) for each individual source on the period it can be, or is, used over a 24-hour period during maximum demand periods. For example, a pump may be restricted to operate for only a designated amount of time each day, or a treatment plant may produce water for only certain periods each day.

To determine maximum source-production capacity, it is clear that pumping for the full 1,440 minutes a day will provide the highest estimate for water system capacity. However, it may not be practical or advisable to operate source pumps continually for 24 hours, even during peak-demand periods. We recommend assessing daily source

capacity based on 20 hours (1,200 minutes) of pumping in a 24-hour period, to provide a factor of safety to the assessment.

When engineers know the specific delivery-rate and operation-time of delivery for each source, they can use Equation 4-2 to determine total source capacity (the total quantity of water available over a specified time period from all sources except emergency sources).

Equation 4-2: Total Source Capacity

$$V_T = \sum(Q_j)(t_j) = \sum V_j$$

Where:

\sum = Summation

j = Individual source designation, excluding emergency sources

V_T = Total volume of water delivered from all nonemergency sources over a 24-hour period.

4.5.3 Step 3: Capacity Based on Storage

The design engineer **must** consider each of the following storage elements when determining the total storage volume requirement (WAC 236-290-235), even when the element does not relate directly to system capacity:

- **Operational storage (OS).** Adequate OS is important for efficient and reliable operation of sources. The design engineer **must** identify and provide adequate OS (WAC 246-290-222), but OS is not directly related to system capacity.
- **Equalizing storage (ES).** ES volume is based on PHD demand requirements. See Equation 4-6. To calculate ES volume, multiply the differential between operational source capacity and PHD times 150 minutes (2.5 hours). ES relates directly to system capacity.
- **Standby storage (SB).** SB allows a water system to maintain adequate pressure in the event of a mechanical, electrical or water quality issue with a source of supply, pumping, or treatment system. See Equation 4-7. Detailed recommendations are in Section 7.1.1.3. SB volume is based on consumer expectations. ES and SB storage design calculations are exclusive of one another. SB relates directly to system capacity.
- **Fire suppression storage (FSS), if applicable.** The local fire authority establishes FSS and fire flow rate and duration, generally based on land use. Engineers can partially address FSS volume by developing multiple sources (or multiple pumps in a single source, if applicable; see Section 5.11.2); emergency interties (see

Section 5.9.2), and back-up power generation (see Section 5.11.1); and “nesting” SB and FSS (see Section 7.1.1.4). FSS does not relate directly to system capacity.

- **Dead storage (DS).** DS is the volume of stored water not available to all consumers at the minimum design pressure (WAC 246-290-230(5) and (6)). DS does not relate directly to system capacity.

The water system design **must** satisfy the minimum storage requirements of WAC 246-290-235. Elements that define minimum storage requirements include:

- The number of sources.
- Source capacity.
- MDD, ADD, and PHD.
- Local fire-suppression requirements.
- The level of service and manner used to achieve reliability requirements described in WAC 246-290-420.
- Adequacy of storage in specific pressure zones.
- Power grid reliability.
- Pressure requirements in the distribution system.

4.5.3.1 Equalizing Storage

Equalizing storage **must** be available when determined necessary based on available, or designed, source pumping capacity (WAC 246-290-235(2)).

4.5.3.2 Standby Storage

Standby storage is a volume of finished water a water system reserves to maintain a certain level of service if one or more permanent or seasonal source of supply becomes partially or completely unavailable for use. See Section 7.1.1.3 for recommendations on SB for some types of nonresidential water systems.

4.5.4 Step 4: Capacity Based on Distribution Facilities

Design engineers **must** use a hydraulic analysis when evaluating distribution system capacity (WAC 246-290-230(1)). In most cases, DOH will require a well-documented hydraulic model. We may accept manual calculations for some small, simple systems. Chapter 6 discusses transmission and distribution system design in detail.

Design engineers typically evaluate distribution systems under two conditions:

- Peak hour demand (PHD) (WAC 246-290-230(5))
- Maximum day demand (MDD) plus fire flow, if applicable (WAC 246-290-230(6))

Use a hydraulic analysis to determine whether the size of distribution system components can adequately provide residual pressure at the customer meter or property line according to the water system's adopted standards, or the following minimum residual pressures, whichever is greater:

- At least 30 psi for new water systems or additions to existing water systems under PHD conditions (WAC 246-290-230(5))
- At the approved design pressure, but not less than 20 psi, under PHD for existing systems (WAC 246-290-420(2))
- At least 20 psi under demands that include MDD and fire flow (WAC 246-290-230(6)).

4.5.4.1 PHD Conditions

A water system **must** be able to provide PHD and (if applicable) maximum day demand plus needed fire flow while maintaining compliance with certain minimum pressure requirements throughout the distribution system (WAC 246-290-230(5)).

Engineers determine distribution adequacy on a pressure zone basis. ***The physical capacity of the distribution system is based solely on the ability of the water system to deliver the PHD while maintaining 30 psi or the approved design pressure throughout the system.*** When physical capacity limitations exist within a specific part of the distribution system, and until a solution is in place, design engineers should:

- Identify and report hydraulic deficiencies in PHD capacity to the water system and local planning and building department.
- Prioritize capital improvements to address deficiencies in delivering PHD within a reasonable timeframe.
- Help the water system identify and document operational steps that mitigate hydraulic deficiencies, so that distribution system pressure will not be less than 20 psi at any service connection during PHD conditions.

4.5.4.2 Fire Flow Conditions

Design engineers **must** consider fire conditions, if applicable (WAC 246-290-230). The local fire authority decides whether to restrict development based on fire flow capacity. As part of the design analysis, you should:

- Identify and report hydraulic deficiencies in fire flow capacity to the local fire authority, the water system, and local planning and building department.

- Prioritize capital improvements to meet potential fire flow demands within a reasonable period, and coordinate these improvements with the local fire authority.
- Help the water system and local fire authority to prepare operational plans that reflect hydraulic deficiencies in providing fire flow.

You **must** design the distribution system so that at least 20 psi can be maintained throughout the distribution system under fire flow conditions during maximum day demand (WAC 246-290-230(6)).

4.5.5 Step 5: Factoring DSL into Capacity Analysis

Distribution system leakage (see Section 3.8) exerts as real a demand on sources, storage, and distribution systems as actual customers. Evaluating water system capacity without considering the productive and distributive requirements associated with DSL will overstate water system capacity. Engineers **must** include DSL when estimating system-wide ADD and MDD (WAC 246-290-820).

4.6 Documenting Nonresidential Water System Capacity

The capacity of nonresidential systems should reflect existing customer demands and assumptions about future customers and their demand pattern. Express capacity as the nonresidential system's ability to supply MDD and PHD reliably to a specific set of existing or planned buildings and population. We will hold the nonresidential water system owner accountable for operating within the approved capacity of the system as documented in the approved design documents.

4.7 Examples of Nonresidential Water System Capacity Analysis

The following examples illustrate the concepts presented in this chapter. They do not represent a recipe for completing a capacity assessment of a new, expanding, or existing nonexpanding nonresidential water system.

Example 1: Port District (expanding)

Given:

A port district owns an existing water system that serves one industrial and four commercial customers. DOH approved the system is to serve five nonresidential connections. Currently, we consider this system “built-out.”

A single deep well turbine pump supplies the system. The total source capacity is 6.0 MGD, based on 20 hours of pumping and a pumping capacity of 5,000 gpm. A variable frequency drive modulates flow from the deep well turbine pump to match system demand. The port’s water right allows groundwater withdrawal of 5,000 gpm and 4,500 ac-ft. per year. The system has no storage and no treatment. Distribution system piping is looped 12- and 16-inch ductile iron pipe. The system supplies one industrial connection and four commercial connections. See water demand information below:

User	ADD	MDD	PHD	Source of information
All	2.3	3.8	4,100	ADD and MDD taken from source meter readings. Therefore, it includes DSL. Includes factor of safety.
Industrial	1.7	3.0	3,500	PHD based on information taken from a data logger installed at the industrial connection service meter. Includes factor of safety.
All Commercial	0.4	0.6	450	PHD estimated. Includes a factor of safety.
Implied DSL	0.2	0.2	150	DSL estimated.

The port district receives notice from the industrial customer. Proposed process changes will increase the facility’s ADD by 0.2 MGD, MDD by 0.5 MGD, and PHD by 500 gpm. The port agrees to amend its contract with the industrial customer.

At the same time, the port commissioners decide to subdivide unused port land to increase the number of customers. The port is willing to construct storage to improve reliability and provide fire suppression, but it is not willing to construct a new source of supply. The district’s budget for water system improvements is \$2.5 million. The undeveloped land may support a maximum of 10 industrial and commercial building sites.

The district intends to market the new industrial and commercial sites based on the availability of “an abundant water supply.” The commissioners want to maximize the number of new sites, and to promise prospective leasees a minimum MDD and PHD for each new site in keeping with the “abundance” marketing theme.

The local fire marshal determined fire flow requirements are 3,000 gpm for 3 hours, and that fire suppression storage may be nested with standby storage.

Find:

The number of sites the port can develop and the volume/flow of water should be marketed and reserved for each new site.

Solution:

1. Revised ADD, MDD, and PHD of existing system after industrial customer changes:
 - a. System ADD = $2.3 + 0.2 = 2.5$ MGD
 - b. System MDD = $3.8 + 0.5 = 4.3$ MGD
 - c. System PHD = $3,500 + 450 + 150 + 500 = 4,600$ gpm
2. Remaining available water rights, ADD, and MDD:
 - a. $5,000 - 4,600 = 400$ gpm (Qi)
 - b. $[4,500 \text{ af/yr.} \times 326,000 \text{ gallons per af}] - 2.5 \text{ MGD} \times 365 = 555 \text{ MG per year (Qa)}$
 - c. Remaining available ADD: $555 \text{ MG} \div 365 = 1.5 \text{ MGD}$
 - d. Remaining available MDD (20 hours pumping): $6.0 - 4.3 = 1.7 \text{ MGD}$
 - e. Remaining available MDD (24 hours pumping): $7.2 - 4.3 = 3.9 \text{ MGD}$
3. Preliminary design and engineering cost estimate indicate a 1.0 MG elevated reservoir is the maximum size an engineer can design and construct for less than \$2.5 million.
4. The following table explores options for new building site use and water supply allocation based on proposed commercial and industrial water supply contracts:

Option	Commercial			Industrial			Total		
	ADD	MDD	PHD	ADD	MDD	PHD	ADD	MDD	PHD
10 Commercial sites	1.0	1.5	1,000	0	0	0	1.0	1.5	1,000
1 Industrial & 8 Comm	0.8	1.2	800	0.7	1.2	2,000	1.5	2.4	2,800
2 Industrial & 3 Comm	0.3	0.45	300	1.4	2.4	4,000	1.7	2.9	4,300

5. Operational storage requirements are minimal, given the variable frequency drive on the source pump. Allocate 0.05 MG to OS. The remaining storage is available for equalizing, standby, and fire suppression storage.
6. The following table summarizes the capacity evaluation for each option:

Option	Source Capacity	Water Right	Storage
10 Commercial sites	Adequate to supply MDD	Qa and Qi adequate	OS = 0.05 MG Fire flow = 0.54 MG ES = [(4,600 + 1,000) – 5,000] x 150 = 0.09 MG SB = Not promised in service contracts Storage needed: 0.68 MG
1 Industrial & 8 Comm	Adequate to supply MDD if pumped 22+ hours per day	Qa and Qi adequate	OS = 0.05 MG Fire flow = 0.54 MG ES = [(4,600 + 2,800) – 5,000] x 150 = 0.36 MG SB = Not promised in service contracts Storage needed: 0.95 MG
2 Industrial & 3 Comm	Adequate to supply MDD if pumped 24 hours per day	Qa and Qi adequate	OS = 0.05 MG Fire flow = 0.54 MG ES = [(4,600 + 4,300) – 5,000] x 150 = 0.58 MG SB = Not promised in service contracts Storage needed: 1.18 MG

7. For each option, the existing 12- and 16-inch looped distribution system is not a limiting factor. Hydraulic modeling indicates: (1) At the bottom of ES during PHD, pressure at all points along the distribution system should be greater than 30 psi; (2) At the bottom of fire suppression storage during MDD plus needed fire flow, pressure at all points along the distribution system should be greater than 20 psi.

8. Conclusions: The port commissioners may:
- a. Select the first option (10 new commercial connections), which leaves a supply and storage cushion if customers exceed their allotted MDD and PHD water supply.
 - b. Select the second option (1 new industrial and 8 new commercial connections), but this leaves no supply or storage cushion, and assumes a 22+-hour per day pumping duty to meet MDD.
 - c. Not select the third option (2 industrial and 3 commercial connections) without changing the assumptions about contracted MDD and PHD for each customer, or increasing the budget to construct a larger reservoir.
9. To illustrate, assume the port selects the second option. In that case, our approval letter will specifically reference the following information:
- a. Approved for 14 nonresidential connections.
 - b. The port district needs to operate within the approved design parameters.

Example 2 – Youth Camp (expanding and increasing use)

Given:

An existing youth camp supplied by:

- A single well producing 18 gpm with greensand filtration for iron/manganese removal that is 90 percent efficient.
- A 20,000-gallon ground level storage tank.
- A booster pump station consisting of two 40-gpm pumps that can in parallel deliver about 70 gpm to the distribution system. Under peak demand, the pumps and distribution system can deliver only at 25 psi at the recreation center (north end of system) and camp director's home (south end of system).

The camp water system:

- Originally approved in 1969 for 15 cabins and the dining hall, based on providing 20 psi during PHD. There have been no approvals since 1969.
- Currently has a "Blue" operating permit, since it is operating outside its design approval.
- Consists of 2- and 3-inch PVC water mains and no service meters.
- Is not required to provide fire suppression (per the local fire authority).
- Serves a dining hall, recreation center, lakeside bathhouse, individual homes for the camp director and the chief maintenance superintendent, common toilet and shower building, and 34 primitive cabins without water service, for a total of 40 structures.
- Irrigates a ball field.

The camp:

- Has a local permit approving maximum occupancy of 220 persons.
- Operates from late May until early September.
- Holds a water right for 4 ac ft. per year (Qa) and 20 gpm (Qi).

Existing water system demand information:

- Estimated MDD is 15,000 gpd, including DSL and a factor of safety, based on the last 3 years of source production information.
- Estimated PHD is 40-50 gpm.
- Annual source production is 0.75 MG, including a factor of safety, based on the last 3 years of source production information.

Find:

The board of directors want to expand the period of operation, from early April until late October, to cater to other visitor groups on weekends during non-summer months. The camp also wants to increase the approved occupancy to 300, to include campers, administrators, and camp counselors.

Determine whether the existing water system has the capacity to support the directors' vision and, if not, identify the improvements needed to do so.

Solution:

1. Source treatment capacity is $18 \text{ gpm} \times 20 \text{ hours per day} \times 0.9 = 19,000 \text{ gpd}$
2. Remaining available water rights, MDD, and PHD:
 - a. Remaining available Q_a : $[4 \text{ af} \times 326,000 \text{ gallons per af}] - 0.75 \text{ MG} = 0.55 \text{ MG}$
 - b. Remaining available Q_i : $20 \text{ gpm} - 18 \text{ gpm} = 2 \text{ gpm}$
 - c. Remaining available MDD: $19,000 - 15,000 = 4,000 \text{ gpd}$
 - d. Remaining available PHD: $70 \text{ gpm} - 50 \text{ gpm} = 20 \text{ gpm}$
3. Each additional overnight camper or counselor: 50 gpd per camper (Table 3.2)
4. $4,000 \text{ gpd excess MDD} \div 50 \text{ gpd per camper} = 80 \text{ new campers}$
5. 80 new campers will require construction of 10 new rustic cabins, conversion of the recreation center into a dual use dining and recreation facility, and construction of a second toilet and shower building, comprising a total 40 (existing) + 10 + 1 = 51 structures – 49 nonresidential and 2 residential.
6. PHD estimated at $(19,000 \div 1,440) \times 4.5 = 59 \text{ gpm}$ (eq. 3-2). Use 60 gpm.
 - a. Existing booster pump capacity (in gpm) is considered sufficient
7. Storage analysis of expanded systems:
 - a. OS = 20 minutes of source off to allow for filter backwash and well pump "off" cycle for pump protection = $20 \text{ minutes} \times 60 \text{ gpm} = 1,200 \text{ gallons}$
 - b. ES required = $[60 \text{ gpm} - (18 \times 0.9)] \times 150 = 6,600 \text{ gallons}$
 - c. DS = 12 inches of tank bottom = 2,000 gallons
 - d. Remaining SB available: $20,000 - 1,200 - 6,600 - 2,000 = 10,200 \text{ gallons}$. This provides for 35 gallons per camp occupant if the well pump or treatment process is removed temporarily from of service.
8. Annual withdrawal will increase by:
 - a. $80 \text{ additional summer occupants} \times [(50 \text{ gpd per occupant}) \div 0.9] \times 100 \text{ days} = 0.44 \text{ MG}$

- b. $0.55 - 0.44 = 0.11$ MG remains available for group weekend retreats in the spring and fall. Assume 16 weekends annually = 35 days per year total.
 - c. $110,000 \text{ gallons} = X \text{ occupants} \times [(50 \text{ gpd per occupant}) \div 0.9] \times 35 \text{ days}$; $X = 60$ occupants, or about 1 to 2 occupants per cabin.
9. The camp must replace the two booster pumps to deliver a PHD of at least 60 gpm and maintain at least 30 psi throughout the distribution system.
10. Our approval letter will specifically reference:
- a. Approval to serve 49 nonresidential and 2 residential structures, with a maximum occupancy of 300 persons
 - b. The camp must operate within the approved design parameters: Not to exceed 300 occupants during the summer camping season; not to exceed 50 occupants during the spring and fall; and manage supply requirements so it does not exceed 19,000 gpd during any time of year.

Example 3 – Concert and Catering Venue (expanding and increasing use)

Given:

A winery with a food service permit. The winery gets potable water from:

- A permit-exempt well with a rated capacity of 15 gpm at 100 ft total dynamic head (no water right and no source meter).
- A 5,000-gallon ground level storage tank.
- A variable frequency drive booster pump with a rated maximum capacity of 40 gpm at 30 psi (no meter on booster pump).

The winery's potable water system supplies:

- A single-family home.
- A combined retail sales building and tasting room with approved occupancy up to 40 people.
- Three production buildings with drinking fountains and wash sinks for 8 employees.
- Picnic area (irrigated by nonpotable irrigation system) with restroom, covered seating, and food-prep sink facilities for up to 20 guests.
- A total of 6 nonresidential connections and 1 residential connection.

Existing water system demand information:

- No measured production or consumption data available.

- Estimating MDD: Including the single-family home, sales and tasting room based on maximum occupancy and two groups per day, employees, the picnic area restroom, and food prep results in an estimated MDD = 2,000 gpd. See Table 3.2.

The winery owner seeks to expand operations by developing an outdoor concert venue, a full-service RV park, and expanding food preparation from only prepackaged items to include hot and cold hors d'oeuvres.

Find:

- The number of RV sites the system can develop.
- The total occupancy the existing water system facilities accommodate at the new concert venue.

Solution:

1. Remaining available maximum daily well withdrawal: $5,000 - 2,000 = 3,000$ gallons
2. Using the fixture method, current PHD is estimated at 24 gpm
3. Remaining booster pumping capacity = $40 - 24 = 16$ gpm
4. Storage analysis:
 - a. OS is minimal. Use 400 gallons.
 - b. DS is bottom 9 inches of reservoir = 600 gallons
 - c. Remaining volume (4,000 gallons) allocated to ES. Maximum PHD supported by 4,000 gallons of ES. $ES = 4,000 = (PHD - 15) \times 150$. $PHD = 41$ gpm.
 - d. The owner decides no SB is necessary. The winery and concert venue will shut down if the well or booster pump fails.
5. Demand of proposed new uses:
 - a. Assume each RV site consumes 140 gpd.
 - b. Assume each concert goer/food patron consumes 10 gpd.
6. Remaining MDD = $3,000 = (RV \times 140) + (Patron \times 10)$. Possible solutions:
 - a. 10 RVs and 150 patrons
 - b. 15 RVs and 90 patrons
7. PHD, assuming the owner selects 10 RV sites and up to 160 additional patrons for concerts.
 - a. Using Figure 3.1, Equation 3.2, and Table 3.2, the PHD for the 10 RV sites is estimated at 15 gpm. Total PHD = $24 + 15 = 39$ gpm

8. Continue to assume the owner selects the first option. In that case, our approval letter will specifically reference the following:
 - a. Approved for 16 nonresidential connections and 1 residential connection, with a maximum occupancy of 200 visitors at any time.
 - b. The winery owner must operate within the approved design parameters: Not to exceed 200 visitors (total) at any time; and manage supply requirements so it does not exceed 5,000 gpd (total).

References

AWWA. 2007. *Water Resources Planning. Chapter 8: Hydrologic Modeling*, 2nd Edition.

Connecticut Department of Public Health. 2006. *Source Water Protection Measures*. Title 25, Section 25-32d. Connecticut DPH. Hartford, CT.

Chow, V.T., Maidment, D. R., & Mays, L. W. 1988. *Applied Hydrology*. McGraw Hill, Inc. New York, NY.

Maidment, D. R. 1992. *Handbook of Hydrology*. McGraw-Hill, Inc. New York, NY.

Prasifka, D.W. 1988. *Current Trends in Water Supply Planning: Issues, Concepts, and Risks*. Van Nostrand Reinhold Company, Inc. New York, NY.

WORKSHEET 4-1 ERU Capacity Summary

Specific Single-Family Residential Connection Criteria (measured or estimated demands)

Average Day Demand (ADD): _____ gpd/ERU

Maximum Day Demand (MDD) _____ gpd/ERU

Water System Connections Correlated to ERUs			
Service Classification	Total MDD for the classification, gpd	Total # Connections in the classification	ERUs
Residential			
Single-family			
Multifamily			
Nonresidential			
Industrial			
Commercial			
Governmental			
Agricultural			
Recreational			
Other (specify)			
DSL		N/A	
Other (identify)			
Total existing ERUs (Residential + Nonresidential + DSL + Other) =			_____

Service Capacity as ERUs and Gallons Per Day		
Water System Component (Facility)	ERU Capacity for Each Component	GPD Capacity for Each Component
Source(s)		
Treatment		
Equalizing Storage		
Standby Storage		
Transmission		
Water Rights (Qa and Qi)		
Other (specify)		
Water System Service Capacity (ERUs) =		
(based on the limiting water system component shown above)		

Notes:

- Capacity determinations are only for existing facilities that are operational for the water system.
- Not shown above are distribution system limitations (Section 4.5.4) on ERUs because these are location-specific within the distribution system. These limits not expected to limit the ERU capacity of the entire water system.

Attachment A: Documenting Capacity Evaluation (Example)

This example shows how to document the results of a water system’s service capacity evaluation. See Section 3.12 for examples that show how to derive these values.

Average Day Demand ERU_{ADD} 425 gpd/ERU
 Maximum Day Demand ERU_{MDD} 725 gpd/ERU

Water System Connections Correlated to ERUs			
Service Classification	Total for the classification, gpd	Total # Connections in the classification	ERUs
Residential			
Single-family	101,000 (MDD)	139	139
Multifamily	5,000 (MDD)	10	7
Nonresidential			
Industrial	150,000 (MDD)	1	207
Commercial	20,000 (MDD)	3	28
Governmental	10,000 (MDD)	1	14
Agricultural	N/A	N/A	
Recreational	5,000 (MDD)	2	7
Other (specify)	N/A		
DSL	35,000 gpd	N/A	48
Totals	326,000 gpd	156 connections	450 ERUs

Service Capacity as ERUs and Gallons Per Day		
Water System Component (Facility)	ERU Capacity for Each Component	Gallons/GPD Capacity for Each Component
Source(s)	496	360,000 gpd
Treatment	No treatment provided	No treatment provided
Equalizing Storage	501	53,000 gallons
Standby Storage	600 Local standard = 300 gal/ERU	180,000 gallons
Transmission	>600	Determined ample
Water Rights (Qa and Qi)	705 for Qa 496 for Qi	330 ac-ft. per year (0.3 MGD) 250 gpm (0.36 MGD)
Water System Service Capacity (ERUs) = 496 (based on the limiting water system component shown above)		

In this example, the water system demonstrates an excess capacity of 46 ERUs (496 – 450 = 46). We assume each future connection will use water consistent with an ERU. The example assumes that the addition of new connections will not result in an increase in the system’s current DSL (i.e., build-out rather than expansion of the distribution system).

Following these two assumptions, we will translate and record the reported capacity as an approved number of connections, consistent with WAC 246-290-222.

Using the above example, we would record capacity information on the water system’s WFI as shown in the table below. The “DOH Calc” service connection total (bottom line) includes single-family residential connections, multifamily residential units, recreational service connections, and other types of connections. Total service connections do not include the multifamily buildings themselves (the calculation includes only each dwelling unit within such buildings).

The excess service capacity is reflected as the difference of the two numbers on the “total service connection” line (156 + 46 = 202).

Service Category	Current System Est.	DOH Calc.	DOH Approved
Total Residential Connections	0	149	202
Full-time Single-family Residences (Occupied >= 180 Days a Year)	139		
Part-time Single-family Residences (Occupied < 180 Days a Year)	0		
Multifamily Residential Buildings (Apartments, Condos, Barracks, Dorms, etc.)	1		
Full-time Residential Units (Occupied >= 180 Days a Year)	10		
Part-time Residential Units (Occupied < 180 Days a Year)	0		
Recreational Services and/or Transient Accommodations	2	2	0
Other Nonresidential Services (Institutional, Industrial, Commercial, or Agricultural)	5	5	0
Total Service Connections		156	202

Our approval letter will include a statement such as:

We based the number of approved connections on an assumption that each future connection will use water consistent with an average single-family residence your water system supplies. Other types of new connections, such as apartments, businesses, or parks may use more or less water than an average single-family residence.

You must permit additional new connections in a manner that recognizes all new connections added and the water demands associated with each new connection. Your process must ensure an accurate assessment of the remaining service capacity available,

expressed as ERUs, so your system does not exceed physical capacity and water right limitations.

Our approval of your (water system plan or project report) does not confer or guarantee any right to a specific quantity of water. We based the approved number of service connections on your representation of available water quantity. If the Department of Ecology, a local planning agency, or other authority responsible for determining water rights and water system adequacy determines that you have use of less water than you represented, we may reduce the number of approved connections commensurate with the actual amount of water and your legal right to use it.

Chapter 5: Source of Supply

5.0 Introduction

Safe and reliable drinking water begins with the source of supply. Each public water system has an obligation to secure drinking water from the highest quality source feasible (WAC 246-290-130(1)) with sufficient capacity to meet customer demands (WAC 246-290-222(4) and WAC 246-290-420). Meeting this obligation is challenging given our state's limited water resources and the variety of potential contaminant sources in our environment.

Water resources in Washington present a significant challenge to drinking water systems seeking to develop new or expanding supplies. We urge design engineers to consult with Ecology before investing significant time and resources into water supply planning and design. Some water right limitations may preclude the development of a new drinking water source. See Section 5.12 for guidance on water resource issues related to new or expanding sources of supply.

Our natural and man-made environments pose significant risks of source water contamination. Technology makes it possible to provide treatment to virtually any water source and produce high quality drinking water. However, we believe complex technology in ill-equipped hands creates an unacceptable level of public health risk. When evaluating a new source of supply—especially one that needs treatment—design engineers should consider the long-term technical, managerial, and financial capacity of the water system to maintain and operate the facility to protect the health of their customers.

This chapter offers guidance on evaluating different drinking water supplies and presents topics that design engineers must consider when designing a new or modified drinking water source.

5.1 Drinking Water Contaminants

All sources used as a public drinking water supply **must** meet water quality standards, known as maximum contaminant levels (MCLs), set by EPA or the state (WAC 246-290-310). If despite a thorough alternatives analysis the selected source water requires treatment, then the source design **must** include the appropriate treatment needed to reliably meet applicable water quality standards (WAC 246-290-130(5), 250, and Part 6). See Chapter 10 for guidance on treatment plant design.

Primary drinking water contaminants can affect human health. Acute contaminants such as viruses, *E. coli*, *Giardia*, *Cryptosporidium* (microbial), and nitrate and nitrite (chemical) may cause illness with short-term exposure. Depending on the concentration, longer-term exposure to organic and most inorganic contaminants, and radionuclides may cause illness. Each regulated chemical and radiological contaminant has a drinking water MCL. Microbial drinking water contaminants have an assigned drinking water treatment technique requirement (disinfection or disinfection and filtration) instead of a MCL.

Regulations for secondary contaminants address aesthetic concerns, such as imparting an unwanted taste, odor, or appearance to the water. They are not currently based on a risk to human health. There is on-going research into human health effects associated with certain secondary contaminants, such as manganese, which may someday lead to establishing a new enforceable primary drinking water standard (Kondakis et al. 1989; Ljung 2007).

5.1.1 Initial Sampling Requirements for New Sources

New drinking water sources **must** meet the applicable water quality standards for acute and chronic contaminants prior to entry to the distribution system (WAC 246-290-130(3)(g)). The minimum initial water quality testing varies by:

- Type of water system.
- Location within the state.
- Type of source (groundwater or surface water).
- Susceptibility of the source to contamination.

Engineers should collect initial water quality samples from new groundwater sources at the end of the pump test (see Section 5.5.3), so that samples reflect the water quality in the aquifer, and are not an artifact of well construction. You may need to sample other water quality parameters during the pump test; for example, you may need to monitor chloride levels during the pump test when a well is at risk for seawater intrusion (see Section 5.5.4).

The minimum initial required source water quality testing described under WAC 246-290-130(3)(g) includes the following.

- **Bacteriological:** All new source approval requires collection of a coliform sample. We may require additional bacteriological sampling for some groundwater sources and all surface water sources prior to source approval (WAC 246-290-300(a); 300(e); -630(16)(b); -640).

- **Inorganic chemicals (IOCs) and physical parameters:** All new source approval requires collection of a complete IOC sample.
- **Volatile organic chemicals (VOCs):** All new source approval requires collection of a complete VOC sample.
- **Radionuclides:** New source approval for community systems requires collection of a gross alpha and radium 228 sample. Depending on the initial results of that test, we may require additional radionuclide testing for radium 226 and uranium.
- **Synthetic organic chemicals (SOCs) and soil fumigants:** New source approval for community and nontransient noncommunity systems may require collection of SOCs depending on the vulnerability of sources in certain parts of the state. These are usually in agricultural areas, where SOCs and soil fumigants are or were used. We will inform the water system if source approval requires SOC or soil fumigant sampling.
- When we published this manual, we considered adding a new contaminant standard called a state action level (SAL). If DOH adopts a SAL for a previously unregulated contaminant, we will require some or all new sources to sample for that contaminant at the time of source approval.

In addition, we strongly recommend the following water quality testing to develop a more complete understanding of the source water quality and minimize the risk for unpleasant surprises that can lead to expensive treatment steps or decrease consumer confidence in the water supply.

- **Alkalinity:** Alkalinity, together with pH, enables calculation of dissolved inorganic carbon and provides valuable information about the corrosivity of a source.
- **Ammonia:** Ammonia combines with chlorine to form chloramines, which can make the water taste and smell—and affect the corrosivity of the treated water. Knowing the ammonia concentration of the new source will be useful if the water system treats the new source with chlorine.
- **Bromide:** High concentrations of bromide can lead to higher concentration of disinfection byproducts. Knowing the bromide concentration of the new source will be useful if the new source undergoes disinfection treatment, or if the new source of supply combines with a residual disinfectant currently maintained in the distribution system.
- **pH:** An accurate measurement is essential to understanding the corrosivity of a source. Collecting an accurate measurement of pH can be challenging because the pH of water can change rapidly when exposed to air. Accuracy requires that the pH sample be analyzed in the field with a properly calibrated amperometric probe.

- **Phosphate:** The level of phosphate in the water supply may be of interest to municipal wastewater managers if the wastewater treatment discharge permit includes phosphate limits, and can affect the removal of other contaminants.
- **Silica:** High levels of silica can cause etching and staining of glassware and consumer complaints, and can affect the removal of other contaminants.
- **Sulfide:** Hydrogen sulfide can impart an objectionable odor at very low concentrations, which will affect consumer acceptance of the water.
- **Total organic carbon:** TOC combines with chemical disinfectants to increase disinfection byproducts. It can also decrease the effectiveness of treatment processes. Knowing the TOC concentration of the new source will be useful if the new source undergoes disinfection treatment, or if the new source of supply combines with a residual disinfectant currently maintained in the distribution system. Higher concentrations can color the water and decrease consumer acceptance.

5.1.2 Detecting Primary Drinking Water Contaminants

Initial sampling may reveal concentrations of one or more primary contaminants close to, but not exceeding the contaminant MCL. Based on decades of observing water quality trends in existing groundwater sources, we know that water quality can change over time due to natural and man-made influences (declining aquifer, farming and fertilizer practices, development). Two of our state's most common primary contaminants, nitrate and arsenic, vary seasonally or over multiple years for some sources.

For that reason, when a primary contaminant is measured at 75 percent or more of the MCL, the design engineer should describe in the new source project report (see Chapter 2) how the water system will handle exceeding a primary drinking water standard. The project report should carefully consider the following:

- Space for treatment facilities.
- Disposal of treatment waste.
- Construction and operational costs.
- Operating requirements, including level of operator certification.

5.1.3 Exceeding the Primary Drinking Water MCL

If an initial sample from a new source indicates a primary chemical or radiological contaminant above the MCL, we usually require resampling of the source until follow-up results are definitive with respect to compliance with the MCL. Because of the potential

for seasonal changes, the required follow-up sampling may occur over a period of months.

If test results confirm an MCL exceedance and the water system intends to develop the source, the new source design submittal must include physical treatment, blending, or other mitigation to ensure that the water entering the distribution system meets the MCL except as noted below:

For contaminants that have MCLs based on chronic health risks, such as arsenic, we will not require treatment for transient noncommunity water systems unless we determine that the level of the contaminant poses an unacceptable risk to those the water system serves.

See Appendix F for recommended raw water sampling of elements, compounds, or physical characteristics that may affect treatment efficacy. The design engineer should review the water quality characteristics of other drinking water sources in the vicinity and develop a sampling plan to ensure that this information can be collected while the appropriate equipment is on-site. See Chapter 10 for treatment guidance.

Coliform contamination detected at a groundwater source will trigger a source treatment requirement. Microbial contaminants may be introduced while developing a new groundwater source or modifying an existing one. To ensure representative source sampling, design engineers should specify best practices in well development, well completion, and in the handling and disinfection of drilling equipment. In addition, water systems **must** ensure proper disinfection and testing is performed before the well is put into service (WAC 246-290-451). New or modified sources should be purged, disinfected, flushed, and sampled according to the latest AWWA C654 specification for well disinfection.

5.1.4 Secondary Contaminants

We regulate secondary contaminants, such as iron and manganese, for aesthetic reasons. We consider it a best practice for all new sources to meet secondary drinking water standards. If an initial sample from a new source indicates a secondary contaminant above the secondary MCL, we may require resampling of the source until follow-up results are definitive with respect to compliance with the secondary MCL. Because of the potential for seasonality, required follow-up sampling may occur over a period of months.

If test results confirm a secondary MCL exceedance, the system intends to develop the source, and the source supplies a new community or nontransient noncommunity water

system, the new source design submittal **must** include physical treatment, blending, or other actions to ensure that the water entering the distribution system meets the MCL (WAC 246-290-320(3)(d)). See Chapter 10 for treatment guidance.

Existing water systems may avoid treatment for exceeding a secondary MCL if they document that consumers accept the water quality effects and reject the cost of meeting the secondary standard. The design engineer must document construction and operating costs and document consumer acceptance in order to avoid the requirement for treatment. See Appendix F for additional guidance on secondary contaminants.

5.1.5 Groundwater Source Construction-Related Contaminants

Inadequate well development and flushing following construction may result in high turbidity or detection of chemical residuals used in the well drilling process. Collecting initial water quality samples at the end of the pump test will help ensure that sample results reflect the water quality in the aquifer, and are not the result of well construction.

The design engineer should be aware of the risk certain construction materials and practices pose to detection of organic chemicals. Low-level detection of organic contaminants may be the result of residuals associated with well development and construction. It is possible to introduce organic contaminants such as tetrahydrofuran and 2-butanone (components in PVC glue) and toluene (component in lubricants) during well construction. Such construction-related contamination, even in very small concentrations, can result in a significant increase in organic chemical monitoring requirements.

High turbidity in a new well or spring is often an indicator of one or more consequential issues, including:

- **Poor source development.** Inadequate well cleaning following construction may result in high turbidity, and indicate the need to redevelop the source. Collect initial water quality samples at the end of the pump test, so that samples reflect the water quality in the aquifer, and are not a result of well construction.
- **Iron or manganese.** These common inorganic contaminants will cause turbidity and, in most cases, require treatment to remove them from newly developed sources if they exceed the secondary MCL.
- **Groundwater under the direct influence of surface water.** High turbidity measured in wells developed close to lakes, rivers, and springs may indicate direct surface water influence. Conduct additional testing of these types of sources to determine whether there is significant microbial risk from surface water contaminants. See Section 5.7 for additional requirements.

5.1.6 Source Sample Taps

For successful operations, and the ability to demonstrate compliance with drinking water quality standards, engineers must put sample taps in proper locations. Among the attributes of a good sample tap:

- The sample tap outlet faces downward.
- It is in a clean, secure, accessible location.
- It is at least 12 inches above the floor or ground level. When taps are lower than that, water containing coliform bacteria can backsplash into the sample bottle.
- It is where the volume of water flushing from the tap for 5 minutes can easily drain away.
- It is smooth-nosed, without internal or external threads (Ten State Standards 2012).

For more information on good sample tap design and location, see [DOH 331-436](#).

All drinking water sources **must** have sample taps to meet the water quality monitoring requirements of WAC 246-290-300. Sample taps must be:

- At the source, prior to any treatment. Install the sample tap as close to the source as practical.
- After treatment, before entering the distribution system. If there are multiple treatment processes, install sample taps after each unit process. You should install sample taps to allow for adequate mixing between any chemical addition and the sampling location.

See sampling requirements for reservoirs and distribution systems in chapters 6 and 7 and WAC 246-290-300.

5.2 Source Protection

Location is a key factor in securing the highest quality source feasible. In analyzing a source location, design engineers should consider the measures necessary to establish and maintain sanitary or watershed control, physical protection, and barriers to contamination (e.g., surface intake depth, completed well and annular seal depth). Careful consideration of alternatives will reduce, and often eliminate current and future treatment requirements. See [DOH 331-106](#).

The design engineer must describe and document the adequacy of source water protection in each source approval submittal. These requirements protect against

existing or potential sources of contamination (WAC 246-290-135(2)). Required documentation includes:

- **Sanitary control area.** The submittal must include dimension, a description of existing land use and natural features, and documentation of legal control around each proposed source. The design engineer must provide the rationale and a description of factors considered in establishing the sanitary control area. Such factors should include but not be limited to the unique source design, hydrogeologic setting, and land use.
- **Wellhead Protection Program (WHPP).** Water systems **must** determine the location of all potential contaminant sources or activities, and then notify those property owners of the potential to affect the drinking water source (WAC 246-290-135(3)).
- **Susceptibility assessment.** A completed source susceptibility assessment as part of a wellhead protection program (WAC 246-290-135(3)).
- **Covenants.** Water systems must exercise legal control over the SCA, through either fee-simple ownership or other legal means such as restrictive covenants. The source approval packet **must** include signed and recorded copies bearing the auditor's file number. (WAC 246-290-135(2)(e) and (f)).
- **Watershed control program.** Surface water sources and confirmed GWI sources must develop and implement a watershed control program (WAC 246-290-135(4)).

We created several guidance publications on source water protection, including:

- *Covenants for Public Water Supply Protection* (DOH [331-048](#)).
- *Source Water Protection Requirements* (DOH [331-106](#)).
- *Sanitary Control Area Protection* (DOH [331-453](#)).

For a more complete list of groundwater submittal requirements, see Appendix A.3.2. For watershed protection requirements for new surface water supplies, see Chapter 11.

5.3 Distribution Water Quality Effects from New or Modified Sources

Water systems **must** include in the project report how proposed projects could potentially affect water quality in the distribution system (WAC 246-290-110(4)(d)). Blending a new source with existing sources, constructing an intertie, installing treatment, or replacing an existing source with a new one can create water quality

problems in the distribution system. These distribution system water quality effects may include:

- Accumulated inorganic contaminants released from pipe walls.
- Increased metal corrosion.
- Increased disinfection byproduct formation.
- Effects on the ability to maintain a disinfection residual (Taylor et al. 2005; Kippin et al. 2001).

For example, iron or manganese can precipitate after introducing water from a new or modified source with higher dissolved oxygen levels. An increase in hardness and silica levels can lead to water quality issues in the distribution system, such as staining and etching. Changes in flow direction and water age can release scales and accumulated sediments from pipes in the distribution system (Friedman et al. 2010; Hill et al. 2010). These mobilized scales and sediments can contain metals such as arsenic, chromium, and lead (Peng et al. 2012). Design engineers should identify how the water system will address such issues. Common approaches include:

- Bench scale studies.
- Pipe loop studies with new or existing distribution system materials.
- Enhanced monitoring and flushing programs.

Decreasing water's oxidation-reduction potential increases instability of pipe scales, making them more prone to release into the distribution system. Factors that contribute to this problem include:

- Decreased disinfectant residual.
- Decreased dissolved oxygen.
- Decreased alkalinity.
- Decreased pH.

Design engineers **must** evaluate how a change in treatment or introduction of a new permanent or seasonal source may affect compliance with the Lead and Copper Rule (40 CFR 141.81(b)(3)(iii); 141.86(d)(4); and 141.90(a)(3)). This evaluation is especially important for water systems assigned optimum water quality parameters under the Lead and Copper Rule and proposing to develop a new source. The design engineer should review the water quality characteristics of other drinking water sources near the proposed source, and develop a sampling plan to ensure that new source water quality information can be obtained while the appropriate equipment is on-site as the well is

being developed. Examples of new source characteristics that could increase corrosivity, lead, and copper solubility, and cause other distribution system issues include:

- Change in pH, alkalinity, and dissolved inorganic carbon.
- Increase in the chloride-to-sulfate mass ratio from sources with elevated concentrations of chloride ions.

We may require water systems that introduce a new source of supply to restart lead and copper distribution system monitoring (40 CFR 141.86(d)(4)(vii)). See Section 10.1.3 for information on addressing changes in treatment to an existing source.

Lastly, introducing a new source can affect the way that water flows in a distribution system. Changes in the direction of flow and velocities can mobilize particles in the distribution system leading to customer complaints, and changes in disinfectant demand. As a result, the design engineer and water system should assess the potential for changes in distribution system hydraulics and take steps to mitigate

5.4 Source Water Quantity and Reliability

The source or sources for a water system **must** be able to meet the water system's maximum day demand (MDD) (WAC 246-290-222(4)). For reliability purposes, supply sources should be able to replenish depleted fire suppression storage within 72 hours (or sooner if required by the local fire authority) while concurrently supplying the MDD of the water system. For wells and other pumped sources, we recommend establishing source water quantity based on pumping no more than 20 hours per day. See Sections 3.10 and 4.4.2 for additional guidance.

After deciding the new source's capacity, design engineers should check that the reservoir overflow capacity is sufficient to discharge the combined sources of supply available to the reservoir without damage to property or surcharging the reservoir structure. These source of supply to a reservoir include discharges from all wells, interties, pressure reducing valves, and booster pump stations that serve the pressure zone in which the reservoir is located.

5.5 Wells

Most of the source development projects in our state are drilled wells and well fields (see the *Well Field Designation Guideline* in Appendix B.1). See Chapter 2 and Appendix A for guidance on preparing a project report and the construction documents for a new

well. See Appendix E for well pumping test standards. See [Policy M.01](#) for requirements on pitless units and well caps.

The design engineer should use a pump test or hydrogeologic analysis to determine how reliable groundwater or aquifers will be over time. We expect pumping tests to run at a flow-rate greater than or equal to the maximum design pumping rate (WAC 246-290-130(3)(c)(iii)).

Design engineers may reference well source development data from nearby sources as supplemental evidence that water quantity is adequate to meet design criteria. If the aquifer setting is well characterized and quantified, and hydrogeologic information is adequate to establish a sustainable pumping rate, then the engineer may submit a hydrogeologic report to justify the proposed pumping rate. A licensed hydrogeologist should prepare the report. It should include a detailed analysis of the well, aquifer, and local conditions including effects on nearby sources of supply.

5.5.1 Steps to Take Before Drilling a Well

Taking these steps before drilling the well will help you develop the highest quality source feasible and facilitate a quick and efficient design review process.

Before drilling a well, you **must**:

- Obtain a notice of intent to construct a well from the Department of Ecology (WAC 173-160-151).
- Ensure that a licensed well driller will drill the well and that well construction is done according to chapter 173-160 WAC.
- Obtain a well site inspection by state or local health jurisdiction staff (WAC 173-160-171(3)(c)).

Before drilling a well, you should:

- Prepare and submit for DOH review and endorsement the well pumping test plan. While developing the pump-testing plan, refer to Appendix E.
- Evaluate the possibility of obtaining alternate sources of supply through interties with neighboring water systems or already developed wells.
- Conduct a preliminary hydrogeologic assessment, which includes preparing a Wellhead Protection Potential Contaminant Source Inventory.
- Contact DOH to learn the parameters used to delineate groundwater under the direct influence of surface water (GWI). You **must** have a determination of the GWI status prior to source approval (WAC 246-290-130(3)(d)). If a well meets our

criteria for a potential GWI (for example, less than 50 feet deep and within 200 feet of a surface water body), you will need data to determine whether the source connects hydraulically to surface water, and to what extent. See Section 5.7 for additional information used to evaluate potential GWI sources.

- Obtain a legal right through an ownership option or recorded covenant to prevent potential sources of contamination from locating within the standard sanitary control area (normally a 100-foot radius around the well).

Before drilling, you should make sure that the water system can control land use within the sanitary control area (SCA) (100-foot radius around the well) through fee-simple ownership, a protective covenant, or other mechanism—and have DOH or the local health jurisdiction conduct a well site inspection. During the well site inspection, you should identify any limits on controlling the entire SCA and give the state or local health representative a map of the SCA. With these items, you should talk to the representative about evaluating the site conditions. Be sure to allow time to identify possible mitigation measures, such as a deeper surface seal during well construction.

5.5.2 Documenting Wellhead Protection

The SCA **must** have a radius of 100 feet, unless justification demonstrates that a smaller area can provide an equivalent level of source water protection (WAC 246-290-135). The justification should address geological and hydrological data, well construction details, mitigation measures, and other relevant factors necessary to ensure adequate protection of source water quality. Major factors influencing a decision to allow a smaller than standard SCA include depth of the screened interval and “confinedness” of the water-bearing zone. We may require a larger SCA, additional mitigation measures, or both if land use, or geological or hydrological data support such a decision.

Before we can approve the proposed source, the water system **must** be able to provide the dimensions, location, and legal documentation of the SCA (WAC 246-290-135(2)). We require the water system to “control” the SCA to prevent any potential source of contamination from being constructed, stored, disposed of, or applied within the sanitary control area. To ensure the water system can control the SCA, we require it to own the SCA outright, or to have the right to exercise complete sanitary control of the land through other legal provisions restricting the use of the land, such as a duly recorded declaration of covenant.

To evaluate the appropriateness of a proposed drilling location, you should conduct a preliminary susceptibility assessment, complete a preliminary WHPA delineation and initial contaminant inventory, and map the findings.

A preliminary susceptibility assessment will give design engineers and DOH information to evaluate the suitability of the proposed well site before drilling a well and before expending significant resources. It may be helpful to ask DOH for guidance on conducting a preliminary susceptibility assessment before selecting a potential well site. The assessment should help you understand the influence variables, such as length of well screen or open hole, have on WHPA delineation. The assessment can identify the benefit of developing the well in a confined versus unconfined aquifer.

The minimum standard for delineating the wellhead protection area is the “Calculated Fixed Radius” method. We encourage you to use more sophisticated and accurate methods of delineation, such as analytical or numerical modeling to ensure a higher level of source protection. See our [Wellhead Protection Program Guidance Document](#) (DOH 331-018) for further explanation of these methods. The WHPA delineation should identify the 6-month, and the 1-, 5- and 10-year time of travel boundaries. Conduct a survey for potential sources of groundwater and source water contaminant in the WHPA area. More information is on our [Source Water Protection](#) webpage.

5.5.3 Groundwater Pumping Tests

Design engineers can use pump tests to assess how reliably groundwater can meet the demands of a projected population over time. See Appendix E for detailed guidance on pumping tests. The design engineer **must** ensure the pumping test provides sufficient data to achieve its objectives (WAC 246-290-130(3)).

The objective of the pumping test is to acquire data identifying the source’s safe yield and maximum design pumping rate, to establish well pump-depth setting, and to size and select the well pump. Factors that could influence reliability include low-flow conditions, fracture-flow conditions, aquifer of limited areal extent, seawater intrusion, effects of concurrently pumping multiple wells, and seasonal variability.

The timing of a pump test may be more or less important to determining safe yield, depending on the aquifer setting. Seasonal and annual climate conditions have less influence on groundwater than surface water, except in sensitive settings such as shallow alluvium aquifers and in some areas where localized recharge “lenses” occur. The design engineer should determine whether a proposed groundwater source is in a sensitive setting and design the pump test accordingly.

After the pumping test, design engineers **must** compile the following data into a project report, and submit it to us as part of the source approval documentation (WAC 246-290-130(3)(c)):

- All items for source approval, if applicable.
- A time-drawdown graph (on standard and semi-log paper).
- An analysis and discussion of applicable hydraulic parameters (such as transmissivity, hydraulic conductivity, storativity), as appropriate, to support the objectives of the pumping test.
- A map and description (1/4, 1/4, section, township, range) accurately indicating the well location and the land surface elevation to the nearest foot. Locate observation wells with distances to the nearest foot.
- A well report.

The end of the aquifer pump test is a good time to collect the water quality samples required for source approval.

5.5.4 Seawater Intrusion

Wells or well fields developed close to seawater may be vulnerable to seawater intrusion. Seawater intrusion caused by over-pumping the basal (freshwater) lens degrades groundwater quality by drawing chloride (from seawater) into the remaining fresh groundwater. Department of Ecology rules prohibit degradation of the state's groundwater. We recommend that water systems have a hydrogeologist or qualified engineer assess the potential for seawater intrusion and oversee well testing. See Appendix E for guidance on developing sources vulnerable to seawater intrusion. Wells at risk for intrusion include wells located:

- Within ½ mile of the shoreline and pump water from a depth below sea level.
- Within ½ mile of a groundwater source with chloride concentrations over 100 mg/L.

The design engineer should avoid supply sources at risk for seawater intrusion. Ecology may condition water right permits to provide for reduced pumping rates or may even require a water system to abandon sources if seawater intrusion threatens senior water right permits. In addition, several counties have policies or ordinances affecting water systems in areas vulnerable to seawater intrusion. We recommend that the design engineer contact Ecology and the local health jurisdiction for current policies or rules on developing wells where seawater intrusion may be a concern.

5.6 Spring Sources

A design engineer submitting a spring source for approval **must** identify (WAC 246-290-130(3) and -135):

- The safe yield of the spring.
- Water quality meets all applicable drinking water standards.
- Measures to protect the sanitary control area and water quality of the spring supply from contamination at all times.

5.6.1 Spring Source Safe Yield

It may be difficult to determine the safe yield of flow from a spring. Pumping test procedures usually do not apply to springs because the recharge is unidirectional and associated only with the flow delivered at the ground-surface interface. Therefore, to measure spring-flow quantity, design engineers should use actual flow records (with weirs or other mechanisms capable of measuring surface flows) during high- and low-flow conditions over a variety of seasonal conditions. At minimum, we recommend measuring spring flows at least monthly for at least 12 months (Meuli & Wehrle, 2001).

Because drought conditions often influence spring flows, it is appropriate to estimate the flows that would prevail during drought. You should collect precipitation data along with measured spring flows. Compare spring-flow data with precipitation data from previous years to estimate the safe yield and minimum flows from the spring. Appendix C includes climatological organizations (NOAA, Office of State Climatologist, Western Regional Climate Center) with data that may help you determine how current-year precipitation compares with historic weather patterns.

In evaluating the safe yield of a spring source, we recommend that the design engineer use the 50-year low-rainfall year. Spring flows are inherently uncertain and subject to significant changes in precipitation patterns. To the extent possible, correlate spring discharge (or daily capacity if pumped) to the 50-year drought and establish the design yield on that basis. If accurate rainfall and spring discharge data are not available, apply a safety factor to the "usual" or "average" known capacity of the spring to estimate yield during very dry periods.

5.6.2 Spring Source Water Quality

Because springs are potential GWI sources (see Section 5.7), the design engineer **must** establish whether the spring source is GWI (WAC 246-290-130(3) and -640). The content of the project report for a spring must address groundwater or surface water source-approval, depending on the outcome of the GWI determination.

Spring sources are at significant risk of surface contamination. Springs that have a greater degree of seasonal fluctuation in flow have a higher the risk of contamination (Meuli & Wehrle, 2001). Engineers **must** design the spring catchment and conveyance

systems to minimize the risk of direct surface water infiltration; otherwise, we will consider the spring source a surface water supply subject to all applicable sections of WAC 246-290 Part 6.

In many cases, we will require springs not otherwise subject to the requirements of the surface water treatment rule to provide CT6 disinfection treatment (4-log virus inactivation) before the first connection (WAC 246-290-451(4)) and WAC 246-290-640(4)). We also may require sanitary protection of the source beyond the minimum 200 feet required in WAC 246-290-135.

In general, unique geological conditions will dictate the steps design engineers will follow when developing a spring source. Design engineers should tailor their design and construction activities to protect the spring, and the areas above the spring, from surface contamination.

- Construction materials **must not** create an opportunity for water quality problems (WAC 246-290-220).
- The design should provide surface water runoff diversions.
- Designs for spring collectors and catchment facilities **must** prevent infiltration of contamination (WAC 246-290-130(3)).
- Designs **must** provide protection from vandalism (fencing, lockable hatches, and other security measures) (WAC 246-290-130(3)).
- Requirements for screening vents or other openings appropriate to the spring are similar to those for distribution reservoirs (see WAC 246-290-235).

The design engineer can get guidance and specific details on spring development, sanitary protection, and water quality considerations from the references listed at the end of this chapter (AWWA 1999; USEPA 1991; Meuli & Wehrle, 2001).

5.7 Groundwater under the Direct Influence of Surface Water

Groundwater under the direct influence of surface water (GWI) is any water beneath the surface of the ground with one of the following:

1. Significant occurrence of insects or other macro organisms, algae or large diameter pathogens such as *Giardia lamblia*.
2. Significant and relatively rapid shifts in water characteristics such as turbidity, temperature, conductivity, or pH, which closely correlate to climatological or surface water conditions (WAC 246-290-010).

Water systems with sources confirmed to be GWI **must** comply with the filtration and disinfection requirements for surface water sources (WAC 246-290, Part 6).

Water systems **must** evaluate all potential GWI sources to determine whether additional treatment is necessary (WAC 246-290-640). Potential GWI sources include (WAC 246-290-010):

- Wells with a first open interval less than 50 feet below the ground surface and are located within 200 feet of surface water.
- Springs.
- Infiltration galleries.
- Ranney wells.

While reviewing source approval information, we may determine that a source other than those listed above is potentially GWI, and subject to the GWI evaluation process. An example of such a source is a well located on a bluff above a nearby stream. The depth to the first open interval may be greater than 50 feet as measured from the top of the casing, but be less than 50 feet as measured from the stream's high water elevation. We may add additional criteria to evaluate potential GWI sources based on recent research (Stokdyk et al. 2019)

We will not approve a new potential GWI source before a proper evaluation. Figure 5-1 at the end of this chapter outlines the evaluation process for potential GWI sources. The project report **must** document the details of the GWI evaluation, including how you will simulate anticipated source withdrawal conditions for new (not yet in service) potential GWI sources (WAC 246-290-130(3) and -640). For planning purposes, design engineers should schedule at least 18 months to complete the GWI evaluation process.

We do not require potential GWI sources determined not to be GWI to meet the treatment requirements for surface water sources. However, potential GWI sources determined to be in hydraulic connection with surface water **must** provide minimum CT6 disinfection before entering the distribution system (WAC 246-290-451(4), WAC 246-290-640(4), and [Policy F.12](#)). For additional guidance on evaluating potential GWI sources, see the references at the end of this chapter (WSDOH 2003a; WSDOH 2003b).

5.8 New Surface Water Supplies

Because it may be difficult to secure necessary permits from natural resource agencies and other involved parties, it can take many years to develop a new surface water

supply. For example, new surface water sources trigger a detailed environmental review requirement under the State Environmental Protection Act (SEPA).

In addition to treatment, the design engineer should consider the unique features of surface sources when evaluating them for the drinking water supply. Often, several competing beneficial uses (agriculture, fisheries, and other resource demands) affect the long-term reliability of surface sources. Water rights may be very difficult to secure. A secured water right may be so restricted during some periods, that little or no portion of the source can be used to supply drinking water (see Interruptible Water Rights, Section 5.12.2). The reliability of a surface source is more uncertain than groundwater because it relies so heavily on precipitation levels (rain and snow), and is vulnerable to reduction in withdrawal due to low stream flow.

Surface water sources also are more vulnerable to contamination than protected groundwater supplies. Design engineers should thoroughly assess the vulnerability of the source to natural disasters (floods, wildfires, and landslides) and human activities (waste disposal, spills, and runoff from agricultural activities). New surface sources **must** conduct detailed source water monitoring to assess the degree of microbial risk. High-risk sources require a higher level surface water treatment (WAC 246-290-630(16)(b); 40 CFR 141.702(f)).

Surface water supplies normally require conventional, direct, slow sand, diatomaceous earth filtration, or an approved alternative treatment technology and **must** comply with the Surface Water Treatment Rule and WAC 246-290, Part 6. See detailed design criteria in WAC 246-290, Chapter 10 of this manual, and the *Recommended Standards for Water Works* (Ten State Standards 2012). Introducing a new surface water supply may cause water quality changes in the distribution system. Engineers **must** evaluate the potential for such changes in a project report (See Section 5.3).

Design engineers planning to submit new or modified surface water treatment designs **must** first perform a pilot study to evaluate alternatives (WAC 246-290-250; WAC 246-290-676(3)). Section 10.3 provides detailed guidance on treatment predesign and pilot studies. In some cases, design engineers may need DOH and natural resource agencies to approve the intake facilities before initiating the pilot study.

Design engineers can help to ensure an efficient and orderly review of their surface water treatment proposals by meeting with our [regional office](#) staff to establish specific design requirements.

Water systems should develop surface sources with full knowledge that some reductions in service capacity may result over time as low rainfall years, low snowpack years, or drought conditions occur. Water systems will need to compare historic hydrological data against customer service expectations to gauge the adequacy of the source.

5.8.1 Surface Water Safe Yield

Yield from a surface water source depends on climatic influences from year to year. Design engineers can use flow measurements and hydrologic assessments with an appropriate factor of safety to measure the “safe yield” of a surface water source. However, when defining expectations for long-term service, engineers should base the reliability of flow from these sources on years with the lowest precipitation levels.

In general, the safe yield of a surface water reservoir is the reliable withdrawal rate a watershed provides through the critical drought period. We recommend using a 98 percent level of reliability, equivalent to a 50-year drought, for surface supplies. We used various references to develop this recommendation (Prasifka 1988; HDR 2001; City of Seattle, 2013). Engineers should address instream flow reservations and other natural resource effects when assessing the safe yield of the water resource during drought.

Appendix C includes climatological organizations with data that may help engineers determine how current-year precipitation compares with historic weather patterns. Appendix C also includes a link to Department of Ecology’s stream flow database.

5.9 Purchased Water and Emergency Interties

Interconnections (interties) between water systems are an alternative to developing new supply sources. Interties can help provide a level of reliability difficult to secure otherwise.

A design engineer considering an intertie to augment supply sources **must** satisfy the requirements of WAC 246-290-100 and -132. These requirements exist to ensure the wholesaling and consecutive systems have the physical and legal capacity to sell and purchase the expected volume and flow of water. Planning and engineering documents submitted to support constructing a new or expanding consecutive system **must** include the intertie agreement. There are different standards for emergency interties and purchased water (nonemergency interties).

Designs should include provisions for verifying water meter accuracy, and collecting water quality samples by staff from both water systems at the intertie. You should consider provisions for continuous online instrumentation. See Section 10.4.2.

5.9.1 Reliability of Purchased Water (Nonemergency Interties)

New and existing public water systems may purchase their water supply in whole or in part from another water system. The design engineer **must** assess the reliability of a purchased water agreement, and demonstrate how the intertie improves overall system reliability (WAC 246-290-132 (3)(a)(v)). Water systems **must** satisfy the requirement to provide an adequate quantity and quality of water in a reliable manner (WAC 246-290-420 (1)).

A design engineer submitting a new or renewed wholesale water agreement that raises reliability concerns (see list below) **must** submit a viable plan identifying an alternative water supply. That supply **must** satisfy the requirement to provide an adequate quantity and quality of water in a reliable manner (WAC 246-290-420 (1)) if an intertie agreement is terminated. When submitting the agreement, the design engineer **must** also submit evidence that the wholesaler's service capacity assessment reflects its full allocation of water, storage, and/or booster-pumping capacity to the consecutive system (WAC 246-290-222).

Terminating the water supply according to provisions written into a purchased wholesale water agreement is not an abnormal operating condition. To improve reliability, we believe wholesale water agreements should not be subject to termination except for customary reasons (e.g. failure to pay). The criteria below reflect this principle.

Recommended attributes of a wholesale water agreement:

- How and when charges are calculated and billed.
- When payment is due, and what happens if payment is past-due.
- Description of whether or how much standby storage and/or fire suppression storage is available to the consecutive system.
- Adherence to cross connection control requirements at the point of service.
- How the water rate(s) is adjusted over time.
- Absolute and seasonal limits on instantaneous flow and annual volume.
- Limits on type and place of use.
- Impact of a declared emergency or natural disasters.

Attributes of a wholesale water agreement that raises reliability concerns:

- Date-based termination clause (e.g., "this agreement is valid for 10 years").
- Needs-based termination clause (e.g., "this agreement may be terminated at any time due to unforeseen circumstances that result in a limited water supply that will be allocated to in-city customers").

- Short-term unilateral termination clause (e.g., “this agreement may be terminated after 30 days’ notice by either party”).

A consecutive system purchasing water through an intertie may need to treat the purchased water to maintain compliance with drinking water standards (e.g., maintaining a free chlorine residual in the consecutive system’s distribution system) or to avoid distribution system water quality effects such as those described in Section 5.3. A consecutive system also may incur additional sampling requirements, such as for disinfection byproducts and Ground Water Rule triggered sampling.

We may approve planning and engineering documents based on the following types of purchased water agreements. These agreements fall into a spectrum of risk to interruption, from practically no risk of interruption to near certain risk of termination.

- **Regional Water Supply Agreement** (very reliable). A consortium of water systems receives its water supply from commonly held and proportionally owned source and transmission infrastructure. Member systems operate and maintain this shared infrastructure. In these cases, there is little to no increased risk of interruption in supply to any individual member.
- **Bought-In Wholesale Capacity Agreement** (very reliable). A single utility wholesaler permits one or more other water systems to buy-in to the wholesaler’s supply and transmission infrastructure, similar to a retail water customer paying a system development charge to a water system for the privilege of receiving water service. This investment ensures the participating water systems receive a proportional or fixed share of the supply, but does not give them a say in the operation or maintenance of those supplies. In these cases, there is little to no increased risk of interruption in supply to any of the participating water systems.
- **Purchased Wholesale Water Supply Agreement** (Poor reliability). A single utility wholesaler agrees to sell water to one or more consecutive water systems. There is no ownership stake held by any of the consecutive systems. The wholesale agreement may not be renewable and/or may be terminated at the option of the wholesaler (such contracts are common). As a result, there is a greater risk of supply interruption.
- **Reserve Infrastructure Agreement** (Variable reliability). A wholesaler makes a portion of its capacity (source water, stored water) available to a consecutive system for use as a reserve source, thus saving the consecutive system from the full cost of investing in its own standby infrastructure. The wholesaler should account for the

transfer of standby capacity in its own planning. The intertie valve should be automatic. The risk of interruption in standby reserve capacity (e.g., providing fire suppression flow or storage, or providing standby storage) depends on the content of each agreement.

5.9.2 Emergency Interties

An emergency intertie can often be a cost-effective way to reduce the risk of supply interruption. Because of the difference in design approval requirements, it is important to establish the difference between an emergency intertie and a nonemergency intertie.

If the intertie satisfies **all** of the following criteria, it is an emergency intertie:

- The consecutive system's own source(s) of supply, booster pumps, and reservoirs can meet the maximum daily demand (MDD) and peak hourly demand (PHD) while maintaining the design standards of WAC 246-290-230 without supplemental supply delivered through the intertie.
- The challenges the two parties intended to address with the emergency intertie, and documented in the intertie agreement, are limited to one or more of the following:
 - Temporary failure of one or more nonemergency source where the remaining sources of supply cannot maintain 20 pounds per square inch (psi) during PHD throughout the consecutive system's distribution system.
 - Fire where the consecutive system's own system cannot meet the fire suppression requirement (flow rate and duration) combined with MDD while maintaining 20 psi throughout the distribution system.
 - Water quality emergency.

The original circumstances and associated design intent of the intertie may change with time. In the transition from an "emergency use intertie" to a "nonemergency intertie," the design engineer should make sure that the water system meets all the applicable requirements of WAC 246-290-132.

RCW 90.03.383 addresses intertie approvals intended to resolve emergent public health concerns, short-term emergencies, and drought emergencies. RCW 90.03.383 (2) states an "emergency-use intertie" does not trigger a requirement to change the upstream water system's water right, and does not require a place-of-use change. As stated in Section 4.4.2, designers **cannot** include emergency sources, including emergency interties, in the total source capacity calculations (WAC 246-290-222(3)).

5.10 Unconventional Sources

Many watersheds are limited in their capacity to supply water for growth and development while maintaining sufficient stream flow. Consequently, design engineers may look to unconventional sources such as rainwater collection and seawater desalination to develop into drinking water supplies. Before approving an unconventional source, the design engineer **must** complete a thorough alternatives analysis to determine the highest quality source feasible for the water system (WAC 246-290-130).

5.10.1 Rainwater Collection

For DOH, rainwater is surface water, subject to all the requirements of the Surface Water Treatment Rule. Collected rainwater often has significant fecal contamination and other contaminants (Ahmed et al. 2012; Birks et al. 2004; Lye 2002; Osterholt et al. 2007; Hoque et al. 2003). Any public drinking water system that uses collected rainwater **must** provide treatment, including filtration and disinfection in compliance with the Surface Water Treatment Rule. Surface water treatment design requirements, ongoing operations and maintenance requirements, and daily monitoring and monthly reporting requirements are in WAC 246-290 Part 6. Design submittal requirements for rainfall catchment are significant. See Appendix F.7.

Rainwater is slightly acidic and low in dissolved minerals. These qualities make it corrosive to metals and other materials. The rooftop collection material and coating systems **must** meet ANSI/NSF Standard 61 or NSF Standard Protocol P151 to reduce the risk of chemical contaminants (WAC 246-290-220). In addition, the water system may have to install corrosion control treatment to overcome rainwater's natural corrosivity.

Rainwater collection systems intended for nonpotable uses are a cross-connection control hazard, especially if the system delivers rainwater through dedicated internal plumbing. Therefore, any water system providing service to a building with a rainwater collection system **must** protect the water distribution system from contamination by cross connections (WAC 246-290-490).

Reliance on rainwater is problematic due to drought and extended dry periods that occur even in the wettest parts of this state. Washington has less rainfall during the summer, which is the period of greatest water demand for most water systems. The design engineer for a rainfall collection system **must** evaluate rainfall, usage patterns, and water storage thoroughly to ensure a reliable supply (WAC 246-290-130(3)). See Appendix F.8 for guidance on assessing adequacy of rainfall collection as a drinking water supply.

As with any surface water supply, the safe yield of a rainfall catchment system is the sustainable rate of water withdrawal from the cistern through the critical drought period. We recommend using a 98 percent level of reliability, equivalent to a 50-year drought, for rainfall catchment systems. Rainfall varies in Washington on an annual, seasonal, and regional basis. This supply variability makes reliance on rainwater collection as the sole source of potable water supply impractical for nearly all public water systems.

5.10.2 Trucked and Hauled Water

We will not approve trucked or hauled water as a permanent drinking water supply to new or existing public water systems. We do not recognize trucked water as a reliable permanent source of supply. Trucked water in unpressurized conditions poses an increased health risk. We acknowledge the need to use trucked or hauled water as a temporary, last-resort measure to meet basic public health requirements in response to an emergency, but only for the period a public water system lacks access to an adequate and safe drinking water supply. See DOH [331-063](#).

5.10.3 Desalination

Desalinating seawater or brackish groundwater is technically feasible and may be the only option available in some situations. Design engineers should consult with us before initiating a desalination project, and should contact other county, state, and federal agencies early in the design process to identify potential permitting issues. See Chapter 10 and Appendix F.6 for design guidance associated with brackish water and seawater desalination.

5.10.4 Aquifer Storage and Recovery

Aquifer storage and recovery (ASR) increases existing groundwater supplies by artificially recharging and storing groundwater. ASR is a water resource strategy designed to take water when it is available and store it in an aquifer deemed appropriate for later withdrawal and beneficial use. Several water systems in Washington implement ASR, including the Sammamish Plateau Water and Sewer District and the cities of Walla Walla, Yakima, and Kennewick.

We do not have primary responsibility to oversee or approve ASR projects. The Department of Ecology implements the ASR permitting process (Chapter 90.03 RCW) with standards for review established in [Chapter 173-157 WAC](#). The permitting process is challenging, and requires applicants to provide documentation, including demonstration through actual and/or modeled hydrogeologic conditions:

- **The recoverable percentage of water pumped into the aquifer.** For the applicant, the economic feasibility of the project usually depends on the adequate recoverable volume of water. Successful ASR applicants own the right to use the recoverable portion of the water they store underground.
- **ASR must not degrade groundwater quality.** There could be negative effects associated with pumping treated surface water or reclaimed water into an aquifer; and ASR projects **must** comply with state water quality standards (Chapter 173-200 WAC).

In addition to meeting Ecology’s permitting requirements, ASR projects developed to augment an aquifer’s capacity to supply drinking water, must eventually satisfy public drinking water source requirements. Design engineers pursuing a drinking water-related ASR project should concurrently satisfy all applicable sections of WAC 246-290.

5.11 General Source Design Considerations

We consider several other design elements associated with new or existing drinking water sources when reviewing design documents and subsequent reports.

5.11.1 Power Supply Reliability

To avoid the attendant risk of backflow contamination when some or all of the distribution system depressurizes, design engineers **must** consider the reliability of the power supply grid if the proposed system has no provision to maintain pressure during a power outage (WAC 246-290-001, -200).

The supply source(s) for a water system **must** be able to meet the water system’s MDD (WAC 246-290-221). See our water supply reliability recommendations in Sections 3.10, 5.4, and 5.8. We consider a reliable power supply as defined below:

- **Frequency:** On average, three or fewer power outages occur per year based on data for the three previous years, and no more than six outages occur in a single year. Power loss for 30 minutes or more qualifies as an outage.
- **Duration:** On average, outages last less than four hours based on data for the three previous years, and no more than one outage exceeded eight hours during the same timeframe.

If a power supply to a source, pump station, or treatment plant cannot meet the minimum standards described above, then we consider the power supply unreliable and the water system **must** take further reliability measures (WAC 246-290-420(4)). Section

3.2 of the *Recommended Standards for Water Works* contains additional design guidelines on this issue.

If the water system power supply is unreliable, the design engineer should consider one or more of the following measures:

- Make in-place auxiliary power available (auto transfer capable)
- If there are two or more sources, connect each to a different electrical substation
- Construct and maintain adequate gravity standby storage (see Chapter 7)
- Connect to two independent primary public power sources

5.11.2 Criteria for Multiple Sources or Multiple Pumps per Source

We encourage water systems to have multiple supply sources. Multiple sources help to ensure operational reliability if a mechanical, electrical, treatment, or structural problem causes a source to fail. Multiple sources may offset recommended standby storage (SB) volumes.

We recognize that multiple pumps for a single source may be more reliable than a single-pump. However, we do not consider a single source with multiple-pumps to be as reliable as multiple sources. Design engineers should address the following criteria when seeking approval to consider multiple pumps in a single well as equivalent to multiple sources for evaluating a reduction in SB volume (see Section 7.1.1.3).

- It is possible to take each pump out of service without depressurizing the water system. Water systems should consider establishing an emergency on-call service contract with a qualified repair or service entity to minimize down time.
- The well design includes an alarm to signal a pump failure.
- The submittal includes an operational plan to address repairs and minimize downtime (WAC 246-290-415).
- The well(s) should be easy to access for repairs and pump removal.

For further consideration, bear in mind the risk of contaminating a single well with multiple pumps. A second pump in the well addresses mechanical failure of a single pump, but two pumps cannot overcome contamination of the source. Consider the need for an expanded, more robust sanitary control area for a multiple pump source.

5.12 Water Resource Analysis and Water Rights

As part of the source approval process, the engineer **must** do a water resource analysis to study and address water rights issues (WAC 246-290-130(3)). A water resource analysis **must** evaluate opportunities to obtain or optimize the use of sources already developed, or other ways to meet water needs (WAC 246-290-100 (4)(f) and 110(4)(c)).

Water supplies for Group A water systems **must** conform to state water right laws (WAC 246-290-130(3)(b) and (4)(a)). Water systems that submit new source development or other growth-related projects for our review and approval (WAC 246-290-100(4) or 110(4)(e)) **must** include a [Water Rights Self-Assessment Form](#) (WAC 246-290-130(4)(a)). We review the information provided on this form to ensure the water system has adequate water rights to meet the projected increased ability to provide service.

5.12.1 Temporary Water Rights

The Department of Ecology issues temporary water rights for two reasons:

- Short-term use with an associated expiration date.
- Water use while an application for a traditional water right is pending review and final decision.

We will not increase an existing water system's service capacity solely because it secures a temporary water right. We may approve a new public water system based on a source of supply with a temporary water right under the following conditions:

1. Water service is prohibited to any permanent structure or permanent use.
2. The financial planning section of the design submittal or project report reflects the expiration date and the inability to renew the temporary water right, and the local government land-use decision reflects and supports the temporary use.
3. The title of the property the temporary water right serves reflects the limitations and attributes of the temporary water right, and includes a DOH-approved disclaimer.

5.12.2 Interruptible Water Rights

Design engineers considering a new or expanding public water system dependent on interruptible water rights **must** demonstrate the water system has access to an uninterruptible instantaneous supply sufficient to meet basic maximum daily demand requirements, and an uninterruptible volumetric supply sufficient to satisfy the system's nondiscretionary average daily water demands (WAC 246-290-230). We consider access to an adequate uninterruptible supply to include:

- An uninterruptible instantaneous supply equal to at least 350 gallons per day (gpd) per ERU (WAC 246-290-221 (4)) (See *Baseline Residential Water Demand* in Appendix D).
- A volumetric supply sufficient to serve at least 200 gpd per ERU during the entire period of interruption.

During the entire period of interruption, the water system **must** remain capable of providing the fire flow the local fire control authority determined necessary (WAC 246-290-221(5)).

The water system **must** submit a plan for temporary demand curtailment during the design period of interruption (WAC 246-290-420 (1)). If the temporary demand curtailment plan does not describe a credible and enforceable plan to limit demand, we may seek in the design an increase in the maximum daily demand (MDD) and/or an increase in average daily demand (ADD).

We recommend planning to mitigate the maximum duration of an interruption based on a 50- year low-flow for the supply source(s). Design engineers should ask Ecology for the estimated duration of interruption based on a 50-year low flow in the source(s) of supply

5.12.3 Leased Water Rights

A water lease from a federal agency, such as Bureau of Reclamation, is irrevocable and renewable in perpetuity. Consequently, we consider federal leases reliable and appropriate for approval of a new or expanding water system.

However, we do not recognize other leased water right contracts as a reliable source of supply. These arrangements risk a permanent water supply interruption if the owner revokes or does not renew the lease, or the water system cannot obtain a permanent water right before the lease contract expires.

In most circumstances, the design engineer **must** demonstrate service capacity based on the ability to supply 350 gallons per day per ERU under a non-leased water right(s) (WAC 246-290-221 (4) and 246-290-420 (1)). In addition, the water system **must** submit a plan for permanent demand curtailment (WAC 246-290-420 (1)). If the permanent demand curtailment plan does not describe a credible plan to limit demand, we may require the engineer to use a greater maximum daily demand (MDD) and/or a greater average daily demand (ADD) in the water system design.

5.13 Placing a New or Modified Source into Service

Before a new or modified source can be placed into service, it **must** be properly inspected, disinfected, and tested (WAC 246-290-120(4) and -451(1)). Design engineers usually use the [WSDOT/APWA standard specifications](#) (Division 7) and *AWWA C651–Standard for Disinfecting Water Mains* to define pressure, leakage, and disinfection standard practices (WSDOT/APWA 2016; AWWA 2014) for pipelines installed as part of a new or modified source. *AWWA C654–Standard for Disinfection of Wells* is the disinfection and testing standard for new or modified wells (WAC 246-290-451(1)) (AWWA 2013). The specific standards used for the project should clearly identify:

- Inspection and flushing requirements.
- Pressure and leakage testing methods.
- Disinfection and bacteriological testing methods.

The new or modified source may be placed into service **only after** the water system properly disinfects it according to industry standards, testing results show the water from it is safe to drink, and the engineer in charge of the project submits a [Construction Completion Form](#) to DOH (WAC 246-290-120(5); WAC 246-290-125(2)(b)).

References

- Ahmed, W., Hodgers, L., Sidhu, J. P. S., & Toze, S. 2012. Fecal indicators and zoonotic pathogens in household drinking water taps fed from rainwater tanks in Southeast Queensland, Australia. *Applied and Environmental Microbiology*, Vol. 78, Issue 1, pp. 219-226.
- AWWA. 1999. *Design and Construction of Small Water Systems*, 2nd Edition, American Water Works Association, Denver, CO.
- AWWA. 2013. *C654 - AWWA Standard for Disinfecting of Wells*. American Water Works Association, Denver, CO.
- AWWA. 2014. *C651 - AWWA Standard for Disinfecting Water Mains*. American Water Works Association, Denver, CO.
- Birks, R., Colbourne, J., Hills, S., & Hobson, R. 2004. Microbiological water quality in a large in-building, water recycling facility. *Water Science & Technology*, Vol. 50. Issue 2, pp. 165-172.
- Friedman, M.J.; Hill, A.S.; Reiber, S.H.; Valentine, R.L.; and Korshin, G.V., Peng, C.Y., Larsen, G. A. Young. 2010. *Assessment of Inorganics Accumulation in Drinking Water System Scales and Sediments*, Water Research Foundation, Denver, CO
- Great Lakes-Upper Mississippi River Board of State and Provincial Public Health and Environmental Managers. 2012. *Ten State Standards - Recommended Standards for Water Works*. Health Education Service, Albany, NY.
- Hill, A.S; Friedman, M.J; Reiber, S.H.; Korshin, G.V.; & Valentine, R.L. 2010. Behavior of Trace Inorganic Contaminants in Drinking Water Distribution Systems. *Journal AWWA*. Vol. 102, Issue 7, pp 107-118.
- Hoque, M. E., Hope, V. T., Scragg, R., & Kjellström, T. 2003. Children at risk of giardiasis in Auckland: a case-control analysis. *Epidemiology and Infection*, Vol. 131, Issue 1, pp. 655-662.
- HDR Engineering, Inc. 2001. *Chapter 8 – Source Water Development. Handbook of Public Water Systems*. John Wiley & Sons. New York, NY

- Kippin, S. J., J.R. Pet, J.S. Marshall, and J.M. Marshall. 2001. *Water Quality Impacts from Blending Multiple Water Types*, AWWA Research Foundation, Denver, CO.
- Kondakis XG, Makris N, Leotsinidis M, Prinou M, Papapetropoulos T. Possible health effects of high manganese concentration in drinking water. *Arch Environ Health*. 1989;44(3):175-178.
- Ljung K, Vahter M. Time to re-evaluate the guideline value for manganese in drinking water? *Environ Health Perspect*. 2007;115(11):1533-1538.
- Lye, D. J. 2002. Health risks associated with consumption of untreated water from household roof catchment systems. *Journal of the AWWA*, Vol. 38, Issue 5, pp. 1301-1306.
- Meuli, C., & Wehrle, K. 2001. Spring Catchment. *Series of Manuals on Drinking Water Supply, Vol. 4*. Swiss Centre for Development Cooperation in Technology. Niedermann AG St. Gallen, Switzerland.
- Oosterholt, F., Martijnse, G., Medema, G., & Van Der Kooij, D. 2007. Health risk assessment of nonpotable domestic water supplies in the Netherlands. *Journal of Water Supply: Research & Technology- AQUA*, Vol. 56, Issue 3, pp. 171-179.
- Peng, C. Y., Hill, A. S., Friedman, M. J., Valentine, R. L., Larson, G. S., Korshin, G. V. & Romero, A. M. 2012. Occurrence of Trace Inorganic Contaminants in Drinking Water Distribution Systems. *Journal AWWA*, Vol. 104. No. 3, pp. E181-E193.
- Prasifka, D.W. 1988. *Current Trends in Water Supply Planning: Issues, Concepts, and Risks*. Van Nostrand Reinhold Company, Inc. New York, NY.
- Seattle Public Utilities. 2012. *2013 Water System Plan. Volume 1. Chapter 2 – Water Resources*. Seattle Public Utilities, Seattle, WA
- Stokdyk, J.P., Spencer, S.K., Walsh, J.F., de Lambert, J.R., Firnstahl, A.D., Anderson, A.C., Rezania, L.I.W. and Borchardt, M.A. 2019. Cryptosporidium incidence and surface water influence of groundwater supplying public water systems in Minnesota, USA. *Environmental Science & Technology*, Vol. 53, No. 7, pp. 3391-3398.
- Taylor, J.S., J.D. Dietz, A.A. Randall, S.K. Hong, C.D. Norris, L.A. Mulford, J.M. Arevalo, S. Imran, M. Le Puil, S. Liu, I. Mutoti, J. Tang, W. Xiao, C. Cullen, R. Heavyside, A.

Mehta, M. Patel, F. Vasquez, and D. Webb. 2005. *Effects of Blending on Distribution System Water Quality*, AWWA Research Foundation, Denver, CO.

USEPA. 1991. *Manual of Small Public Water Supply Systems*, EPA 570/9-91-003.

WSDOH. 2003(a). *Potential GWI Sources – Determining Hydraulic Connection Through Water Quality Monitoring*, DOH 331-230, Washington State Department of Health, Olympia, WA.

WSDOH. 2003(b). *Potential GWI Sources – Microscopic Particulate Analysis*, DOH 331-231, Washington State Department of Health, Olympia, WA.

Acronym Key for Figure 5-1

CT Chlorine Concentration x Time

GW Groundwater

GWI Groundwater under the direct influence of surface water

MPA Microscopic Particulate Analysis

SW Surface water

**Figure 5-1 Evaluating Potential GWI Sources
WAC 246-290-640**

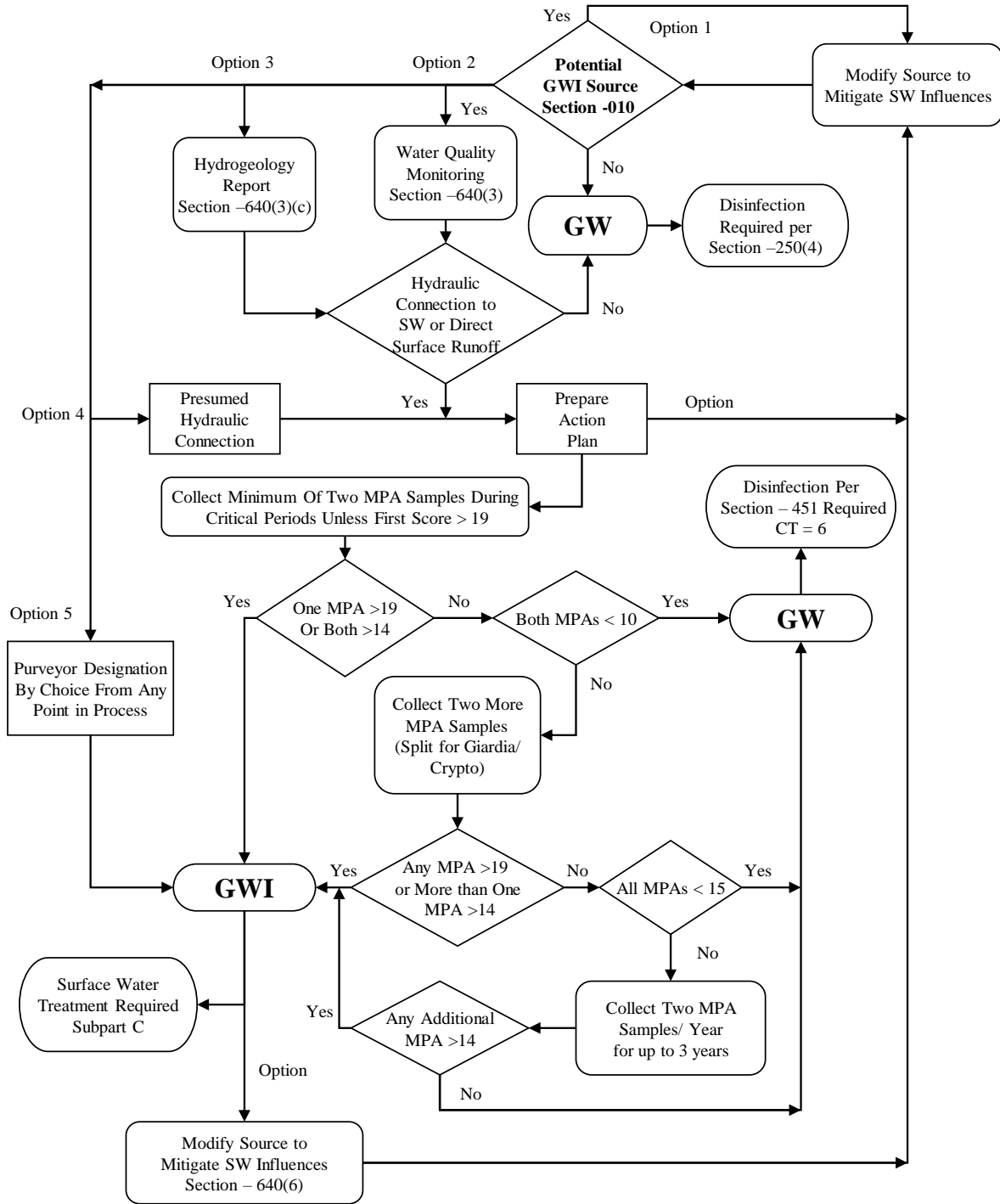

Chapter 6: Transmission and Distribution Main Design

6.0 Introduction

The proper design is vitally important to ensure that transmission and distribution mains reliably and efficiently convey safe drinking water to consumers. The essential design objectives for transmission and distribution systems are assessing hydraulic capacity under various flow conditions, facilitating best management practices in the operation of the piping system, and providing for the buried infrastructure's long-term physical resiliency.

Good design begins with good planning. Chapter 3 provides the basis for assessing water demands, and Chapter 4 describes the relationship between water infrastructure, water supply requirements, and water system capacity. Design engineers should integrate the transmission and distribution system design into the water system's overall design.

The design engineer's responsibility does not end with ensuring that the system will deliver the design flow to consumers at a useful pressure immediately after completing construction. Water systems will count on the continuous use of these new pipes for many decades. To promote such longevity, the design engineer should carefully consider selection of pipe material, size, location, and bedding; and evaluate the need for measures such as:

- Cathodic protection and polyethylene encasement to protect against corrosion.
- Vacuum relief and surge mitigation to protect against destructive surge forces.
- Restrained flexible joint pipe to provide resiliency against ground movement.
- Cross-connection control at point of service to high health hazard premises (see WAC 246-290-490).

Operators naturally seek to apply best management practices in the operation and maintenance of their distribution systems. That means pipeline design should facilitate operators' efforts, and include provisions for:

- Sampling stations at representative locations in the distribution system.
- Isolation valves and looped pipe to facilitate maintenance while minimizing service disruption.
- Flushing facilities and looped pipe needed to minimize water age and enable clearing the distribution system of settled particulates.

This chapter provides guidance on the size, materials, facility location, and other design factors required to achieve the design objectives listed above. The following definitions apply to this chapter:

Transmission mains convey water from the source, treatment, or storage facilities to the distribution system.

Distribution mains deliver water to individual customer service lines and provide water for fire protection through fire hydrants, if applicable.

6.1 Hydraulic Analysis

Design engineers **must** use a hydraulic analysis to size and evaluate a new or expanding distribution system (WAC 246-290-230(1)). All but the simplest distribution systems require a computer model for an accurate assessment. Hydraulic analyses take four steps (Cesario 1995; AWWA 2017):

1. **Collect data.** Hydraulic analysis data include physical data on pipes, pumps, reservoirs and valves, and operational data on flows and facility operations.
2. **Develop the model.** Use the data collected to develop a hydraulic model.
3. **Calibrate the model.** Calibration involves comparing model results with field observations. It is an essential step in developing a useful model (Walski 2000).
4. **Analyze the distribution system.** Use the calibrated model to analyze the distribution system to determine whether the existing system can meet minimum pressure requirements; if not, modify the pipe network to determine the improvements needed to meet minimum requirements. You should analyze distinct pressure zones separately.

Besides assessing a pipe network's capacity to deliver required flow-rates while meeting minimum and maximum pressure standards, use a hydraulic model to assess:

- Unidirectional flushing.
- Water quality in the distribution system.
- Water age.
- Water velocity.
- Hydraulic transients (water hammer).
- Reservoir siting and optimal geometry.

We **require** a detailed hydraulic analysis as part of a system's water system plan (WAC 246-290-100). We also may ask a water system for an analysis on an "as needed" basis

(to resolve an operating problem for example) (WAC 246-290-110(2) and (4)(f)). In all cases, systems **must** maintain minimum pressures (Chapter 246-290 WAC, Part 3).

6.1.1 Data Collection

Collect the following information to construct an initial model:

- Actual diameter and length of each pipe used in the model. See discussion of “skeletonization” below.
- Pipe type and age (to determine “C” roughness coefficient).
- Parameters that vary with time (pump rates, reservoir levels, discharge pressures, and demand patterns).
- Reservoir geometry and design levels (operating, equalizing, standby, fire suppression, and dead storage elevations) and whether a pressure zone is “open” or “closed” as defined in Chapter 8.
- Schematic of key distribution system elements, such as reservoirs and booster pump stations, to identify the operational scenarios that should be analyzed.
- Pump curves used in hydraulic simulations should represent the actual pump characteristics of the unit. Over time, pump impellers wear and can change the pump characteristics. Design engineers should determine whether the pump curves are still representative of the installed pumps or whether the curves need to be redrawn based on in-service pump flow and pressure testing.
- Operational rules for all major water system components. For example, get answers to the following questions. The answers are especially critical when running extended-period simulations:
 - Under what conditions do operators turn on a pump, open or close a control valve, or adjust a pressure-regulating valve?
 - Do reservoir level probes or pressure sensors control the pumps?
 - What are the corresponding on-off levels or pressures? Do pumping schedules change to minimize power costs?
 - Are all facilities available, or are some off-line for maintenance or repair?
- Node elevations taken from the best source possible (topographic survey, Google Earth). Use ground level elevations at nodes, rather than pipe elevations, because pressure measurements usually are taken close to ground level. In steep terrain, accurately locating the node is critical to an accurate elevation, and therefore to the hydraulic model results. A 10-foot variance from actual elevation will result in a 4-psi inaccuracy before any other modeling inaccuracies come into effect.

“Skeletonization” is the deliberate exclusion of distribution piping from the model. It simplifies model construction and speeds up the analysis. With increased computational power, skeletonized models are rarely developed (Speight et al. 2010). See detailed information on skeletonized model criteria in other guidelines (AWWA 2017, USEPA 2006). Design engineers should state whether they skeletonized the computer model, and if so provide justification and assessment of the skeletonized model in relation to the needed level of accuracy.

6.1.2 Hydraulic Model Development

Hydraulic model development involves both:

1. Defining the physical attributes that comprise the distribution system (sources, pipes, reservoirs, valves, and pump stations). See Section 6.1.1.
2. Identifying and allocating customer demand.

Allocating customer demand probably is the most important and difficult part of modeling (Speight et al. 2010). Typical data sources used to estimate current and future demand allocation include customer usage records, especially for large customers; distribution system leakage estimates; zoning information; projected land use; and fire flow requirements. From this information, it is possible to estimate maximum day demands, peak hour demands, and fire flow demands, and to allocate those demands to nodes within the model. When creating extended period simulation models, develop diurnal demand curves for each pressure zone.

6.1.3 Hydraulic Model Calibration

Calibration is an essential part of developing a useful hydraulic model. The calibration process involves comparing modeled or predicted results with field measurements. This process is necessary for the computer model to provide accurate and reliable results. Calibration often involves a trial and error process of adjusting the physical attributes and other information until there is satisfactory agreement between the field data and modeled results. Among reasons for discrepancies between field data and modeled results are:

- Erroneous model parameters (pipe roughness values and node demand distribution).
- Erroneous network data (pipe diameters and lengths).
- Incorrect network geometry (pipes connected to the wrong nodes).
- Errors in boundary conditions (incorrect pressure-regulating valve settings, unknown closed valves, tank water levels, and pump curves).

- Errors in historical operating records (pumps starting and stopping at incorrect times).
- Equipment measurement errors (improperly calibrated pressure gauges).
- Measurement error (reading the wrong values from measurement instruments).
- Field data collection error (moving too quickly from one field point to another without allowing the water system to stabilize between readings).

The level of effort needed to calibrate the model varies depending on the end use. The design engineer should identify the end use of the computer model's output and confirm that calibration and/or accuracy is sufficient for that use. A poorly calibrated model may result in inadequate fire flow, pressure problems, incorrect pipe sizing, or other issues with significant repercussions.

Design engineers may use various criteria to evaluate model accuracy. The most common are:

- **Absolute pressure difference.** Measured in psi.
- **Relative pressure difference.** Measured as the ratio of the absolute-pressure difference to the average-pressure difference across the water system.

Relative pressure difference is the preferred criterion. Simulations over extended periods involve comparing predicted to observed flow rates, pressures, and tank water levels.

It often takes a repetitive process to eliminate errors, especially when modeling larger water systems. It is most difficult to calibrate very old and corroded distribution systems, and water systems with little or no information.

There are no standard national or industry-adopted criteria for calibrating a hydraulic network model. Engineers can use the references and guidelines in Table 6-1 while calibrating hydraulic models. See the end of this chapter for recommended references on calibrating network distribution models (AWWA 2017; Bhave 1988; Cesario, 1995; Ormsbee and Lingireddy 1997; Speight et al. 2010; Walski 2000).

When calibrating extended-period simulation (EPS) models, the engineer should start with a steady-state hydraulic analysis for pipe roughness, elevations, and demand distribution (Walski et al. 2003). As part of developing an EPS model, engineers will need to develop a diurnal demand curve for the water system or pressure zone(s) they are analyzing. See Section 6.1.5 for information on EPS modeling.

Table 6-1: Industry Criteria for Calibrating Hydraulic Models

Accuracy of Readings	Accuracy of Flow Readings	Reference
Hydraulic grade line of model is within 5 to 10 ft. of field data. Water levels within 3 to 6 feet.	N/A	AWWA 2017
± 5% of maximum head loss for 85% of readings ± 7.5% of maximum head loss for 90% of readings	± 5%, where flow >10 % of the total demand	WRc 1989
Predict the hydraulic grade line to within 5 to 10 ft. at model calibration points during peak demands, such as fire flows	N/A	Walski et al. 2003

Note: 2.31 feet of head is equal to 1 psi.

Here are some data issues design engineers (“modelers”) should consider in calibrating hydraulic models:

1. Water systems that use a supervisory control and data acquisition (SCADA) system should confirm the calibration of devices used to measure tank levels, pressures, and flows for selected locations.
2. Without a SCADA system, water systems should manually track reservoir levels during flow and pressure tests, paying particular attention to the time they take each level reading.
3. Re-set demand allocation. For small water systems, it may be possible to gather source and individual meter readings before and after flow tests, and estimate the volume used during the tests. A reasonable way to check the model is to impose actual water system demand and flow-test data in a simulation, and then compare predicted residual pressures to those actually measured.
4. Because there may be uncertainty about pipe-roughness values in older distribution systems, we recommend that engineers adjust operational, consumption, and network data before they adjust pipe-roughness values. Adjust pipe roughness values for whole classes of pipe (e.g., change C for all cast iron pipe 40 years and older to 75). If known, use the effective pipe diameter (as opposed to the nominal diameter) in very tuberculated pipe. Pipe diameter can vary significantly in older pipe, even within the same pipe, and may be irregular and random due to build-up (tuberculation) or corrosion.

5. Pipe-roughness values significantly affect water system flows and pressures during peak hour demands and fire flows. Procedures for hydrant flow tests are in *Installation, Testing and Maintenance of Fire Hydrants* (AWWA 2006a). Criteria to identify deficiencies in pipe segments are in *Computer Modeling of Water Distribution Systems* (AWWA 2017). They include:
 - Velocities greater than 5 fps
 - Head losses greater than 10 feet per 1,000 feet
 - Large-diameter pipes (16 inches or more) with head losses greater than 3 feet per 1,000 feet

The accuracy of the calibrated model declines as changes occur in the actual water distribution network. The engineer should recalibrate the model when adding major new facilities to the network system, when peak hour demand or maximum daily demand exceeds that used in the model, or when operational procedures change significantly.

6.1.4 Hydraulic Model Analysis

Engineers can use the calibrated model to analyze the existing distribution system and various scenarios of proposed improvements to arrive at the most cost efficient, effective solution. The hydraulic analysis should clearly identify how the engineer developed and calibrated the model, and summarize the output. The following items should be in the hydraulic model discussion. These items also are in the hydraulic analysis checklist in Appendix A.3.4.

1. Develop a diagram showing all nodes (junctions) used and a corresponding written summary of assumed supply and demand flows for each condition that will be evaluated. Larger scale diagram sheets may be necessary to accurately show proper location and functions of all control valves and pump station facilities.
2. Explain all assumptions used for the model, including friction factors for the pipes and operating conditions of sources, storage reservoirs, booster pumps, and valves. For additions to existing water systems, compare computer model results to actual field measurements, and document that the model was calibrated accordingly.
3. Using a system contour map, identify the minimum pressure results found at the highest elevations and other critical areas in each pressure zone of the system under flow conditions found in item 5 (below).
4. Enter pump curves for the proposed source and booster pumps into the program to indicate how the system will respond to varying flow conditions.

5. Steady-state flow conditions **must** include each of the following (see WAC 246-290-230(5) and (6)):
 - a. PHD in each pressure zone and throughout the water system, under conditions that deplete all equalizing storage volume and assume all sources are operating. The resulting pressures **must** meet the requirements listed in Section 6.2.2.
 - b. Highest demand fire-suppression flows, such as commercial zones or industrial complexes (> 1,000 gpm fire flows, for example), during MDD. The design engineer **must** evaluate the water system and each pressure zone under conditions that deplete designed fire-suppression volume and equalizing storage. The resulting pressures must conform to Section 6.2.2 with respect to values and locations. Design engineers **must** evaluate water systems subject to the Water System Coordination Act assuming the largest capacity pump used to supply fire flow is out of service (WAC 246-293-640; WAC 246-293-660).

The distribution system design **must** provide adequate capacity under a variety of flow conditions (WAC 246-290-230). Water systems **must** operate their distribution systems so that 20 psi is available at the flowing hydrant(s) and positive pressure is maintained at all times under fire-flow conditions (WAC 246-290-420). That means design engineers should assess the flow available from a hydrant operating down to 20 psi on residual pressure elsewhere in the distribution system—even if that flow exceeds the local fire authority requirements..

A fire department may not know the effect it can have at distant points from the flowing hydrant when drafting it down to 20 psi. Design engineers should evaluate the potential that firefighting equipment may cause very low water system pressure at sites distant from the hydrant(s) in use. These low pressures may present a public health concern due to an increased risk for contamination from cross connections and pathogen intrusion. Options may include discussing water system constraints with fire protection authorities, color-coding fire hydrants to indicate limitations, placing orifice plates or other devices that restrict flow rates, following stringent disinfection O&M procedures after similar events, and informing users of precautions they can take to provide additional protection after a fire flow event.

6. Provide an explanatory narrative to accompany graphic figures. The narrative and figures should address:
 - a. Low and high-pressure areas in each pressure zone.

- b. Identify whether each zone has adequate equalizing and fire suppression storage.
- c. Identify capacity limitations within pressure zones. See Sections 4.4.4.1 and 4.5.4.1.
- d. Corrective measures and demonstration that corrective measures resolve deficiencies identified in the analysis.

6.1.5 Extended Period Simulation

Larger, more complex water systems should consider doing extended period simulation (EPS) (typically a multiple of 24 hours), using model conditions such as ADD, MDD, and a worst-case fire flow event with appropriate hourly peaking factors during the day. EPS also may apply to water systems with limited source capacity and greater reliance on storage facilities to meet demand. Water systems need EPS to understand the effects of changing water usage over time, cycles of draining and filling reservoirs, or the way pumps or valves respond to changes in demand.

As part of developing an EPS model, it is necessary to develop a diurnal demand curve for the water system or pressure zone being analyzed (Cesario 1995). The shape of the diurnal demand curve will vary between water systems and even between pressure zones within a water system. It isn't appropriate to take a diurnal demand curve from a textbook and apply it to an EPS model. Several publications explain how to develop a diurnal demand curve (AWWA 2017; Walski 2003).

6.1.6 Hydraulic Transients (Water Hammer)

Before completing the design or hydraulic assessment, the design engineer should be confident that the water system is safe from excessive water hammer conditions. Furthermore, transmission mains designed to operate at velocities greater than 10 feet per second (10 fps) **must** have a hydraulic transient analysis in conjunction with the hydraulic analysis described above (WAC 246-290-230(9)). Factors that make distribution systems vulnerable to hydraulic transients include:

- Long dead-end pipe segments.
- High velocity (greater than 5 ft./sec).
- Pipeline profiles with sharp changes in slope that create high points (AWWA 2017).
- Closed systems (Chapter 8 defines a closed system).

There are various computer programs available to the design engineer. Many programs designed to perform hydraulic analysis also do transient analyses. It is important to

select a model that matches the complexity of the facility. During facility start-up, the engineer should verify modeled results by gradually generating more and more severe conditions. This approach can show the water system works, as predicted, prior to generating the worst-case design conditions.

6.2 Sizing Pipelines

When sizing water system mains, engineers should consider many factors including pumping costs, future water system demands, land use, friction losses, flow velocities, and water quality. These factors interrelate, so designers should recognize the influence of each when selecting optimum piping arrangements. Engineers **must** design transmission lines, distribution facilities, water sources, pumping facilities and storage facilities so that, together, they meet minimum demand—including needed fire flow if applicable—and pressure requirements described in WAC 246-290-230.

6.2.1 Sizing Procedures

Many engineering textbooks, reference books, and design manuals include procedures for sizing water system distribution and transmission lines. There also are many common computer programs available to aid in the design of complex water systems.

6.2.2 Minimum Size

Engineers **must** use a hydraulic analysis to determine the minimum size of a transmission or distribution main (WAC 246-290-230(1) and (9)). The hydraulic analysis must address the parameters outlined in Section 6.1. In general, the main sizes need to provide the flow rates required to serve the anticipated land use near the water system as characterized in the water system plan and the local land use plan. All new and replaced distribution mains **must** be at least 6 inches in diameter, unless a hydraulic analysis justifies another size (WAC 246-290-230(2)).

Any pipeline designed to provide fire flow **must** be at least 6 inches in diameter (WAC 246-290-230(3)). Design engineers **must** consider at least two demand scenarios when using a hydraulic analysis to size water mains and other water system facilities (WAC 246-290-230(5) and (6)).

- **First**, the water system **must** be able to deliver the peak hourly demand at the required pressure of 30 psi at every existing and proposed service connection.
- **Second**, if the water system provides fire flow, the distribution pipelines **must** be able to deliver the maximum day demand (MDD) rate, in addition to the needed fire flow, at the required pressure of 20 psi throughout the distribution system.

Design of transmission mains **must** provide a minimum of 5 psi at the ground surface above the pipeline under maximum design flow conditions, except when the transmission main is located adjacent to a reservoir and the normal operation of the reservoir provides less than 5 psi (WAC 246-290-230(9)).

6.2.3 Peak Hourly Demand

Distribution pipelines **must** be able to deliver enough water to meet peak hourly demand (PHD) at 30 psi at every existing and proposed service (WAC 246-290-230(5)). PHD is the maximum rate of water use expected to occur in a defined service area, excluding fire flow. Unless there are accurate water demand records identifying PHD, the designer should use the equations in Chapter 3 to estimate PHD. If there is more than one pressure zone, the engineer **must** estimate PHD separately for each zone (WAC 246-290-235(5)).

6.2.4 Fire “Suppression” Flow

The local fire protection authority or county fire marshal usually determines minimum fire flow requirements (WAC 246-290-221(5)). The design engineer should always confirm the fire suppression requirements associated with a given water system design with the local fire protection authority. Where fire suppression is required, fire suppression flow plus maximum daily demand usually controls the size and layout of distribution systems. That is why it is so important to confirm the fire flow requirements.

Typically, the fire protection authority is the town or city fire chief, or county fire marshal in unincorporated areas. Some incorporated areas may contract for fire protection services with a district or the county. Local fire protection agencies may reference standards the Insurance Service Office (ISO) established to determine needed fire flow. As an example of these standards, ISO’s 2014 *Guide for Determination of Needed Fire Flow* standards for 1- and 2-family dwellings not exceeding 2 stories in height for a duration of 1 hour:

Distance Between Buildings	Needed Fire Flow
More than 30 feet	500 gpm
21 to 30 feet	750 gpm
11 to 20 feet	1,000 gpm
0 to 10 feet	1,500 gpm

The design engineer should discuss optimal fire hydrant spacing with the water system and local fire officials. See Appendix C to get contact information for the Office of the State Fire Marshall and Washington Surveying and Rating Bureau.

In designing a new water system, or expansion of service from an existing system, design engineers may wish to consult with the local fire protection authority and coordinate with local building officials on ways to minimize needed fire flow to accommodate any physical capacity constraints of the water system.

6.2.5 Minimum Distribution System Pressure

New water systems and additions to existing water systems **must** be able to provide PHD at no less than 30 psi at all service connections throughout the distribution system when all equalizing storage is depleted (WAC 246-290-230(5)). The water system **must** meet this minimum pressure at all existing and proposed service meters or along property lines adjacent to mains if no meters exist.

Many water systems recognize that the 30-psi standard is not optimal for modern appliances and sprinkler systems. Design engineers should check performance standards with the local water system, as local standards might be more stringent. At 10 gallons per minute, the friction loss through a typical $\frac{5}{8}$ -inch meter and $\frac{3}{4}$ -inch service line from water main to a home (assuming the total distance is 60 feet) is over 10 psi. Assuming 5 to 10 feet of elevation gain from the water main to the first floor of the home, only about half of the 30 psi at the water main is available for use inside the home.

During fire suppression events, the water system **must** be able to provide 20-psi minimum pressure at ground level at all points throughout the distribution system. The water system **must** be able to provide this minimum pressure under fire-flow conditions plus the MDD rate when all equalizing and fire-flow storage is depleted (WAC 246-290-230(6)).

We may approve water systems supplying existing customers, or designs for additions to existing water systems, to use individual-service booster pumps to provide minimum design pressure required under WAC 246-290-230 if the individual pumps are:

- Intended for interim use only.
- Managed and controlled by the water system, not the customer.

See Chapter 8 for specific design guidelines on individual-service booster pump stations.

6.2.6 Maximum Velocity

We recommend a maximum velocity of no more than 8-feet per second (fps) under PHD conditions, unless the pipe manufacturer specifies otherwise. Maximum velocities

greater than 8 fps may occur under fire-flow conditions, for short main sections, or piping in pump and valve station facilities. Excessive velocities may reduce pipe service life, cause excessive energy consumption, and increase the risk of damaging hydraulic transients. In addition, unplanned high velocity flow may scour interior pipe surfaces and cause water quality problems for consumers.

Engineers should conduct a hydraulic transient (water hammer) analysis for distribution piping designed to exceed 5 fps during PHD or fire-flow conditions (AWWA 2017), and **must** do so when a transmission main is designed to operate at 10 fps or more (WAC 246-290-230(9)). See Section 6.1.6 for a discussion on modeling transient conditions and Section 6.2.8 for surge control.

6.2.7 Excess Pressure

When designing a water main, it is important to consider the type of pipe used and the pressure needs of the water system. Excessive water system pressure can increase the risk of pipe failure and result in increased distribution system leakage. Working pressure in the distribution system should be limited to 80 psi unless the design engineer can justify the need for higher pressure (to reduce capital and/or pumping costs, increase fire flow reliability, or for other reasons), and verify that the pipe material is appropriate for the design working pressure. See Section 6.4.8 for recommendations on individual pressure-reducing valves.

6.2.8 Surge and Transient Control

Many factors influence hydraulic surges and transient conditions (water hammer), including main size, length, profile and construction materials. See Section 6.1.6 for an analysis of transient conditions. Engineers should base pipe pressure tests and thrust restraint on the maximum transient conditions, including an appropriate safety factor.

We recommend that water systems consider installing facilities that enable real-time monitoring of distribution system pressures to understand the occurrence of hydraulic transients and the associated risk of contamination through backsiphonage. Consider designing continuous pressure monitoring and SCADA reporting in booster pump stations, reservoir vaults, and PRV vaults.

There are many ways to provide surge control, including:

- Open surge tanks and pressurized surge tanks.
- Surge anticipator valves, vacuum relief valves, and regulated air release valves.
- Optimize the main size and alignment.

- Electric soft-start or -stop and variable speed drives for pumps.
- Electric interlocks to prevent more than one pump from starting at the same time.
- Slow opening and closing valves.
- Increase the polar moment of inertia of the rotating pump or motor assembly.
- Reduce flow velocity.

It may be necessary to combine methods. Engineers should take care to avoid a hydraulic-prevention strategy from causing a secondary water hammer equal to or worse than the original design.

Reliability of the surge protection facility is important. If appropriate, the design should provide redundancy for essential equipment such as vacuum relief valves. Surge tanks and similar components should have early warning alarms to notify operators. The design should not allow the pumping system to operate if the surge protection facilities are not operable.

6.2.9 Assessing Water Quality Effects on the Existing Distribution System

Changes in the physical or chemical environment in a distribution system may destabilize tubercles and introduce their chemical and biological communities into the water column. In Chapter 5 (Section 5.3) and Chapter 10 (Section 10.13) we describe the need to assess the effect of adding a new source or treatment process on distribution system water quality. The assessment should address concerns that chemical changes to the water in the distribution system (pH, dissolved oxygen, oxidation/reduction potential) may destabilize the tubercles, thus suspending corrosion byproducts, adsorbed metal ions, and biofilm or microbial contaminants.

For the same reasons, design engineers should assess the effect associated with replacement or addition of distribution system water mains on flow direction and velocity. These physical changes can shear tubercles from pipeline inner walls, resulting in suspension of chemical and biological contaminants into the distribution system. Water systems should clean existing pipe segments found to be vulnerable to tuberculation shearing before activating the new pipeline(s).

6.3 General Design Considerations for Mains

Design engineers should consider the location, depth, pipe material, and bedding from the perspective of future access, resiliency, and physical protection of the pipeline. These

basic design elements are especially important because buried pipelines are out of sight for their entire service life.

6.3.1 Installation

Design pipelines within a public corridor or established easement. Specify installation according to established standards such as Washington State Department of Transportation ([WSDOT/APWA Division 7](#)) and [AWWA](#). Use the information in and reference the latest edition of AWWA Standards such as C651 (Disinfection), C600 (DI pipe installation), C605 (PVC pipe installation), and ASTM standards such as F2620 (HDPE joining).

You also may find the following AWWA Manuals of Practice useful in preparing construction documents for the installation of transmission and distribution mains:

- AWWA M9: Concrete Pressure Pipe (AWWA 2008).
- AWWA M11: Steel Water Pipe – A Guide for Design and Installation (AWWA 2004).
- AWWA M23: PVC Pipe Design and Installation (AWWA 2002, AWWA 2005a).
- AWWA M41: Ductile-Iron Pipe and Fittings (AWWA 2009a, AWWA 2010).
- AWWA M55: PE Pipe Design and Installation (AWWA 2006b).

6.3.2 Depth of Pipe Burial

Design pipelines below the frost line measured in the most severe winters; otherwise, design freeze protection. When determining proper depth, engineers should evaluate temperature variations in the area, especially in Eastern Washington and mountainous areas. The minimum fill depth over the top of the pipe is usually 36 inches. The design engineer may justify another depth (for example, to avoid underground obstructions or rocky conditions).

If providing less than 36 inches of cover, engineers should consider and document the following in the project report:

- Pipe load and pipe strength.
- Freeze protection.
- Vulnerability to damage from future excavation.

6.3.3 Special Design Considerations

The design should protect pipes above ground from freezing (such as bridge crossings) and secure pipes at river crossings or subject to tidal action. The engineer should consider:

- **Pipe thrust restraints** whenever pipelines leave the soil.
- **Underground thrust blocking** whenever a pipe changes direction (such as a bend) or unbalanced thrust forces exist (pressure and momentum).

6.3.4 Separation from Nonpotable Conveyance Systems

Appropriate separation between potable and nonpotable pipelines protects public health and safety. Pipeline failure or leaks can result in pipeline contamination that jeopardize public health and safety. Nonpotable conveyance systems include piping that carries:

- Sanitary or industrial sewage
- Reclaimed water
- Irrigation supply from nonpotable sources
- Storm drains
- Petroleum products (oil, refined products)
- Natural gas

We do not consider a driveway culvert a nonpotable pipeline requiring special consideration.

Backflow of leaked content from a nonpotable conveyance system, or complete pipe failure of nonpotable piping can contaminate the potable water system. Pipeline designers can increase potable pipeline reliability by selecting proper pipe materials, wall thickness, pipe joint and thrust restraint systems, pipe bedding, and internal and external corrosion control, and adequate separation between pipelines.

Adequate separation minimizes incidental damage during the repair or replacement of potable water lines and pipelines. Adequate separation also ensures sufficient room to repair leaks and replace broken sections. Finally, separation reduces the potential for pipeline failure that a leak or failure of its neighboring pipeline could cause.

The following recommendations apply to pipelines of 24-inch diameter or less. Larger pipelines create more concerns and, therefore, require additional consideration.

Standard industry guidance calls for a minimum of 10-foot horizontal separation between the outer walls of potable and nonpotable pipelines in parallel installations, and a minimum of 18-inch vertical separation (potable water line above) between the invert of the potable water line and the crown of the nonpotable line at pipeline crossings (Ten State Standards, WAC 246-290-200).

We recognize that actual conditions can make it impossible to comply with these standards. If the design of a new or replacement water main cannot provide the standard 10-foot horizontal separation, design engineers should consult [Pipeline Separation Design and Installation Reference Guide](#) (WSDOE and DOH 2006). Provisions allow for parallel potable and nonpotable installations to be as close as 4-feet horizontally if they meet certain conditions. Design engineers should provide justification, and demonstrate that the conditions for a pipe separation less than 10-feet are met in the project report.

If the potable line is closer than 18 vertical inches from the nonpotable line at the point of crossing, or the potable line must cross under the nonpotable line, the potable line should be encased with ductile iron or steel pipe designed to withstand a minimum static pressure of 150 psi extending at least 10 feet to either side of the crossing. Additional measures may be necessary to mitigate the risk posed by crossing an existing nonpotable line, especially when it is located above the new water line.

If the water system receives permission to do so, mitigation of close parallel or crossing installations may be applied to the nonpotable line. This may include encasing the nonpotable pipe with pressure grouting, concrete, or controlled density fill. Surrounding nonpotable or potable pipes in concrete makes future repair or access extremely difficult. For this reason, we recommend the use of casing pipes instead. Designers should include project-specific information and justification, permission to work with the nonpotable pipe, and appropriate direction in the water system's pipe repair SOPs in the project report.

6.3.5 Separation from Other Potential Sources of Contamination

Design engineers should thoroughly evaluate water main installations on a case-by-case basis if they are near other potential sources of contamination. This may include a facility if a failure at the facility would subject the water in the main to toxic or pathogenic contamination. Other potential sources of contamination include storage ponds, land disposal sites for wastewater or industrial process water containing toxic materials or pathogenic organisms, and solid waste disposal sites.

Designers should not install water mains closer than 10 feet from a septic tank, drain field, or any other on-site wastewater treatment or disposal component. The measurement should be from the outer wall of the water main to the outer boundary of the drain field bed or exterior face of any other on-site component.

Design engineers and water systems should take precautions before selecting materials for a pipeline in an area with soils known or suspected to be contaminated with lower-molecular-weight organic solvents or petroleum products. Certain pipe materials, especially polyvinyl chloride (PVC), polyethylene (PE and HDPE), and polybutylene (PB), are susceptible to permeation by such contaminants (Holsen et al. 1991; Ong et al. 2008, Cheng et al. 2012). Elastomeric gaskets made of ethylene propylene diene monomer (EPDM) used to join ductile iron pipe are susceptible to permeation as well. However, nitrile-butadiene rubber (NBR) is resistant to permeation by organic solvents and petroleum products, so ductile iron pipe with these types of gaskets should be used if potential permeation is an issue (Cheng et al. 2012).

Designers and water systems should ask the pipe manufacturer about the risk of permeation of pipe walls and jointing material in such areas.

6.3.6 Pipe Materials

Various materials are available for distribution and transmission pipes. Engineers base their material selection on factors such as life-cycle cost (capital and maintenance), reliability, special design considerations, water system preference or familiarity, conformance with existing materials, and certification under ANSI/NSF Standard 61. The design engineer **must** use established standards, such as AWWA or the American Society for Testing and Materials (ASTM), when justifying the class of pipe selected (WAC 246-290-200(1)).

Any selected material that will have substantial contact with drinking water supplies **must** be certified to meet ANSI/NSF Standard 61 (WAC 246-290-220(1)). This applies to coatings, liners, or any joining materials used. "Substantial contact" means the potential for contaminants to enter the drinking water. Factors to consider are the total area of exposure, volume, length of time water is in contact with material, and level of public health risk.

6.3.7 External Corrosion Control

Engineers should consider protection from external corrosion in areas where corrosive soils are prevalent or when pipelines are exposed. This protection is especially true for

bridge crossings in salt-water (coastal) environments or other harsh environments. This protection also may be necessary in colder locations where salt is used to de-ice roads.

Engineers should also evaluate and, if appropriate, protect metal pipes from corrosion due to stray electrical currents in the soil. This usually occurs when metal pipes are near or cross:

- Major oil or natural gas pipelines protected by impressed current
- Light rail guideway

The AWWA Manual of Practice M27 on external corrosion control has detailed information on:

- Assessing the potential for corrosion of buried and exposed water mains.
- Protecting buried water mains.
- Selecting coating material for exposed pipes (AWWA 2014a).

6.3.8 Location of Pipes in Geologically Vulnerable Areas

Earthquakes and landslides have caused water mains to fail, leading to depressurization of distribution systems, boil water advisories, and significant service disruptions (Tanaka 1995; Ballantyne et al. 2009; WMD-EMD 2014). Although transitory seismic waves and strong ground shaking can cause some buried pipelines to fail, buried pipelines are at most risk when they are subjected to permanent ground displacements. The most common causes of permanent ground displacement are

- Liquefaction and lateral spread.
- Landslide.
- Settlement.
- Fault rupture.
- Subsidence or uplift.

To meet state and local requirements, engineers **must** address geologic risk (seismic and unstable slopes) when designing water systems (WAC 246-290-200), assessing existing water mains, and installing new water mains.

Engineers should prioritize making transmission and distribution systems that serve water for essential services earthquake-resilient, so that these pipelines remain functional after seismic events. Essential services include medical facilities; power plants; fuel refining, storage, and distribution facilities; food production, storage, and

distribution facilities; emergency response command and communication centers; and emergency shelters.

Engineers can reduce or mitigate seismic risk by:

- Identifying where pipeline alignments cross through regions of potential permanent ground displacement or strong ground shaking intensity.
- Using seismic-resistant pipe systems that can accommodate expected permanent ground displacements and strong ground shaking.
- Using flexible couplings that permit differential movement when pipelines attached to structures, such as tanks and vaults, move differentially with respect to the ground.
- Providing adequate support and bracing to structures that support above-ground pipelines.
- Installing redundant facilities and/or looped piping.
- Using appropriate valving to isolate vulnerable areas.
- Installing pipe within a reinforced pipe tunnel.
- Encasing with polyethylene.

The Washington State Department of Natural Resources has [geologic hazard maps](#) designers can use to identify seismic and other geologic hazards. Some pipes, such as butt-fused HDPE (AWWA 2015a), molecularly oriented PVC (AWWA 2009b), and seismic joint ductile iron pipe, are much less prone to failure in earthquakes and landslides (Water Supply Forum 2015). You also can consider using specialized, flexible expansion joints that can accommodate significant ground motion, especially near where water mains enter structures such as reservoirs and booster pump stations.

Design guidelines available from the American Lifelines Alliance can be useful in selecting and designing water mains in areas with significant geologic risk (ALA 2001; ALA 2005). In areas with the potential for permanent ground displacement or strong ground shaking, you may need to seek the services of a qualified geotechnical engineer or other professional qualified to assist in selecting materials and other design aspects.

6.3.9 Layout of Mains

Engineers should plan and design water mains in segmented grids and loops located in the established right-of-way or utility easement. Distribution mains should be looped, if possible, to avoid as many dead ends as possible. Looping may not always be practical due to topography, geology, pressure-zone boundaries, unavailable easements, or

locations of users. If water systems cannot avoid dead ends, they should provide blow-offs to allow adequate flushing of those mains. See Section 6.4.3.

6.3.10 Protection Against Cross-Connection

Water systems **must** protect their distribution systems from contamination through cross connections with any source of nonpotable liquid, solid, or gas that could contaminate the potable water supply by backflow (WAC 246-290-490). Design engineers should incorporate provisions that enable their water system clients to meet their regulatory obligations and to follow best management practices upon project completion. Backflow assemblies should be installed so that they can be readily tested, inspected, and maintained. Reduced pressure assemblies should not be installed in places that are vulnerable to flooding such as underground vaults. The following manuals provide detailed definitions, descriptions, and best practices for cross-connection control (CCC):

- *Manual of Cross-Connection Control (USC FCCCHR 2009)*. See Appendix C for USC Foundation for CCC contact information.
- *Cross Connection Control: Accepted Procedure and Practice Manual (PNWS-AWWA, 1996)*.
- [*Cross-Connection Control for Small Water Systems*](#) (WSDOH 2004).
- *Recommended Practice for Backflow Prevention and Cross-Connection Control* (AWWA 2015b).

It is important to determine CCC requirements during the planning phase of any water system project to avoid the expense and difficulty of retrofitting an existing facility or device to accept backflow protection. Engineers should consult with the water system's cross-connection control specialist (CCS) to be sure the design addresses the system's CCC requirements.

Basic CCC design considerations include:

1. Increased head loss. Backflow prevention assemblies increase head loss. Look for the head loss curve for a backflow prevention assembly in the manufacturers' assembly specifications.
2. Premises with high health-hazard cross connections listed in Table 9 of WAC 246-290-490(4). The design engineer should consult with the water system to determine whether it will connect a new water main to any existing Table 9 premises and, if so, consult with the CCS on the appropriate CCC strategy for each such prospective service connection.
3. Cross connection requirements within water treatment facilities (see Section 10.9).

4. Premises served by rainwater collection systems, private wells, reclaimed water, or any other nonpotable supply (see Section 5.10.1).
5. Overflow and drain pipes from storage tanks (see Section 7.4.3 and 7.4.4).
6. Pump-to-waste and air-vacuum relief valve discharge. Pump to waste **must** be fitted with an appropriate air gap (WAC 246-290-490).
7. Individual booster pumps. Design engineers must ensure that the facility design prevents individual booster pumps from negatively affecting distribution system water quality (see Section 8.4.1).

All backflow assemblies used to protect the public water system **must** be on the approved assemblies list developed by the USC Foundation for Cross-Connection Control and Hydraulic Research (WAC 246-290-490).

6.4 Appurtenant Design Considerations

The selection and location of pipeline appurtenances such as valves, instrumentation, flushing and sampling stations enable operators to optimally manage the distribution system and maximize consumer value. Engineers should consider the following as part of the overall distribution and transmission main appurtenant design.

The State Building Code Council (SBCC) administers our state's code adoption process. Contact information for SBCC is in Appendix C.

6.4.1 Valves

Designers should place enough valves to minimize the number of customers out of service when the water system needs to isolate a location for maintenance, repair, replacement, or additions. Spacing of distribution system isolation valves should be 800 feet or less (AWWA 2008) unless the grid geometry or low housing density justify greater spacing.

6.4.2 Vacuum Relief and Air Release Valves

The engineer **must** ensure the distribution system is protected from backflow contamination as a result of the intended operation of the vacuum relief or combination vacuum/air relief valve (WAC 246-290-490). The design should not provide a pathway for distribution system contamination; for example, through backsiphonage from an air-vacuum relief valve with a vent located inside an undrained pit or a pump-house drain line. The vent on these valves should be equipped with an appropriate air gap above the

highest possible water level. The design must not create pathways that could introduce contaminated water through backsiphonage.

High points of distribution or transmission lines where air can accumulate should have a way to vent the air. Venting options include an automatic air release valve, combination vacuum relief/air release valve, or manually operated devices. We recommend using a manual air relief valve or other manual means of venting air (fire hydrant, flushing hydrant, some types of service connections) wherever possible in lieu of an automatic valve (See Ten-State Standards).

Vacuum relief may be necessary at any point along a water pipeline where column separation could occur due to a negative pipeline transient pressure wave. See Sections 6.1.6 and 6.2.8. A sudden increase or decrease in flow may cause such events. The location where a vacuum relief valve is needed may be near or far from the cause of the transient wave (e.g., sudden booster pump station or source pump failure, rapidly closed valve, large and sudden pipeline break).

Vacuum relief may be necessary near a reservoir. To isolate the only reservoir serving a system or pressure zone, the water system may need a vacuum relief valve on the system side of the reservoir isolation valve (see Chapter 7). Water systems also may need vacuum relief to support vertical turbine pump operations. When a vertical turbine pump shuts down, water falls out of the pump column, and air is introduced on the pump side of the pump check valve to allow the pump column to return to atmospheric pressure.

If a valve is installed in a vault, the vault should be rated for appropriate vehicular loading whenever there is any possibility of traffic around the vault. The interior of the vault should provide at least a 2-foot clearance around the valve. The air inlet and discharge vents should be located outside the valve vault at least 18 inches above finished grade.

Weep holes located below grade in the vent discharge line should be avoided. Design options include locating both the valve and the discharge vent above grade in an insulated secure box. Extreme freezing installations may require vent inflow preventers to protect against backflow from flooded vaults.

Each vent should have a screened downward-facing vent opening (some valves may have multiple vents). Proper drainage away from the vent outlets is necessary. During valve operation some water discharge will occur through the vent. If the internal valve does not seat properly, there will be continuous water discharge.

6.4.3 Flushing Valves, Blow-offs and Hydrants

To allow sufficient flushing and proper disinfection of distribution mains, engineers should install blow-offs, automatic flushing stations, or hydrants at low points and dead-ends in the distribution system. They should be designed to achieve a minimum velocity of 3.0 fps in the main for scouring purposes. To meet these criteria, small water systems with larger pipes may need to consider design allowances that enable them to add temporary pumping or storage facilities.

6.4.4 Fire Hydrants

You should check with the local fire protection authority to make sure that the make and model of any proposed fire hydrant is acceptable; there are multiple types of dry barrel fire hydrants (AWWA 2005b; AWWA 2006a). The Water System Coordination Act defines standard fire hydrants (WAC 246-293-650(3)):

“All fire hydrants shall conform to American Water Works Association specifications for dry barrel fire hydrants. Each hydrant shall have at least two hose connections of 2½ inches diameter each and one pumper connection.”

New hydrants **must** be installed off mains at least 6-inches in diameter. The local fire protection authority **must** approve existing hydrants connected to a water main less than 6 inches, and the hydraulic analysis **must** demonstrate that the flow available at the hydrant meets the fire protection authority’s standards (WAC 246-290-230(4)). Residual pressure requirements described in WAC 246-290-230 (6) apply to hydrants installed on undersized water mains.

Other types of “hydrants” not designed to provide fire flows, such as flush valves, standpipes, blow-offs, or nonstandard, smaller volume hydrants without pumper ports may be placed on smaller mains (less than 6 inches in diameter).

Designers should provide all fire hydrants with their own auxiliary gate valve. Auxiliary gate valves are a safety item on hydrants, and most, if not all, water systems require them.

6.4.5 Sampling Stations

Every water system **must** develop and follow a coliform monitoring plan (WAC 246-290-300(3)(b)). See coliform monitoring plan guidance: [DOH 331-036](#) and [DOH 331-240](#). Design engineers should put sampling stations in locations where water systems can collect representative water quality samples from the distribution systems. We recommend the following sampling station features:

1. Use distribution piping, not household plumbing.
2. The sampling location should be in an active part of the distribution system.
3. The water system should have control (ownership) of the location or sample station.
4. The sample tap should be in a lockable enclosure and be otherwise protected from the weather and tampering.
5. A dedicated standpipe with a smooth-nosed sample tap is preferable.

To protect samples from potential contamination and false positives, engineers should not use stop-to-waste designs without first considering operations and maintenance, drainage, and security. Designs should provide adequate protection from freezing, such as using connections for a hand evacuation pump or using continuous flow sampling stations. See Section 5.2.6 for more information on desired sample tap attributes.

6.4.6 Yard Hydrants

Water systems may not install yard hydrants that drain the riser into the ground for any purpose without installing appropriate cross-connection control to protect the distribution system from contamination. The riser weep hole drain presents a risk of contamination to the distribution system through a cross connection with contaminated groundwater. If you choose to use a yard hydrant without cross-connection control protection, the *Uniform Plumbing Code* requires you to use a model that does not drain into the ground. We accept yard hydrants that conform to *American Society of Sanitary Engineering Standard 1057* (ASSE 2012) because they do not drain into the ground.

6.4.7 Angle, Curb or Meter Stops

Water systems should install separate angle, curb, or meter stops for each individual service connection. They allow water systems to close individual customer connections temporarily without interrupting service to other customers. We do not recommend supplying multiple water service connections from a single tap.

6.4.8 Individual Pressure-Reducing Valves

When a water system anticipates that pressure at the customers' point of use will exceed 80 psi, it should recommend that those customers install and maintain an individual pressure-reducing valve (PRV) as described in the *Uniform Plumbing Code* (IAPMO 2015). A water system should not install a PRV for an individual customer unless it has a written agreement with the customer showing who is responsible for required PRV maintenance, repair, or replacement. The design engineer should check for local ordinances or service agreements on PRV use.

6.4.9 Automatic Control Valves

The most common type of automatic control valve used in a distribution system is a pressure reducing valve. Other types include altitude valves (usually associated with an atmospheric reservoir) and combined pressure reducing or pressure sustaining valves (used when maintaining a predetermined minimum upstream pressure is more important than delivering all the flow needed downstream of the valve).

Engineers usually install these valves in undrained underground vaults. Therefore, they may be subject to flooding from high groundwater or storm water infiltration. Designers should be sure to protect installations that include any atmospheric vents installed as part of the valve's hydraulic control system from backsiphonage. See Section 6.4.2 for vent, vault, and drain standards.

6.5 Construction Documents for Pipelines

Design engineers **must** submit most construction documents—construction drawings and specifications intended for construction of water system infrastructure—to us for review and approval before construction begins (WAC 246-290-120). See Chapter 2. Construction documents include all the information the contractor needs to construct the improvements. Nothing of consequence should be left out of construction documents or left to the contractor's assumptions. We will not approve construction documents unless they provide enough detail to inform the contractor of his requirements with respect to:

- Approved materials.
- Sequence, location, and orientation of construction.
- Testing requirements.
- Submittal requirements for owner's approval.

The checklists in Appendix A.3.3 include specific guidance on information design engineers should provide in construction documents for pipelines

To ensure the finished pipeline operates successfully, it is important for the water system's representative to observe construction, including pipe and appurtenance handling; trench excavation, preparation, and backfilling; separation from other utilities; thrust restraint; disinfection; and testing. When the project is complete, a licensed professional engineer (usually the design engineer) **must** certify that construction conformed to approved construction documents, and the water system **must** submit the certification to DOH (see Section 6.6).

6.5.1 Construction Specifications for Pipelines

Construction specifications **must** meet commonly accepted technical standards, such as AWWA, [WSDOT/APWA](#), or equivalent (WAC 246-290-200(1)(d)). Attention to detail is important to ensure the identified specifications include all required information. The referenced specifications may require some case-by-case determinations. Specifications **must** thoroughly describe the materials, means, and methods for satisfying the requirements and conditions of the project (WAC 246-290-120(1)).

Water systems may include standard construction specifications in their water system plan or make them available as a separate document. The standard specifications should include materials, and construction or installation details the water system considers standard for construction and maintenance.

6.6 Placing a Water Main into Service

Before placing a new transmission or distribution main into service, the contractor **must** properly inspect, disinfect, and test it (WAC 246-290-120(4)). Engineers often use the [WSDOT/APWA standard specifications](#) (Division 7) and *AWWA C651 - Standard for Disinfecting Water Mains* to define pressure, leakage, and disinfection standard practices (WSDOT/APWA 2016; AWWA 2014b). The specific standards used for the project should clearly identify:

- Inspection and flushing requirements.
- Pressure and leakage testing methods.
- Disinfection and bacteriological testing methods.

A water main cannot be placed into service until it is flushed and properly disinfected, test results show that the water from it is safe to drink, and the engineer in charge of the project submits a [Construction Completion Form](#) to DOH (WAC 246-290-120(5); WAC 246-290-125(2)(b)). To ensure meaningful bacteriological results, collect coliform samples after you flush the water main and chlorine residuals return to background levels. For water systems with current, approved water system plans that include standard construction specifications for distribution mains, design engineers can use the [Construction Completion Form for Distribution Main Projects](#) (DOH 331-147) and keep it on file. For all other projects, design engineers **must** submit a complete [Construction Completion Form](#) (DOH 331-121) to DOH.

References

- ALA. 2001. *Seismic Fragility Formulations for Water Systems – Part 1 Guideline*. American Lifelines Alliance.
- ALA. 2005. *Seismic Guidelines for Water Pipelines*. American Lifelines Alliance.
- ASSE. 2012. *American Society of Sanitary Engineering Standard 1057 - Performance Requirements for Freeze Resistant Sanitary Yard Hydrants with Backflow Protection*. American Society of Sanitary Engineers. Mokena, IL.
- ASTM. 2013. *F2620 - Standard Practice for Heat Fusion Joining of Polyethylene Pipe and Fittings*. ASTM International (formerly American Society for Testing and Materials). West Conshohocken, PA
- AWWA. 2008. *Distribution System Requirements for Fire Protection*, 4th Edition. AWWA Manual M31. American Water Works Association, Denver, CO.
- AWWA. 2002. *PVC Pipe--Design and Installation*, 4th Edition: AWWA Manual M23. American Water Works Association, Denver, CO.
- AWWA. 2004. *Steel Pipe: A Guide for Design and Installation*, 4th Edition: AWWA Manual M11. American Water Works Association, Denver, CO.
- AWWA. 2005a. *C605 - AWWA Standard for Underground Installation of Polyvinyl Chloride (PVC) Pressure Pipe and Fittings for Water*. AWWA. Denver, CO.
- AWWA. 2005b. *C502 - AWWA Standard for Dry-Barrel Fire Hydrants*. AWWA. Denver, CO.
- AWWA. 2006a. *Installation, Field Testing, and Maintenance of Fire Hydrants*, 4th Edition: AWWA Manual M17. American Water Works Association, Denver, CO.
- AWWA. 2006b. *PE Pipe—Design and Installation*, 1st Edition: AWWA Manual M55. American Water Works Association, Denver, CO.
- AWWA. 2008. *Concrete Pressure Pipe*, 3rd Edition: AWWA Manual M9. American Water Works Association, Denver, CO.

- AWWA. 2009a. *Ductile-Iron Pipe and Fittings*, 3rd Edition: AWWA Manual M41. American Water Works Association, Denver, CO.
- AWWA. 2009b. *C909 - AWWA Standard for Molecularly Oriented Polyvinyl Chloride (PVCO) Pressure Pipe, 4 In. through 24 In. (100 mm through 600 mm) for Water, Wastewater, and Reclaimed Water Service*. AWWA. Denver, CO.
- AWWA. 2010. *C600 - AWWA Standard for Installation of Ductile Iron Water Mains and Their Appurtenances*. American Water Works Association, Denver, CO.
- AWWA. 2017. *Computer Modeling of Water Distribution Systems*, 4th Edition: AWWA Manual M32. American Water Works Association, Denver, CO.
- AWWA. 2014a. *External Corrosion Control for Infrastructure Stability*, 3rd Edition: AWWA Manual M27. American Water Works Association, Denver, CO.
- AWWA. 2014b. *C651 - AWWA Standard for Disinfecting Water Mains*. American Water Works Association, Denver, CO.
- AWWA. 2015a. *C906 - AWWA Standard for Polyethylene (PE) Pressure Pipe and Fittings, 4 In. (100 mm) Through 63 In. (1,600 mm), for Water Distribution and Transmission*. AWWA. Denver, CO.
- AWWA. 2015b. *Recommended Practice for Backflow Prevention and Cross-Connection Control*, 4th Edition: AWWA Manual M14. American Water Works Association, Denver, CO.
- Ballantyne, D., Seligson, H., Damianick, K, Heubach, W & W. Steenberg. 2009. *Performance of Water Supply Systems in the February 28, 2001 Nisqually Earthquake*. Water Research Foundation, Denver, CO.
- Bhave, P.R. 1988. "Calibrating Water Distribution Network Models," *Journal of Environmental Engineering*, Vol. 114, No. 1, February, pp. 120-136.
- Cesario, L. 1995. *Modeling, Analysis, and Design of Water Distribution Systems*. American Water Works Association, Denver, CO.
- Cheng, C. L., Gaunt, J. A., Mao, F., & Ong, S. K. 2012. "Permeation of gasoline through DI pipe gaskets in water mains". *Journal AWWA*, Vol. 104 No. 4, pp. E271-E281.

Holsen, T. M., J. K. Park, D. Jenkins, and R.E. Selleck. 1991, "Contamination of Potable Water by Permeation of Plastic Pipe," *Journal AWWA*, Vol. 83 No. 8, pp. 53-56.

IAPMO. 2015. *Uniform Plumbing Code*. International Association of Plumbing and Mechanical Officials. Ontario, CA.

Ong, S.K., J.A. Gaunt, F. Mao, and C-L Cheng, L. Esteve-Aglet, and C.R. Hurbugh. 2008. *Impact of hydrocarbons on PE/PVC pipes and pipe gaskets*. AWWA Research Foundation, Denver, CO.

Ormsbee, L.E. and Lingireddy, S. 1997. "Calibrating Hydraulic Network Models," *Journal AWWA*, Vol. 89, No. 2, pp. 42-50.

PNWS-AWWA. 1996. *Cross Connection Control: Accepted Procedure and Practice Manual*, 6th Edition. Pacific Northwest Section - American Water Works Association, Vancouver, WA.

Speight, V., N. Khanal, D. Savic, Z. Kapelan, P. Jonkergouw, M. Agbodo. 2010. *Guidelines for Developing, Calibrating, and Using Hydraulic Models*. Water Research Foundation, Denver, CO.

Tanaka. 1995. "Shaken Into Action" *Journal AWWA*, Vol. 87, No. 3, pp. 71-75.

USC FCCCHR. 2009. *Manual of Cross-Connection Control*, 10th Edition, University of Southern California - Foundation for Cross-Connection Control and Hydraulic Research, Los Angeles, CA.

USEPA. 2006. *Initial Distribution System Evaluation Guidance Manual for the Final Stage 2 Disinfectants and Disinfection Byproducts Rule*. Chapter 6: "System Specific Study Using a Distribution System Hydraulic Model." EPA 815-B-06-002. Washington, D.C.

Walski, T.M. 2000. "Model Calibration Data: The Good, the Bad, and the Useless," *Journal AWWA*, Vol. 92, No. 1, pp. 94-99.

Walski, T.M., D.V. Chase, D.A. Savic, W. Grayman, S. Beckwith, and E. Koelle. 2003. *Advanced Water Distribution Modeling and Management*, Haestad Methods, Inc., Waterbury, CT.

Water Research Centre (WRc). 1989. *Network Analysis – A Code of Practice*. WRc, Swindon, England.

Water Supply Forum. 2015. *Water Distribution System Seismic Vulnerability Assessment Workshop*. Bellevue, WA.

WMD-EMD. 2014. *Washington State Enhanced Mitigation Plan: Final Hazard Profile – Landslide*. Washington Military Department-Emergency Management Division, Tacoma, WA.

WSDOH. 2004. *Cross Connection Control for Small Water Systems*, DOH 331-234, Washington State Department of Health, Olympia, WA.

WSDOE and DOH. 2006. *Pipeline Separation Design and Installation Reference Guide*. WSDOE Pub. 06-10-029. Washington State Department of Ecology, Olympia, WA.

WSDOT and APWA. 2016. *Standard Specifications for Road, Bridge, and Municipal Construction – Division 7-09: Water Mains*. WSDOT Pub. M41-10. Washington State Department of Transportation, Olympia, WA.

Chapter 7: Reservoir Design and Storage Volume

7.0 Introduction

Adequate finished water storage provides multiple advantages to a water system. Storage can reduce excessive pump cycling; reduce sizing requirements for supply sources, treatment works, and transmission or distribution piping; and provide a reserve for fire-fighting and continued system pressure despite a temporary loss of supply. This chapter discusses water reservoirs that operate at atmospheric pressure. See Chapter 9 for guidance on pressurized storage.

The objective of reservoir design is to provide the water system with adequate and resilient water storage facilities that protect the quality of stored water. Public health protection requires thorough consideration of each reservoir design element, adhering to appropriate construction standards, and implementing best reservoir management and operating practices.

Historically, Washington's sanitary surveys revealed defects in reservoir design, construction, or maintenance that threaten the safety of the drinking water supply. Similar observations occurred throughout the country. In 2015, EPA indicated that it might amend the Revised Total Coliform Rule with specific inspection requirements for finished water storage facilities (USEPA 2015). At this time, the issue of regulating storage reservoir maintenance remains undecided, but the driving force behind it is clear: Poorly designed, constructed, and maintained reservoirs present a significant risk for distribution system contamination.

This chapter provides guidance for:

- Reservoir Sizing (Section 7.1).
- Geometry, elevation, and integration with existing and future facilities (Section 7.2).
- Location and site considerations (Section 7.3).
- Construction materials and design elements (Section 7.4).
- Operational constraints and considerations (Section 7.5).
- Reservoir water quality and sampling access (Section 7.6).
- Placing a reservoir into service (Section 7.7).

We do not intend to establish any particular reservoir design approach. See the references at the end of the chapter for more information on reservoir design (AWWA

2008, 2013; Ten State Standards 2012; Kirmeyer et al. 1999; Martel et al. 2002; Walski 2000).

7.1 Reservoir Sizing

To ensure the reservoir under design provides the level of service that the community expects over the lifetime of the facility, water systems **must** plan for population and land use changes (WAC 246-290-. Engineers design storage facilities to serve the needs of the community for a planned number of years, or to accommodate full water system build-out (for a particular subdivision, planned development, or as a condition of plat approval). The design life for a properly maintained concrete and steel reservoir is at least 50 years.

The following design guidance applies to the specific area(s) the reservoir under design will serve. This area may be the entire water system, where the designer intends to use one reservoir to serve all customers, or it may be a discrete pressure zone. For the purpose of this section, see Section 7.1.3 for definitions of “supply pumps,” “supply,” and “source.”

7.1.1 Storage Components

The design engineer **must** consider the five storage components discussed in Section 4.4.3 and listed below (WAC 246-290-235(3)):

1. Operational storage (OS).
2. Equalizing storage (ES).
3. Standby storage (SB).
4. Fire suppression storage (FSS), if applicable.
5. Dead storage (DS), if applicable.

Figure 7-1 illustrates and Table 7-1 describes a typical cross section of reservoir storage components.

7.1.1.1 Operational Storage

Operational storage (OS) supplies the water system while the pumps supplying the reservoir are in “off” status (WAC 246-290-010). This volume will vary according to the:

1. Sensitivity of the water level sensors controlling the supply pumps.
2. Geometry of the reservoir between the designated pump-off and pump-on water level set points.

Designers can use various water level sensors to signal pump-off and pump-on levels, including float switches, ultrasonic sensors, and pressure switches. Some level sensing devices can detect water level changes as small as a fraction of an inch. Others require more than a foot. Tank designers should account for the type of level sensor when determining the vertical dimension needed for proper operation of the device, reservoir, and supply pumps.

The OS volume should be sufficient to avoid source of supply pump cycling in excess of the pump motor manufacturer's recommendation. In general, design engineers should limit the supply pump motors to no more than six starts per hour unless the pump motor manufacturer permits more frequent cycling. To limit pump starts to no more than six per hour, OS volume can be conservatively calculated as the pump supply capacity (in gpm) times 2.5 minutes. Typically OS is substantially smaller than the remaining volume of the tank.

Operational storage volume does not apply to:

- Service capacity analysis (see Chapter 3).
- Water systems operating under a continuous supply mode (see Section 7.1.1.2).

When considering total storage volume needed, the design engineer should allow for seasonal changes in reservoir operational levels intended to reduce:

- Disinfection byproduct formation or to address other effects of extended water age. It may be necessary to adjust pump-on and pump-off levels and/or expand OS as a percentage of total reservoir operational volume.
- The potential for ice formation. It may be necessary to increase OS to improve circulation. An ice cap inside a reservoir can cause significant structural damage, damage to the internal coating system, and destruction of the level control system.

Figure 7-1: Reservoir Storage Components

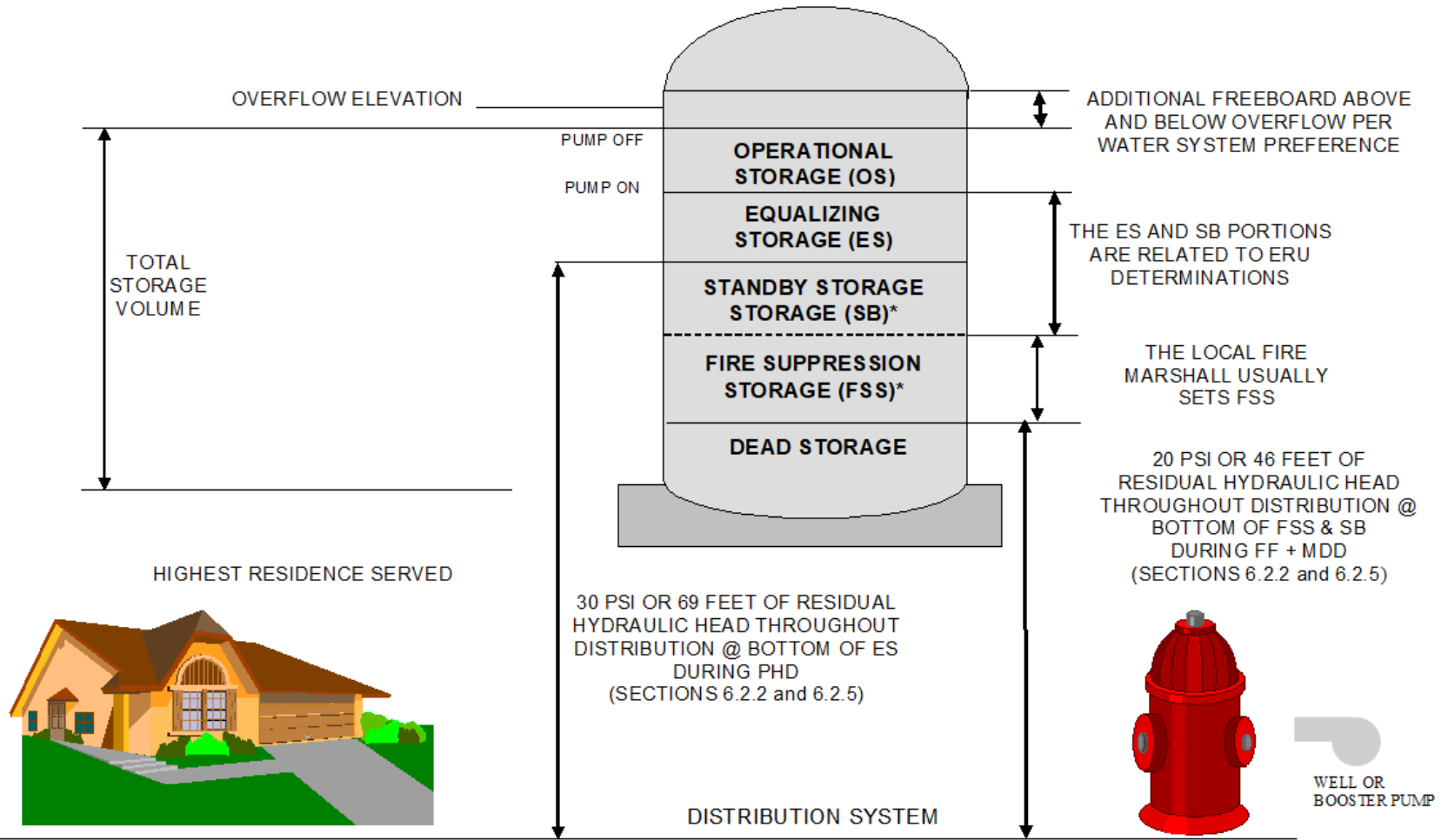

* WAC 246-290-235(4) allows consolidation of these components with approval of local fire protection authority. If consolidation ("nesting") is approved, apply whichever the greater of SB or FSS.

Table 7-1: Reservoir Storage Component Cross-Section Diagram

High Level Alarm. Overflow above **pump off** elevation

Pump(s) Off	<p>Operational Storage (OS) Component Not part of ES.</p> <p>Not applicable for continuous pumping systems.</p> <p>Minimum OS volume for pump protection can be conservatively calculated as the pump supply capacity (in gpm) times 2.5 minutes.</p>
Pump(s) On	OS = Operational storage component (gallons).
Maintain 30 psi (required)	<p>Equalizing Storage (ES) Component For call-on-demand:</p> <p>$ES = (PHD - Q_s)(150 \text{ min.})$, but in no case less than zero.</p> <p>ES = Equalizing storage component (gallons).</p> <p>PHD = Peak hourly demand (gpm).</p> <p>Q_s = Total of all permanent and seasonal sources (gpm).</p> <p>See Section 7.1.1.2 for sizing criteria for continuous pumping operations.</p>
Low Level Alarm	<p>Fire Suppression Storage (FSS) Component For Single Sources: $FSS = (FF)(t_m)$</p> <p>FSS = Fire suppression storage component (gallons).</p> <p>FF = Needed fire flow rate, expressed in gpm as specified by fire authority or the Coordination Act, whichever is greater.</p>
Maintain 20 psi (required)	t_m = Duration of FF rate, expressed in minutes as specified by fire authority.
Maintain 20 psi (recommended)	<p>Standby Storage (SB) Component $SB = (N)(SB_i)(T_d)$</p> <p>SB = Total standby storage component, or its equivalent, in gallons.</p> <p>N = Number of ERUs based on the ERU_{MDD} value</p> <p>SB_i = Locally adopted unit SB volume in gallons per day per ERU (number of ERUs based on the ERU_{MDD} value)</p> <p>T_d = Number of days selected to meet water system-determined standard of reliability</p> <p>We recommend a minimum SB volume of at least 200 gallons per ERU.</p>
	<p>Dead Storage (DS) Portion of a gravity reservoir that does not provide required minimum pressure.</p>

7.1.1.2 Equalizing Storage

The water system **must** provide equalizing storage (ES) when source pumping capacity cannot meet the peak hourly demand (WAC 246-290-235(4)). New water systems and additions to existing water systems **must** be able to provide PHD at no less than 30 psi at all service connections throughout the distribution system when all equalizing storage is depleted (WAC 246-290-230(5)). The water system **must** meet this minimum pressure at all existing and proposed service meters or along property lines adjacent to mains if no meters exist.

Many water systems recognize that the 30-psi standard is not optimal for modern appliances and sprinkler systems. Design engineers should check performance standards with the local water system, because local standards may be more stringent.

Several factors influence ES volume, including demand, source capacity, and the mode of supply. Two modes of supply operation are.

1. **Call-on-Demand (common):** Engineers often use this mode of operation to estimate ES. Call-on-demand operations use ES to supply the daily peak period of demand. Engineers should use Equation 7-1 to estimate minimum ES requirements unless actual water use records indicate a more applicable volume. Water systems with multiple sources may need to provide ES in excess of Equation 7-1 depending on the mode of operation.

Equation 7-1:

$$ES = (PHD - Q_s)(150 \text{ minutes}), \text{ but in no case less than zero}$$

Where:

- ES** = Equalizing storage component, in gallons
- PHD** = Peak hourly demand, in gpm, as defined in Chapter 3 of this manual
- Q_s** = Sum of all installed and active supply source capacities except emergency supply, in gpm. See Section 7.1.3 for definition of sources as it applies to this equation.

2. **Continuous Supply (unusual):** Engineers apply this approach to situations where reservoirs fill continuously over a period of time that does not necessarily coincide with the peak demand period, such as filling a reservoir during the night when the cost of energy can be lower. The volume of ES using this mode of operation can be significant because water systems use it to meet longer periods

of demand. ES sizing with continuous source pumping will require developing a maximum day demand (MDD) diurnal curve for the pressure zone(s) the reservoir supplies. Diurnal demand varies due to the pressure zone size, season, and type of demand (residential, commercial, industrial, and recreational). After developing the MDD diurnal curve, the design engineer can calculate the required ES by determining the difference between supply and demand. As a general guideline, the volume of ES needed using constant pumping is about 10 to 25 percent of the MDD (Walski 2000).

The engineer may eliminate ES only if the combined capacity of the supply sources meets or exceeds the PHD for the water system, or pressure zone, while providing 30-psi pressure at each existing and proposed service connection.

7.1.1.3 Standby Storage

Water systems intend SB volume to provide continued water supply during abnormal operating conditions, such as structural, electrical, mechanical, or treatment process failure; or source contamination (WAC 246-290-420). Engineers should use these standby storage guidelines for community water systems and noncommunity water systems, such as schools and health care facilities, where service disruptions would have significant effects on those served.

The degree to which engineers incorporate standby storage into reservoir design is a direct reflection of the consumers' expectations of water service during abnormal operating conditions. The water system governing body, representing the interests of the community, is in a position to determine the cost and benefit associated with providing a given level of reliability. Engineers should size SB volume based on locally adopted standards for water supply under emergency or abnormal operating conditions as outlined in Equation 7-2.

Equation 7-2:

$$SB = (N)(SB_i)(T_d)$$

Where:

- SB** = Total standby storage component, or its equivalent, in gallons.
- N** = Number of ERUs based on the ERU_{MDD} value.
- SB_i** = Locally adopted unit SB volume in gallons per day per ERU (number of ERUs based on the ERU_{MDD} value).

T_d = Number of days selected to meet water system-determined standard of reliability.

The lower elevation of the SB component should produce no less than 20 psi at all existing and proposed service connections throughout the distribution system during PHD conditions.

We recommend SB volume equal the MDD for the pressure zone(s) served (i.e., T_d = 1 day) and adjust SB volume based on factors listed below.

Water systems with a single source

Engineers should pay special attention to SB volume for water systems with only one source. Temporary loss of a water system's single source leaves only storage as a back-up supply. Design engineers should consider SB volume greater than MDD if the system's only source is vulnerable to flooding or other extreme weather events, extended power failures, or source treatment process failure; or if the transmission main from source to distribution is vulnerable to natural hazards (see Section 7.3.1). Design engineers considering the storage needs of water systems with only one source of supply should perform an all-hazards assessment. This assessment should evaluate the probability and duration of events that may lead to temporary loss of the system's only source of supply.

Water systems with multiple sources

It may be appropriate for design engineers to consider SB volume less than MDD if multiple sources provide mechanical, electrical, treatment, and transmission redundancy and resilience to a single contamination event. Section 7.1.3 lists what we consider to be continuously available sources of supply for reservoir design purposes.

Design engineers may justify a reduction of SB volume based on one or more of the following:

1. The water system and the local fire authority allow for nesting SB and FSS volumes, where the FSS volume is greater than the SB volume. See Section 7.1.1.4.
2. Two or more sources have permanent on-site auxiliary power that starts automatically when the primary power feed is disrupted. With the largest of these sources out of service, the remaining sources plus SB volume can maintain at least 20 psi throughout the distribution system under PHD conditions.
3. Two or more sources receive power from two electrical substations, so that failure of one substation will not interrupt the power supply to the source as

documented in writing by the power utility. With the largest of these sources out of service, the remaining sources plus SB volume can maintain at least 20 psi throughout the distribution system under PHD conditions.

4. Sources are located in different watersheds, wellhead protection areas, or aquifers.
5. Converting dead storage to standby storage by providing mechanically redundant booster pumping capacity with permanent on-site auxiliary power that starts automatically when the primary power feed is disrupted.

Even for pressure zones with multiple sources of supply and with other reliability measures as outlined above, we recommend SB volume of at least 200 gallons per ERU.

Water systems serving non-critical uses

If a loss of water-supply event occurs, certain types of noncommunity water systems could shut down without affecting public health and welfare. See Section 7.1.5 for additional design guidance for such systems.

7.1.1.4 Fire Suppression Storage

The local fire protection authority or county fire marshal determines a fire flow requirement for water systems. This fire suppression storage (FSS) level depends on the maximum flow *rate* and *duration*. Water systems the local fire authority require to provide fire flow **must** build and maintain facilities, including storage reservoirs, capable of meeting fire flow requirements while maintaining 20 psi pressure throughout the distribution system (WAC 246-290-221(5)).

For water systems supplied through gravity storage, the bottom of the FSS component **must** be at an elevation that produces no less than 20 psi at all points throughout the distribution system under the MDD rate plus fire flow conditions (WAC 246-290-230(6)).

Water systems with a single source

The minimum FSS volume for water systems served by a single source of supply is the product of the required flow rate (expressed in gpm) multiplied by the flow duration (expressed in minutes). See Equation 7-3.

Equation 7-3:

$$\text{FSS} = (\text{FF})(t_m)$$

Where:

FF = Required fire flow rate, expressed in gpm, as specified by fire protection authority

t_m = Duration of FF rate, expressed in minutes, as specified by fire protection authority

Water systems with multiple sources

Design engineers may justify a reduction of FSS volume based on meeting all of the following conditions:

1. Exclude the capacity of the largest producing supply source from the calculations.
2. Each source of supply (excluding the largest source) is:
 - a. Supplied by permanent on-site auxiliary power that starts automatically when the primary power feed is disrupted.
 - b. Capable of operating for the full duration of the maximum fire at the source's designated flow rate.
3. Maintain at least 20 psi under needed fire flow plus MDD conditions throughout the distribution system for the full duration of the maximum fire.
4. The engineer obtains the local fire protection authority's written consent for the design approach taken.

Consolidating Standby and Fire Suppression Storage (nesting)

Design engineers may consolidate or nest SB and FSS volumes with the larger of the two volumes being the minimum available, if the local fire protection authority does not require them to be additive (see WAC 246-290-235(4)). The reservoir project report must include the written consent of the local fire protection authority.

Stand Alone Fire Suppression Storage

Supply to a dedicated, stand-alone fire suppression storage tank **must** be fitted with an approved air gap (WAC 246-290-490). The rule considers all components downstream of the air gap nonpotable. Design engineers may not interconnect them with the potable water system without appropriate cross-connection control. Design engineers should consult a certified cross-connection control specialist. See Section 6.3.10.

7.1.1.5 Dead Storage

Dead storage (DS) is the volume of stored water not available to all consumers at the minimum design pressure (WAC 246-290-230(5) and (6)). The reservoir and water system capacity analysis should clearly identify the DS volume. Dead storage is never included in a capacity analysis. DS is always below the top of the outlet pipe silt stop. DS in pumped-storage reservoirs includes the volume below the top of the pump suction

pipe or the net positive suction head requirement of the withdrawal pumps, whichever is higher in elevation.

7.1.2 Storage Used for Treatment Purposes

Occasionally, water systems use storage near or adjacent to a source of supply for public health protection and treatment efficacy including:

- Disinfection contact time.
- Filter backwashing.
- Other treatment purposes.

As a result, water systems may need to maintain certain minimum water volumes in the reservoir for treatment to be effective. Engineers cannot use the minimum volumes required for treatment purposes in capacity determinations. These volumes are, in effect, dead storage. We recommend that treatment reservoirs (clearwells) operate independent of distribution storage.

When a design uses a reservoir for both distribution storage and disinfection contact time, engineers cannot use the OS and ES volumes to determine contact time because water systems routinely use those volumes on a daily basis. Design engineers should consider the risk that SB and FSS volumes will not be available for contact time. When a reservoir will provide both storage and disinfection contact time, the design should clearly identify and justify the basis for the volume of water used for disinfection contact time, and any associated operational or control requirements and constraints (e.g., level control and alarms).

7.1.3 Source Definition Used in Sizing New Reservoirs

Engineers may consider any source classified as “permanent” or “seasonal” when designing new reservoir facilities if the source is **continuously available** to the water system and meets, at a minimum, all primary drinking water standards (WAC 246-290-010, 222(3), and 420(2) and (5)).

“Continuously available to the system” means all of the following:

1. The source is equipped with functional pumping equipment (and treatment equipment, if required).
2. The system exercises the equipment regularly to ensure its integrity.
3. Water is available from the source year round.
4. The source activates automatically based on preset parameters (reservoir level, water system pressure, or other conditions).

For designing new reservoir facilities, we consider the following as sources:

1. Each pump in a booster pump station (pumps installed in parallel, not series) pumping into the zone that particular reservoir serves.
2. Each independent, parallel treatment train in a water treatment facility.
3. Each well, or well field comprised of wells, constructed according to the Minimum Standards for Construction and Maintenance of Wells (chapter 173-160 WAC) and capable of pumping concurrently as justified by actual pump test records.
4. Each pump installed in a large capacity, large diameter well if the water system can take each pump out of service without interrupting the operation of any other pump.
5. An emergency intertie, if it meets all the following conditions:
 - It is equipped with an automatic valve.
 - There is an intertie agreement that specifically includes provision of SB, FSS, or both.
 - The supplying and receiving distribution systems have sufficient hydraulic capacity to deliver the allocated flow at no less than the minimum pressure required by WAC 246-290-230. If the intertie requires booster-pumping facilities, then each pump installed in parallel constitutes a source.
6. A pressure reducing valve between pressure zones within the same water system if both of the following is affirmed:
 - Adequate volume is available in the upper zone's storage facilities.
 - The distribution system (from the upper zone through the PRV to the end use in the lower zone) has the hydraulic capacity to deliver the allocated flows to meet or augment peak hour flows or fire flows, at no less than the minimum pressure required by WAC 246-290-230.

Design engineers should use the actual installed capacity of the facilities and equipment when determining physical capacity based on storage requirements.

7.1.4 Storage for Consecutive Water Systems

A "consecutive water system" purchases some or all of its water supply from another regulated water system (see Section 5.9). A consecutive water system may use the storage available from the supplying water system to satisfy the requirements of Chapter 7 if it meets these conditions:

1. The wholesale water agreement between the supplying water system and the consecutive water system defines the quantity of ES, SB, and FSS the supplying water system specifically reserved for the consecutive water system. See Section 5.9.1.
2. The engineer can demonstrate that both the supplying and consecutive water systems can satisfy the hydraulic design criteria described in Sections 6.2.2 and 6.2.5.
3. The local fire protection authority approves the amount of FSS allocated for each system.

7.1.5 Storage for Noncommunity Water Systems

The storage volumes certain kinds of noncommunity water systems need may be significantly less than those for community water systems. These types of systems include:

- RV parks
- Campgrounds
- Fairgrounds
- Outdoor concert grounds
- Restaurants
- Noncritical commercial and institutional uses

For equalizing storage (ES), engineers should follow the approaches outlined in Section 7.1.1.2 to provide 30 psi during PHD under normal operating conditions. They should follow the guidance in Section 7.1.1 to provide operational storage (OS), fire suppression storage (FSS), and dead storage (DS).

If a source failure, power failure, or similar loss of water-supply event occurs, noncommunity water systems could shut down without affecting public health and welfare. As a result, we have no specific design guidelines for standby storage.

The source capacity for a public water system should be able to satisfy the maximum day demand (MDD) with no more than 20 hours of pumping. We strongly recommend against constructing and reserving finished water storage to compensate for supply capacity less than MDD. However, in rare cases applicable to transient noncommunity water systems with relatively few days of demand in excess of source capacity, it may be appropriate to use storage to meet MDD.

Design engineers should consider the effects of a relatively large storage volume held for a long period to compensate for supply capacity less than MDD. Such large volumes may lead to water quality issues associated with stagnant water including the loss of

chlorine residual, biological growth in the reservoir, and the formation of disinfection byproducts. See Section 7.6.

7.2 Geometry, Elevation, and Integration with Existing and Future Facilities

The operation of a finished water storage reservoir should be compatible with the unique features of the water system's sources, booster pumps, transmission and distribution piping, and service area topography. Incorrectly siting a reservoir may result in the full reservoir capacity being unavailable to the system (e.g., operating elevation too high so it doesn't fill, or too low and requiring an altitude valve to hydraulically isolate the tank from the water system).

Selecting tank geometry is also important to maintaining water quality. Improper tank geometry may prevent adequate mixing or promote thermal stratification (e.g., tanks that are much taller than they are wide with a single inlet or outlet demonstrate significant stratification. See Section 7.6.

7.2.1 Establishing Overflow Elevations

When establishing overflow elevations for reservoirs designed to provide gravity water service, consider:

1. Consistency with other facilities and plans

The tank overflow elevation should be consistent with other storage facilities the water system uses or plans to use. The design engineer should consider the overflow elevation of existing or proposed facilities at other nearby water systems if there are or might be gravity interties.

2. Consistency with pressure requirements and limits

The tank overflow elevation should be consistent with pressure requirements and pressure limitations within the existing and future water-service area. The design engineer should consult elevation data in addition to information received from the water system hydraulic analysis described in Section 6.1.

3. Consistency with source capacity

Design engineers should evaluate tank elevation and tank geometry with source equipment discharge-head characteristics to ensure sources meet our source capacity requirements.

4. Maintaining levels

Use altitude valves to prevent over-filling reservoirs constructed with different overflow elevations within the same pressure zone.

The overflow elevation should be far enough above the pump-off control level to remove any risk of regular overflow occurring during routine reservoir operations. Similarly, there should be sufficient “freeboard” space between the maximum water surface elevation during the design peak overflow and the wall-to-roof joint.

In very cold climates, ice formation may threaten reservoirs. The overflow should be far enough above the pump-off level so that ice cannot block its function, especially because ice formation might affect the pump-reservoir level control system. See Section 7.4.4 for additional overflow design guidance.

7.3 Location and Site Considerations

Deciding where to construct a new reservoir can be a difficult design consideration. Many competing factors and interests may come into play, with each influencing cost, operability, and maintainability. Some may even influence project feasibility. The project report should adequately discuss site considerations, including:

1. Parcel size sufficient to build and maintain the facility, and to construct future storage to meet projected growth, if needed.
2. Zoning compliance, building code compliance, and community acceptance.
3. Distance to the existing distribution and transmission system.
4. Integration or connectivity with existing SCADA system.
5. SEPA analysis (if over 0.5 million gallons).
6. Need for new distribution and transmission pipelines to meet pressure standards.
7. Existing ground-surface elevation and site drainage.
8. Site vehicle access.
9. Disposal of reservoir overflow.
10. Geotechnical engineering field investigations including:
 - a. Site drainage.
 - b. Foundation design requirements.
 - c. Soil type and soil-bearing strength.
 - d. Groundwater table elevation.
 - e. Soil stability, liquefaction, or slope failure analysis.
11. Availability of Power.

7.3.1 Natural Hazard Considerations

Natural hazards and disasters could damage reservoirs and may even cause catastrophic failure. Engineers should site reservoirs to minimize vulnerability to damage from natural disasters, such as:

- Avalanche
- Earthquake
- Flood
- Landslide
- Tree fall
- Tsunami
- Windstorm

To meet state and local requirements, engineers **must** address geologic risk (seismic and unstable slopes) when designing reservoirs (WAC 246-290-200). Engineers can use the Washington State Department of Natural Resources' (DNR) [geologic hazard maps](#) to identify seismic and other natural hazards. DNR contact information is in Appendix C.

Engineers should prioritize making reservoirs that serve water for essential services earthquake-resilient, so that they continue to serve water after seismic events. Engineers should follow the guidance in ASCE 7 while designing reservoirs for medical facilities; power plants; fuel refining, storage, and distribution facilities; food production, storage, and distribution facilities; emergency response command and communication centers; and emergency shelters.

Engineers can reduce or mitigate seismic risk by:

- Being aware of permanent ground displacement or intense ground shaking intensity (e.g., in fault zones) that may affect the reservoir and designing the reservoir to accommodate these hazards
- Installing valves water systems can use to prevent tanks and reservoirs from completely draining if there is excessive pipeline damage. You should coordinate isolation strategies that may limit or prevent water conveyance with the fire department.
- Using flexible couplings on pipelines connected between elements that may move differentially (such as buried piping connected to a tank or reservoir).

Various design guidelines highlight the multiple seismic vulnerabilities of reservoirs (ALA 2001; AWWA 2011b). In areas with the potential for significant ground motion, design

engineers may need to seek the services of a qualified geotechnical engineer or other professional qualified to assist in the design.

7.4 Construction Materials and Design Elements

The basic design concept (standpipe versus in-ground; vendor-purchased plastic product versus constructed in-place) and the materials the design engineer chooses to construct the reservoir directly affects the function, reliability, operability, and integrity of the facility. Engineers construct the vast majority of reservoirs are with reinforced concrete or steel. AWWA offers detailed standards for steel and reinforced concrete reservoirs:

- D-100: Welded Carbon Steel Tanks for Water Storage (AWWA 2011b)
- D-103: Factory-Coated Carbon Steel Tanks for Water Storage (AWWA 2009a)
- D-110: Wire- and Strand-Wound Circular Prestressed Concrete Water Tanks (AWWA 2004)
- D-115: Tendon-Prestressed Concrete Water Tanks (AWWA 2006)

A new reservoir is expensive to build and, depending on the type of reservoir, can be expensive to maintain. Water systems will count on the reservoir for reliable service for decades. Design engineers **must** identify operations and maintenance requirements and their associated cost over the life of the reservoir when evaluating design alternatives (WAC 246-290-110(4)). The least expensive alternative to construct may require a significant level of maintenance and a short asset life, resulting in the costliest alternative on a life-cycle cost basis.

The design engineer **must** evaluate the water system's technical, managerial, and financial capacity to properly operate and maintain the new reservoir (WAC 246-290-110(4)), and ensure the new reservoir continuously functions to provide safe and reliable drinking water to the public.

Certain reservoir design concepts, such as those listed below, pose specific contaminant risks including lack of resilience, construction gaps, bird and animal infestation, contamination by chemical wood preservatives, joint and seal failure, cracking, and embrittlement (e.g., ultraviolet light, heat or cold, or chemical degradation). In addition, these designs may not lend themselves to installing all the proper appurtenances necessary for effective reservoir operation and maintenance (see Section 7.4.2). We recommend against pursuing any of the following concepts for new reservoir designs.

- Wood stave tanks.

- Corrugated or other thin wall metal silos commonly used for grain storage.
- Concrete basin – wood truss roof tanks.
- Floating roof or covers.
- Precast panels used as finished storage roofing.
- Plastic or polyethylene tanks.
- Retrofitting existing reservoirs with plastic, interior liners.

Regardless of the construction material and design concept, all reservoir submittals **must** include the site-specific design information required in chapter 246-290 WAC, Part 3. Some circumstances justify the design engineer calling for the vendor or contractor to submit shop drawings for various construction and/or appurtenant details. If so, engineers **must** submit the vendor's or contractor's shop drawings to DOH for review and approval before the engineer and the water system approve them (WAC 246-290-120). Additional guidance on site-specific design requirements appears throughout this chapter.

7.4.1 Partially Buried and Underground Reservoirs

Special design considerations for partially buried and below-grade reservoirs improve water system reliability and prevent contamination of stored water. Engineers should consider backup power supplies, grading surrounding soils, and other design aspects described in the following sections.

The following recommendations apply to partially buried and underground reservoirs:

1. Locate outside the 100-year flood plain.
2. Water systems should grade the area to a distance of at least 50 feet surrounding a partially buried or below-grade reservoir to prevent standing water near the reservoir.
3. When the reservoir bottom is below the normal ground surface, it should be above the groundwater table. If this is not possible, special design considerations should include providing perimeter foundation drains to daylight and exterior tank sealants. These are necessary to keep groundwater from entering the tank and to protect the reservoir from potential flotation forces when the tank is empty.
4. Partially buried or underground reservoirs should be at least 50 feet from sanitary sewers, drains, standing water, and similar sources of possible contamination. If gravity sewers are within 50 feet of the reservoir, engineers should use the same

type of pipe used for water mains. These pipelines should be pressure tested according to AWWA or WSDOT/APWA standards for water mains.

5. Engineers should remove nearby trees and large vegetation to a distance of at least 50 feet for buried or partially buried concrete reservoirs to prevent root penetration. They also should secure easements to allow grounds maintenance and periodic tree removal.
6. The top of the reservoir should be at least 2 feet above normal ground surface, unless special design considerations address maintenance issues and prevent surface contamination.

7.4.2 Piping and Appurtenances - General

Engineers should design all reservoir appurtenances to be water tight and safe from freezing and ice damage, which will interfere with proper functioning (such as tank level controls, riser pipes, overflows, and atmospheric vents). Engineers **must** design these appurtenances to prevent entry by birds, animals, insects, excessive dust, and other potential sources of external contamination (WAC 246-290-235(1)).

Engineers should use seismically appropriate pipe materials and pipe joints for all pipes located within the reservoir, directly below the reservoir, and within 20 feet outside of the reservoir foundation. Engineers should evaluate these pipelines for corrosion potential and install corrosion mitigation, as appropriate. These pipelines will be difficult and expensive to repair or replace after the reservoir is in place. The location of the inlet and outlet pipes can also affect the quality of the stored water (See Section 7.6).

Design engineers should provide design information for the following reservoir appurtenances. See Appendix A.3.5 for reservoir design submittal checklist.

7.4.3 Reservoir Drains

Reservoir designs **must** include drain facilities that drain to daylight or an approved alternative that is adequate to prevent cross-connection contamination (WAC 246-290-235(1)). The facility should be able to drain the full contents of the tank without water entering the distribution system or causing erosion at the drainage outlet. Any connection to storm sewers or sanitary sewers must have a properly designed air gap or other feature to prevent cross contamination. Drain lines may discharge directly to a dedicated dry well if the drywell design and construction protect against backflow into the reservoir or distribution system.

Other design considerations:

- Drainage discharge should not threaten the integrity of the reservoir foundation.

- If the topography makes a drain to daylight unrealistic, the reservoir design should include another way to empty the reservoir completely, such as a sump pump.
- The reservoir drain should be separate from the outlet pipe to minimize the risk of a cross connection and prevent sediment from entering the distribution system.
- Establish an easement for drainage path (if applicable).

7.4.4 Reservoir Overflows

The reservoir overflow must be capable of discharging the full inlet supply potential without surcharging the reservoir roof (see Section 7.2.1). The following factors will determine the height that water reaches above the overflow invert or weir elevation:

- The design overflow rate.
- Size, location, and configuration of the reservoir overflow inlet.
- Overflow pipe diameter, length, and slope.
- Overflow outlet facilities.

Every reservoir design **must** include an overflow pipe with atmospheric discharge and suitable means to prevent cross-connection contamination (WAC 246-290-235(1)). Poorly protected and maintained overflow pipes are often a route for contamination of reservoirs (AWWA and EES, Inc. 2002; NRC 2005). Key design features to minimize the risk that birds, insects, and other sources of contaminants enter reservoirs through overflow pipes:

- 1. Properly screened or otherwise secured.** Acceptable design approaches include covering the overflow outlet with a 4-mesh corrosion-resistant screen or a securely closing mechanical device such a duckbill valve, or both. To provide structural strength to the screen, we recommend the 4-mesh screen material be at least 0.047 inches in diameter and constructed of stainless steel. In addition to preventing animals from entering the reservoir, overflow design must protect against vandalism, hydraulic restrictions on mechanical devices such as duckbill valves, clogging by debris and ice, and the force of hydraulic loads on the screening or mechanical device an overflow event might cause.
- 2. Easy to observe and maintain.** Overflow lines should extend downward to an elevation of 12 to 24 inches above ground level and discharge into a splash plate, rocked area, or suitably above the grate of a catch basin.

- 3. Protected against cross connections.** Any connection to a storm drain or sanitary sewer **must** include an air gap or other feature to prevent cross contamination (WAC 246-290-235(1)).

Other design considerations:

- Overflow discharge should not threaten the integrity of the reservoir foundation.
- The overflow and reservoir drain may share a single discharge.
- Establish an easement for overflow drainage path (if applicable).

7.4.5 Reservoir Atmospheric Vents

Every reservoir design **must** include an atmospheric vent (WAC 246-290-235(1)). An overflow may not serve as an atmospheric vent. Poorly designed and maintained vents and screens are often a route for contamination of reservoirs (AWWA and EES, Inc. 2002; NRC 2005). Key design features for reservoir vents include:

1. Proper screening to prevent entry of contaminants.
2. Properly secured and sealed to the structure to prevent entry of contaminants.
3. Properly hooded to prevent entry of contaminants.
4. Easy to observe and maintain.
5. Maintain acceptable internal tank pressure under all possible operating conditions.

Properly screened

Acceptable design approaches include covering the screened area with a 4-mesh corrosion-resistant screen backed with a 24-mesh corrosion-resistant insect screen, or approved equal. To provide structural strength to the screen, we recommend the 4-mesh screen material be at least 0.047 inches in diameter and constructed of stainless steel or other noncorrodible metal.

Properly secured

The vent-roof connection and the vent structure itself should be strong enough to withstand the design wind speed for which the overall reservoir structure was designed. We recommend connecting the vent to the roof with a bolted pipe flange or welded saddle. Vent openings should never be used to facilitate water level measurement or be installed as an integral part of the roof hatch access structure.

Properly hooded

Vent design **must** prevent the entry of precipitation that contacts any surface that may be contaminated (e.g., bird feces) (WAC 246-290-235). Examples of unacceptable vent designs include those with the potential for allowing:

- Animals to nest directly on the vent screen.
- Rain splatter off the roof to enter the reservoir vent (e.g., roof vent with screened opening only a few inches above the roof without an adequate “hood” over the vented area).
- Roof run-off to enter the vent (e.g., screened opening at the roofline).
- Rain falling through the vent opening (e.g., turbine roof ventilators).

Eliminating the risk of precipitation entering the reservoir may provide some basic protection against vandalism. Certain reservoir vent designs provide strong barriers against vandalism, such as those with extensive and resilient hoods, multiple screens, and rigid structural design.

Easy to observe, access, and maintain

Screened openings should be observable, to confirm the integrity of the screen fully protecting the reservoir from contamination. To reduce maintenance, all vent components should be constructed of corrosion-resistant materials.

Maintain acceptable internal tank pressure

In addition to preventing contamination, the screened vent opening should be high enough above the roof to prevent blockage by accumulated ice and snow. We recommend every part of the screened vent opening be at least 24 inches above the roof (or covering earth) for partially buried and underground reservoirs, and at least 12 inches above the roof for an elevated tank with controlled access.

The design engineer should ensure enough vent capacity to limit the pressure drop (during tank draw) and pressure increase (during tank fill) under all operating conditions so that internal tank pressure remains within the manufacturer’s design limits. Large welded steel tanks are most vulnerable to structural damage from inadequate venting. But the design engineer **must** ensure all tank types, including rigid bolted steel, fiberglass, and concrete tanks have adequate ventilation under fill and draw conditions to avoid the risk of drawing in groundwater or stagnant roof water (WAC 246-290-235(1)).

The design engineer should obtain from the vent manufacturer a flow rate versus pressure drop (in inches of water) curve. This curve should be used to estimate the pressure drop at the worst case outflow condition (e.g., broken transmission main). The resulting drop in internal pressure should be within the design limits for the tank. If the tank manufacturer did not specify design limits (e.g., cast-in-place concrete reservoir),

we recommend a design pressure drop of no more than one inch of water (0.033 psi or about 5 psf).

Designers should provide a pressure-vacuum-screened vent or a separate pressure-vacuum-relief mechanism on tanks vulnerable to structural damage (e.g., steel tanks) in case snow, ice, frost, or another substance blocks the screen (AWWA, 2011b).

See *Sanitary Protection of Reservoirs - Vents* [DOH 331-250](#) for guidance on reservoir vents.

7.4.6 Access Hatches

All reservoirs **must** be equipped with a weather-tight hatch sized for human entry (WAC 246-290-235(1)(c)). Except for reservoirs that can be isolated from the distribution system without disrupting consumer service, the access hatch should be installed on the roof, thus allowing access while the tank remains in service. A roof hatch should be framed at least four inches above the surface of the roof at the opening, fitted with a solid weather-tight cover that overlaps the frame opening and extends down around the frame at least two inches, hinged on one side, and lockable from the side (not top) of the cover. There should be a durable gasket at the point of contact between the hatch cover and hatch frame.

For partially buried and underground reservoirs, the roof access hatch should be constructed at least 24 inches above the top of the roof or covering earth, whichever is higher. See [Ten State Standards](#), WAC 246-290-200.

We caution design engineers on the use of “gutter” style hatches. Typically constructed on a raised concrete curb, these hatches have an internal gutter beneath the cover that drains to an external outlet. The cover system itself is not waterproof. A noncorrodible screen should cover the drain outlet, to prevent animals or insects from entering the internal gutter. The gutter and screen should be cleaned on a regular basis; otherwise drainage may back up into the internal gutter and spill over into the reservoir. These types of hatches **must** be well constructed and maintained (i.e., include maintenance in reservoir standard operating procedures) to minimize the risk of contamination (WAC 46-290-235(1)).

See *Sanitary Protection of Reservoirs - Hatches* [DOH 331-249](#) for guidance on reservoir hatches.

7.4.7 Roof Drainage

The reservoir roof should be well drained. The reservoir roof should slope at least 2 percent ($\frac{1}{4}$ -vertical-inch per horizontal foot). To avoid possible contamination, downspout pipes **must not** enter or pass through the reservoir (WAC 246-290-490).

7.4.8 Reservoir Security

Design engineers should apply a multilayered strategy to protect reservoirs and other water system facilities:

1. **Deter:** Perimeter fencing is a common means of deterrence. If the reservoir site looks hard to break into, most trespassers will move on to a more easily accessible site.
2. **Detect:** Video surveillance, intrusion monitors, and other sensors signal unauthorized access to a facility.
3. **Delay:** Layers of gates, locks, and perimeter fencing make it more difficult for an unauthorized person to gain entrance.
4. **Respond:** Detection and delay technologies should communicate with each other, and the responders. Security guards and local law enforcement often **respond** to unauthorized intrusions. It can help to have a solid relationship with responders, so they understand the importance of water system facilities.

Detailed guidelines on specific physical security features are available (ASCE 2004; ASCE 2006; Oregon Health Authority 2009). These guidance documents provide design recommendations to improve security at reservoirs and other water system facilities.

7.5 Operational Constraints and Considerations

Every new reservoir design should meet all applicable Occupational Safety and Health Act (OSHA) and Washington Industrial Safety and Health Act (WISHA) requirements, especially fall protection issues such as ladders, guardrails, and safety devices. Engineers also should consider the following reservoir construction and operational issues:

1. Disposal of chlorinated water after construction and disinfection.
2. Disposal of tank drain-line outflow and tank overflow stream.
3. Effect on water system operation when the new reservoir is taken off-line for maintenance or cleaning.

The Department of Labor and Industries (L&I) is the state agency that implements WISHA workplace safety standards. L&I contact information is in Appendix C.

7.5.1 Reservoir Valves

The reservoir design **must** include a way to isolate the tank for maintenance (WAC 246-290-235(1)). Engineers can meet this requirement by providing an isolation valve(s) on the reservoir inlet and outlet piping. In addition, there **must** be a combination air-release/vacuum-relief valve on the distribution side of the outlet piping isolation valve if there is no other atmospheric reservoir in the pressure zone to keep negative pressure from building in the distribution system (WAC 246-290-490) when the outlet valve is closed.

7.5.2 Reservoir Level Control

All new reservoirs should have a control system to maintain reservoir water levels within a preset operating range (OS). Design engineers should include the normal high- and low-water surface elevations that define this operating range in the design. The water system should install a high- and low-level alarm system to notify operation personnel directly.

Cable-supported float switches are vulnerable to ice damage, which can render them inoperable. Where potential freezing conditions exist, design engineers should evaluate alternate ways to control and monitor the tank level.

7.5.3 Backup Power Facilities

We recommend that water systems operating pumped storage reservoirs (reservoirs that can only supply a distribution system in whole or in part through a booster pump station) have onsite backup power facilities. See Chapter 8 for booster-pump design guidelines. We recommend backup power facilities that start through an automatic transfer switch if a power supply interruption occurs. A manual transfer may be sufficient if it can occur within a reasonable time according to established operating procedures. Maintaining pressurized conditions in the distribution system during a power outage minimizes the risk of backflow or cross connection contamination.

7.6 Reservoir Water Quality and Sampling Access

Long detention times and inadequate mixing can degrade water quality in reservoirs. Stagnant conditions provide an opportunity for chemical and microbial contamination of the stored water. Therefore, engineers **must** design distribution reservoirs to maintain water circulation, prevent stagnation and, in some cases, provide disinfection contact time (WAC 246-290-235(1)).

For reservoirs with a nominal residence time of 3 to 5 days during the summer, design engineers should conduct a mixing and water age analysis of the proposed reservoir

design, such as computational fluid dynamic modeling. Such modeling will guide on the design of inlet-outlet piping and valves, as well as setting operational levels. Chemical contamination also can occur in newly constructed reservoirs and those with protective coatings. See Appendix G.

Reservoirs **must** include access for water quality monitoring (WAC 246-290-235(1)(c)). At a minimum, this access should include a smooth-nosed sample tap on the reservoir side of the reservoir isolation valve(s). This valve will facilitate sample collection after construction and maintenance, and as part of a system assessment after detecting contaminants or vandalism. In addition, design engineers should consider providing the means to conduct water quality monitoring at the inlet and within the reservoir, including on-line measurement of chlorine residual, pH, and temperature, where feasible. Temperature probes and piping to collect samples at various reservoir depths provide operational capacity to monitor reservoir water quality (Friedman et al. 2005).

We recommend installing a sample tap in the valve vault on the tank side of the isolation valve.

7.6.1 Water Circulation and Stagnation

Poor water circulation and long detention times in reservoirs can lead to loss of disinfectant residual, microbial growth, sediment accumulation, formation of disinfection byproducts, taste and odor problems, and other water quality issues (AWWA and EES 2002; NRC 2005). A properly designed reservoir can minimize the potential for these problems.

Engineers should evaluate the following design features to improve reservoir water quality:

- 1. Orient inlet and outlet to promote mixing.** Poorly mixed reservoirs can lead to stagnant zones where the water age exceeds the average water age in the facility. A properly designed inlet promotes mixing. Water entering the reservoir can create a jet that entrains ambient water effectively mixing the reservoir (Grayman and Kirmeyer 2000). For effective mixing, the inlet flow must be turbulent and have a long enough path for mixing to develop. You should consider the ability to provide long fill and draw cycles, and thus promote reservoir mixing, as part of the design process.

Reservoirs that float on the water system, especially those with single inlet-outlet designs, probably won't have sufficient inflow to mix the reservoir adequately. Special valve arrangements, using one or more check valves on a single inlet-

outlet pipe, can be used to promote mixing. Some reservoirs may need specialty mixers to prevent stagnation.

2. **Minimize temperature differences in the reservoir.** Temperature differences as small as 1°C can cause thermal stratification, especially in tall tanks with large diameter inlets located near the bottom. To decrease the potential for thermal stratification, locate the inlet off the bottom of the reservoir and increase the inlet momentum (defined as velocity times flow rate). To increase inlet momentum, decrease the diameter of the inlet pipe. Longer fill cycles also promote mixing by increasing the time for circulation patterns to develop.
3. **Increase the frequency of reservoir turnover.** Although not an absolute standard for stored water, there is a high risk for water quality problems to develop when reservoir turnover time exceeds five days, especially in warmer months. As a starting point, complete turnover of reservoir water should occur at least every three to five days (Kirmeyer et al. 1999).
4. **Site reservoir to promote turnover.** Reservoirs located at the edge of a pressure zone, or beyond, have longer detention times than those within the pressure zone (Edwards and Maher 2008). Distribution system models that evaluate water age and water system hydraulics can be useful in evaluating reservoir sites.
5. **Evaluate other engineering considerations.** Temperature gradients in the stored water cause thermal stratification. For this reason, some water systems apply light or reflective protective coatings to the tops of their reservoirs. Tall, narrow standpipes are more prone to thermal stratification than reservoirs with roughly equal height and diameter (Grayman and Kirmeyer 2000).

7.6.2 Tank Materials in Contact with Potable Water

All additives, coatings and compounds that will substantially contact drinking water, such as those listed below, **must** have ANSI/NSF Standard 61 certification (WAC 246-290-220). Contractors should apply these materials carefully, according to the manufacturer's recommendations. To avoid unnecessary public health concerns and consumer complaints on aesthetic qualities, the design engineer should address the following concerns:

1. For concrete tanks, use appropriate form-release agents, concrete surface sealants, and admixtures. See Appendix G for guidance on water quality concerns associated with concrete in contact with potable water.
2. For steel tanks, consider the materials used to prepare the surface of the tank, and the painting or coating water systems used to protect against corrosion.

Engineers should provide cathodic protection as necessary (especially for underground or partially buried tank installations).

3. Reservoir membrane liners, plastic tanks, fiberglass tanks, or other materials that substantially contact drinking water **must** be ANSI/NSF Standard 61 certified (WAC 246-290-220).
4. It is important to follow the manufacturer's instructions when applying protective coatings. Temperature, ventilation, and the thickness of the applied layers affect the time required to cure coatings and the potential for contaminants to leach into the water. If there is any concern over the curing of the coatings and materials, or leaching from the reservoir liner, we may require additional water quality monitoring from the reservoir before it goes into service. Appendix G includes additional guidance on testing materials that leach.

7.7 Placing a Reservoir into Service

Before placing a reservoir into service, it **must** be properly tested, inspected, and disinfected (WAC 246-290-120(4)). The specifications for the reservoir design should clearly identify:

1. **Curing of coatings.** All coatings in contact with potable water **must** be certified under ANSI/NSF Standard 61 (WAC 246-290-220). In some cases, you may need to allow the coating to cure for multiple days before disinfecting it. Following disinfection, you should conduct additional water quality testing (AWWA 2011a; Ten State Standards 2012). This water quality testing includes analyses for taste, odors, VOCs, pH, and conductivity to make sure water is palatable and meets drinking water standards before serving it to customers.
2. **Disinfection and bacteriological testing requirements.** There are a few different standard approaches for disinfecting a reservoir, such as filling the reservoir with chlorinated water so that, at the end of the soak period, the system can maintain a chlorine residual of at least 10 mg/L. Another approach is to spray all surfaces with a solution containing at least 200 mg/L of available chlorine as described in *AWWA C652 Standard for Disinfection of Water Storage Facilities* (AWWA 2011a). At the end of the disinfection period and after chlorine residuals return to acceptable concentrations for distribution, the water system **must** collect and analyze a coliform sample (WAC 246-290-120(4)). If coliform are present, additional disinfection and bacteriological testing will be necessary.
3. **Leakage testing.** Standards for leak testing reservoirs and reservoir roofs vary depending on the type of material used to construct the reservoir (AWWA 2004; AWWA 2006; AWWA 2009a; AWWA 2011b). Regardless of the materials used in

construction, engineers should identify specific methods for testing and criteria for passing.

Only after the reservoir has been cleaned, tested, and disinfected, and testing results shows that the water quality from it is acceptable may it be placed into service. Water systems **must** submit a [Construction Completion Report Form](#) (DOH 331-121) to DOH within 60 days after they complete a reservoir project and before they place the reservoir into service (WAC 246-290-120(5)).

References

- ALA. 2001. *Seismic Fragility Formulations for Water Systems – Part 1 Guideline*. American Lifelines Alliance.
- ASCE, AWWA, and WEF. 2004. *Interim Voluntary Security Guidance for Water Utilities*. American Water Works Association, Denver, CO.
- ASCE, AWWA, and WEF. 2006. *Guidelines for the Physical Security of Water Utilities*. American Water Works Association, Denver, CO.
- ASCE 7. American Society of Civil Engineers, 2016, *Minimum Design Loads and Associated Criteria for Buildings and Other Structures*, ASCE/SEI 7-16, ISBN 9780784414248.
- AWWA and EES Inc. 2002. *Finished Water Storage Facilities*. USEPA, Washington, DC.
- AWWA. 2008. *Distribution System Requirements for Fire Protection: AWWA Manual M31*. American Water Works Association, Denver, CO.
- AWWA. 2013. *Steel Water Storage Tanks: AWWA Manual M42*. American Water Works Association, Denver, CO.
- AWWA. 2011a. *C652 – AWWA Standard for Disinfection of Water Storage Facilities*. AWWA. Denver, CO.
- AWWA. 2011b. *D100 - AWWA Standard for Welded Carbon Steel Tanks for Water Storage*. AWWA. Denver, CO.
- AWWA. 2009a. *D103 - AWWA Standard for Factory Coated Bolted Carbon Steel Tanks for Water Storage*. AWWA. Denver, CO.
- AWWA. 2004. *D110 - AWWA Standard for Wire- and Strand-Wound Circular Prestressed Concrete Water Tanks*. AWWA. Denver, CO.
- AWWA. 2006. *D115 - AWWA Standard for Tendon-Prestressed Concrete Water Tanks*. AWWA. Denver, CO.
- Edwards, J. and J. Maher. 2008. "Water Quality Considerations for Distribution System Storage Facilities," *Journal AWWA*, Vol. 100, Issue 7, pp. 60-65.

Friedman, M., Pierson, G., Kimeyer, G., Harrison, S., & Martel, K. 2005 . *Development of distribution system water quality optimization plans*. Awwa Research Foundation, Denver, CO.

Grayman, W.M. and G.J. Kirmeyer. 2000. *Water Distribution Handbook*, Chapter 11: "Quality of Water in Storage," McGraw-Hill, New York, NY.

Great Lakes-Upper Mississippi River Board of State and Provincial Public Health and Environmental Managers. 2012. Ten State Standards - *Recommended Standards for Water Works*, "Part 7: Finished Water Storage," Health Education Service, Albany, NY.

Kirmeyer, G., L. Kirby, B.M. Murphy, P.F. Noran, K.D. Martel, T.W. Lund, J. L. Anderson, and R. Medhurst. 1999. *Maintaining Water Quality in Finished Water Storage Facilities*, AWWA Research Foundation, Denver, CO.

Martel, K.D., G.J. Kirmeyer, B.M. Murphy, P.F. Noran, L. Kirby, T.W. Lund, J.L. Anderson, R. Medhurst, and M. Capara. 2002. "Preventing Water Quality Deterioration in Finished Water Storage Facilities," *Journal AWWA*, Vol. 94, Issue 4, pp. 139-148.

National Research Council (NRC). 2005. *Public Water Supply Distribution Systems: Assessing and Reducing Risk*. Washington, DC: National Academies Press.

Oregon Health Authority. 2009. *Physical Security for Drinking Water Facilities*. Salem, OR.

USEPA. 2015. Fall 2015 Regulatory Agenda. United States Environmental Protection Agency, Washington DC.

Walski, T.M. 2000. *Water Distribution Handbook*, Chapter 10: "Hydraulic Design of Water Distribution Storage Tanks," McGraw-Hill, New York, NY.

Chapter 8: Booster Pump Station Design

8.0 Introduction

Many water systems need booster pumping facilities to maintain adequate pressure due to treatment, topography, or high design flows. In these water systems, booster pumps are an integral part of the distribution system—like the water mains—that must be adequate and reliable. Inadequate or unreliable booster pumping facilities leave a water system vulnerable to inadequate pressure, customer complaints, and a distribution system at risk of contamination.

Booster pumps work with pressure tanks, reservoirs, variable frequency drives, and control valves to maintain a consistent pressure range in the distribution system. This chapter describes requirements for minimal design pressures and reliability standards (WAC 246-290-230 and 420) and offers design guidance on booster pump station:

- Pumping system capacity.
- Location and site considerations.
- Material selection, piping, and appurtenances.

The objective of booster pump station design is to provide the water system with adequate and resilient water pumping facilities that protect the quality of water in the distribution system while delivering needed supply to consumers over a wide range of operating conditions. To protect public health, it is important to consider each booster pump design element thoroughly, follow appropriate construction standards, and implement best management and operating practices.

8.1 Booster Pump Station Capacity

In general, the booster pump station, and any other supplies to the zone—wells, other pressure zones, and storage reservoirs—**must** be able to meet minimum demand and pressure requirements (WAC 246-290-230(5) and (6)). The demand conditions include the maximum daily demand (MDD), peak hourly demand (PHD), and fire flow for the area the pump station serves, and the supplying pressure zone(s). See Chapter 3 for guidance on estimating demand.

One of the key factors in sizing a booster pump station is the storage available in the pressure zone the booster pump station serves. If there is gravity storage in the pressure zone, this manual calls the zone an **open system** because there is a water surface open to the atmosphere. If there is no finished water reservoir in the pressure zone, this

manual calls that part of the distribution system a **closed system**. The process of sizing booster pump stations for open and closed systems varies slightly as described in the following subsections.

We recommend that engineers design booster-pumping facilities to accommodate at least the next 10 years of water system development, and preferably, the period associated with full water system build-out for its service area. Variable frequency drive pumps are particularly well suited to accommodate growth (see Appendix B.3).

Each reservoir overflow should be able to discharge the combined pumping capacity of all sources without damage to the reservoir or downstream property. An open system booster-pump station is a source of supply to a reservoir. Design engineers should ensure existing reservoir overflow capacity could safely discharge the added supply from the new or expanded pump station.

8.1.1 Open System Booster Pump Station Sizing Guidelines

For open systems with adequate equalizing storage, the minimum discharge capacity of the booster pump station(s)—plus the supply from other sources—is at least the MDD of the pressure zone and any sequential zones served (WAC 246-290-230). In addition, a booster pump station **must not** create low pressure in any supplying zone during peak demand periods such as when fighting fires (WAC 246-290-420). Table 8-1 summarizes specific design requirements.

**Table 8-1
Summary of Hydraulic Analysis Conditions for Open System Booster Pump Stations**

Scenario	Supplying Pressure Zone(s)		Pump Station Discharge	Discharge Pressure Zone	
	Demand Conditions	Pressure Requirement		Demand Conditions	Pressure Requirements
1	PHD	Maintain 30 psi min.	MDD ¹	MDD	Maintain 30 psi min.
2	MDD + FF ²	Maintain 20 psi min.	MDD ¹	MDD	Maintain 30 psi min.
3	MDD	Maintain 30 psi min.	MDD + FF ^{1, 2}	MDD + FF	Maintain 20 psi min.

¹ Or pump station operating capacity, whichever is greater.

² FF (fire flow): The largest pump supplying the supplying pressure zone (scenario 2) and the largest pump supplying the discharge pressure zone (scenario 3) must be assumed to be out of service for water systems located within a Public Water System Coordination Act area, where pumping supplies fire flow.

If an open booster pump station is the sole supply to a pressure zone, the pump station design **must** supply the MDD of the pressure zone(s) with all pumps in service (WAC 246-290-230), and should be able to supply the average day demand (ADD) with the largest pump out of service. If multiple sources supply a pressure zone, consider all of them when assessing the size and number of pumps needed to satisfy the MDD and ADD standard described above. If the booster pump station is a critical part of the water system, the engineer should consider designing additional mechanical redundancy and hydraulic capacity into the pump station.

8.1.2 Closed System Booster Pump Station Sizing Guidelines

The pumps in a closed system booster pump station supply the entire flow and pressure the service area requires. Because state rules require the water system to provide PHD at no less than 30 psi at all service connections throughout the distribution system, the engineer **must** design a closed system pump station to meet this requirement (WAC 246-290-230(5)).

For reliability purposes, the booster pump station should be able to meet the PHD when the largest capacity booster pump is out of service. Because the service area of a closed system pump station depends entirely on the continuing operation of the pump station, the engineer **must** consider standby power facilities (WAC 246-290-420). In addition, a closed system pump station **must** be able to meet the fire flow requirements the local fire marshal defined. Where fire flow is required, the pumping system **must** be able to maintain a minimum of 20 psi at ground level at all points in the distribution system while supplying MDD plus needed fire flow (WAC 246-290-230(6)). Table 8-2 summarizes these design requirements.

Table 8-2

Summary of Hydraulic Analysis Conditions for Closed System Booster Pump Stations

Scenario	Supplying Pressure Zone		Pump Station Discharge	Discharge Pressure Zone	
	Demand Conditions	Pressure Requirement		Demand Conditions	Pressure Requirements
1	PHD	Maintain 30 psi min.	PHD ¹	PHD	Maintain 30 psi min.
2	MDD + FF ²	Maintain 20 psi min.	PHD ¹	PHD	Maintain 30 psi min.
3	MDD	Maintain 30 psi min.	MDD + FF ^{1,2}	MDD + FF	Maintain 20 psi min.

¹ Or pump station operating capacity, whichever is greater.

² FF (fire flow): The largest pump supplying the supplying pressure zone (scenario 2) and the largest pump supplying the discharge pressure zone (scenario 3) must be assumed to be out of service for water systems located within a Public Water System Coordination Act area, where pumping supplies fire flow.

8.1.3 Fire Flow Requirements for Pump Stations in Coordination Act Areas

New booster pump stations in an area governed by the Public Water System Coordination Act (Chapter 246-293 WAC), **must** be able to meet fire flow with the largest capacity booster pump out of service (WAC 246-293-660(1)). Open-system booster pump stations can use reservoir storage in the pressure zone supplied to meet fire flow requirements. The remaining pumps, in conjunction with supply from the reservoir, **must** be able to maintain a minimum of 20 psi at ground level at all points in the distribution system while supplying MDD plus needed fire flow (WAC 246-290-230(6)).

In general, you should be cautious using a closed booster pump station if fire flow is required because a closed booster pump station is less reliable than gravity storage. A new booster pump station serving a closed system should be designed with back-up power operated by an automatic transfer switch if power outages exceed the threshold standards in WAC 246-293-660(1).

8.1.4 Flow Control for Booster Pump Stations

There are often wide variations in diurnal demand in the pressure zone(s) served by a pump station. There are several ways to meet these demand fluctuations, including:

Constant speed pumps with pressure tanks. This design approach is most often used for small, closed pressure zones. In these pump stations, pressure switches start and stop the pumps as demand increases and decreases. Pressure tanks maintain system pressure within a fixed range and limit pump cycling. Additional information on sizing pressure tanks with constant speed pumps is in Chapter 9.

Variable frequency drives (VFDs). This design approach offers many advantages, including energy savings, improved pressure and flow control, and elimination of pressure transients associated with abrupt start/stop of single-speed pumps. Flow control is provided through a feedback loop from a pressure sensor on the pump discharge to the VFD controller governing pump motor rotational speed (and therefore flow). See Appendix B.3 for more information on VFDs. For closed booster pump stations, a pressure tank still is necessary to minimize pump cycling under very low flow conditions.

A jockey pump for low flow conditions. Designers can use a small pump, commonly called a "jockey pump," to meet demand during low flow conditions. Water systems use a jockey pump with larger pumps to meet peak demands. For closed booster pump stations, a pressure tank still is necessary to minimize pump cycling.

Cycle control valves with a pressure tank. These specialized pressure regulating valves keep a constant downstream pressure over a wide range of flows. A pressure tank still is required for closed pressure zones served by pumps stations that use these valves to accommodate the need for pump cycling control under very low flow conditions. Additional information on cycle control valves is in Appendix B.2.

8.2 General Booster Pump Station Site Considerations

Booster pump station designs **must** comply with state or locally adopted building, mechanical, electrical, and land use codes (WAC 246-290-200(b)). The contents of these codes, not to mention local ordinances, exceed the scope of this manual. Overall, you should review locally adopted codes and ordinances that could affect the siting and design of a booster pump station in a project report. These considerations include, but are not limited to:

- Zoning compliance, building code compliance, and community acceptance. Noise can be an issue for pump stations located near parks or residences. The maximum permitted sound level can be as low as 45 dBA in residential areas at night (WAC 173-60-040).
- Operator access, equipment maintenance, and safety. The pumps and other mechanical equipment need periodic maintenance. As such, the pump station design should make it easy to inspect, operate, and maintain the equipment:
 - Beware of creating permit-required confined spaces. Booster pump stations in below grade vaults or other permit-required confined spaces (defined in Chapter 296-809 WAC) can create operations and maintenance issues. See Appendix C for Department of Labor and Industries contact information.
 - Provide adequate space around mechanical equipment and electrical equipment. We recommend at least 36 inches clearance between piping, pumps, and other mechanical equipment. Electrical codes govern the minimum clearance in front of electrical panels; these clearances are at least 36 inches and can be 60 inches or more for high voltage panels (Sanks et al. 1998; AWWA/ASCE 2012).
 - Facilitate removing and installing heavy valves and equipment. Any piece of equipment that weighs more than 100 pounds should be accessible by crane or other lifting assistance. Other means of access include large doorways or roof hatches to facilitate removing heavy equipment directly into a truck. Areas where the operator will walk or perform maintenance should be clear of overhead obstructions to a height of at least 7 feet (Sanks et al.1998).

- Hearing protection and other measures to protect people in the pump station is required when the noise exceeds 85 dBA (Chapter 296-817 WAC).
- Geotechnical engineering field investigations, including:
 - Site drainage
 - Soil type and soil-bearing strength
 - Groundwater table elevation
 - Soil stability, liquefaction, and/or slope failure analysis
- Electrical power supply
 - Reliability: Engineers should assess the reliability of the power supply and the need for standby generators. See Section 5.11.1.
 - Sizing: While deciding where to site very large pump stations and pump stations in rural areas, engineers should consider the capacity of the electrical grid and the need for required upgrades in the local electrical service.

Engineers should address many other items as part of pump station design. See additional items highlighted in Checklist A.3.6 in Appendix A.

8.2.1 Natural Hazard Considerations

Natural disasters could damage pump stations to the point that they fail to operate. Engineers should design and locate pump stations to minimize vulnerability to damage from:

- Avalanches
- Earthquakes
- Floods
- Landslides
- Tree falls
- Tsunamis
- Windstorms
- Wildfire

To meet state and local requirements, engineers **must** address geologic risk (seismic and unstable slopes) when designing pump stations (WAC 246-290-200). The state Department of Natural Resources (DNR) has [geologic hazard maps](#) that identify seismic and other natural hazards. DNR contact information is in Appendix C.

Engineers should prioritize making booster-pump stations that serve water for essential services earthquake resilient, so that the booster pumps remain functional after seismic

events. Essential services include medical facilities; power plants; fuel refining, storage, and distribution facilities; food production, storage, and distribution facilities; emergency response command and communication centers; and emergency shelters. You should follow the requirements in ASCE 7 to design earthquake resilient pump stations. And, the water system should have an onsite emergency power source or be able to operate with a portable emergency power source (ASCE 7).

You can reduce or mitigate seismic risk by:

- Being aware of permanent ground displacement or intense ground shaking (in fault zones) that could affect the pump station and designing the pump station to accommodate these hazards.
- Bracing and/or anchoring pump station piping, motor control centers, cranes and other equipment needed for pump station operation.
- Using flexible couplings on pipelines connected between elements that may move differentially.

Various design guidelines highlight the multiple seismic vulnerabilities of piping and large mechanical equipment in some pump stations (ALA 2002; ALA 2004). In areas with potential for significant ground motion, you may need to seek the services of a professional qualified to assist in the design of pipe bracing, equipment support, and other aspects of design.

8.3 Booster Pump Station Design Details

The design of a booster pump station **must** comply with state and locally adopted national model codes (WAC 246-290-200(b)). The details of these building, electrical, and mechanical codes are beyond the scope of this manual. The design of all but the simplest pump stations may require the involvement of licensed professionals with detailed knowledge and experience with the codes (WAC 197-27A-020(2)). This section and Checklist A.3.6 in Appendix A provide further guidance on basic pump station design elements.

Meters and gauges

To help ensure that pumps perform as designed, each pump should have:

- A pressure gauge between the pump and the discharge check valve
- A compound gauge on its suction side; and
- A way to meter the discharge.

Each booster pump station should have a meter capable of measuring the total water pumped and pumping rate.

Valves

Each pump should have valves adequate to permit satisfactory operation, maintenance, and equipment repair. There should be an isolation valve on the suction and discharge side of each booster pump. Other appurtenances should include:

- A check valve on the discharge side of each booster pump.
- End connections for booster pumps, pressure vessels, and large equipment should have flexible flanged coupling adapters, or dismantling joints for larger units and threaded unions for smaller units. They will simplify maintenance and provide flexibility in installation.
- Pump control valves and surge anticipation valves, as needed, to prevent destructive hydraulic transients during normal and emergency pump starts or stops.
- Air relief valves at any high points in the piping.

Controls and Alarms

The pump station design should include an alert to the operator if a pump failure or abnormally high or low pressure occurs. One approach is to have a visible external alarm light (with a battery backup). If practical, the pump-station alarm system should connect to an auto-dialer to notify the operator, water system owner, and other key personnel of any unusual conditions or unauthorized entry.

Piping Material

The strength, stiffness, ductility, and resistance to water hammer or pump cycling make steel and ductile iron the most suitable choices for exposed piping in pump stations (Sanks et al. 1998). Plastic pipe such as PVC and HDPE are prone to fatigue failure from pump cycling, become brittle at low temperatures, or lose strength at temperatures that can occur normally in pump stations. For those reasons, if considering the use of PVC or HDPE pipe inside a booster pump station, approach with caution and proceed only with approval from the water system owner. The design should also address special anchoring or support requirements for equipment and piping.

Piping Connections

Engineers should use seismically appropriate pipe materials and connections for all pipes located within the pump station, directly below it, and within 20 feet of the pump station foundation. It will be difficult and expensive to repair or replace these pipes if they fail after the pump station is in place. Therefore, engineers should evaluate these pipes for corrosion potential and include appropriate corrosion mitigation.

Taps on the discharge piping

Booster pump stations are convenient places to provide water quality monitoring and, if necessary, provide booster chlorination or other water quality adjustments. You should consider installing at least two taps on the common discharge line:

- A sample tap to allow for monitoring water quality.
- A tap to allow for booster disinfection in an emergency.

Access for pipe cleaning and condition assessment tools

As distribution pipes age, they gradually accumulate solids and suffer from corrosion. As a result, it may be useful to install a pig-launch or other access point on the pump station discharge piping.

8.4 Individual Booster Pumps

An individual booster pump station may **not** be installed to serve a property on a new water system or an addition to an existing water system (WAC 246-290-230(5)).

Existing water systems may need to install individual service booster pumps to meet minimum pressure requirements for specific connections. Engineers **must** submit such designs to DOH for approval (WAC 246-290-125). The water system, not the consumer is responsible for individual booster pumps installed because the minimum 30 psi standard in WAC 246-290-230(5) cannot be met. Water systems may only use individual booster pumps on an interim basis, typically less than 10 years, and they **must** manage and control any individual booster pumps (WAC 246-290-230(8)). The water system should evaluate vulnerabilities in the distribution system until it can make upgrades that eliminate such low-pressure areas and the associated need for individual booster pumps.

If the pressure in the distribution pipeline meets the minimum requirements of WAC 246-290-230(5), a water system may allow installation of individual booster pumps to serve customers who want additional pressure. For example, developers may install booster pumps to serve structures built at significant elevations above the service meters. The water system should approve the design, installation, and operation of such individual booster pumps. Moreover, the water system **must** ensure the booster pumps do not adversely affect pressure in the rest of the distribution system (WAC 246-290-230 and 420), and address all cross-connection control concerns (WAC 246-290-490). Building owners are responsible for booster pumps installed where water systems meet the minimum 30 psi standard in WAC 246-290-230(5). Systems may allow them on a permanent basis.

8.4.1 Cross-Connection Control for Individual Booster Pumps

When designing or installing an individual service booster pump, the engineer should recognize that the location the individual booster pump will serve is a **cross-connection hazard**. Under normal circumstances, pressure on the downstream side of the individual service booster pump is higher than system pressure. However, the check valve could fail or leak, causing water from the premises to backflow through the pump and into the distribution main. Therefore, a cross-connection control specialist **must** assess the degree of hazard for facilities that use booster pumps and approve the installation of an acceptable backflow assembly (WAC 246-290-490(4)(e)(iii)).

Special consideration should be given for booster pumps within multistory buildings given the higher pressures in these structures relative to the distribution system, internal storage in some cases, and greater potential for a multitude of uses, including high health cross connection hazards that require premises isolation (PNWS-AWWA 1996).

Water that enters the consumer's premises is "used water." Therefore, any piping arrangement that allows pressure relief **must not** be directed back into the distribution system (WAC 246-290-490(2)(k)).

8.5 Placing a Booster Pump Station into Service

Engineers should consider field-testing pumps to ensure they are installed properly and able to deliver their rated performance. A field pump test consists of measuring the pump discharge, pressure or head, power input, and speed. Engineers then use this information to determine whether there are operational issues with the pumps as outlined in *AWWA E103- Standard for Horizontal and Vertical Line-Shaft Pumps* (AWWA 2007).

Before a booster pump station can be placed into service, it **must** be properly tested, inspected, and disinfected (WAC 246-290-120(4)). The specifications for the pump station should clearly identify the disinfection and bacteriological testing requirements. The [WSDOT/APWA standard specifications](#) (Division 7) and *AWWA C651 - Standard for Disinfecting Water Mains* can be used for this purpose (WSDOT/APWA 2016; AWWA 2014). Water systems **must** submit a [Construction Completion Report Form](#) (DOH 331-121) to DOH within 60 days after they complete a pump station project and before they place the pump station into service (WAC 246-290-120(5)).

References

- ALA. 2002. *Seismic Design and Retrofit of Piping Systems*. American Lifelines Alliance.
- ALA 2004. *Guide for Seismic Evaluation of Active Mechanical Equipment*. American Lifelines Alliance.
- ASCE 7. American Society of Civil Engineers, 2016, *Minimum Design Loads and Associated Criteria for Buildings and Other Structures*, ASCE/SEI 7-16, ISBN 9780784414248.
- AWWA and American Society of Civil Engineers (ASCE). 2012. *Water Treatment Plant Design*, 5th Edition, Chapter 30 "Operations and Maintenance Considerations During Plant Design". McGraw-Hill. New York, NY.
- AWWA. 2007. *E103 - AWWA Standard for Horizontal and Vertical Line-Shaft Pumps. Appendix B: Field Testing of Pumps*. American Water Works Association, Denver, CO.
- AWWA. 2014. *C651 - AWWA Standard for Disinfecting Water Mains*. American Water Works Association, Denver, CO.
- PNWS-AWWA. 1996. *Cross Connection Control: Accepted Procedure and Practice Manual*, 6th Edition. Pacific Northwest Section - American Water Works Association, Vancouver, WA.
- Sanks, R. L., G. Tchbanoglous, B.E. Bosserman, G. M. Jones. 1998. *Pumping Station Design*, 2nd Edition, Chapter 4 "Piping" Butterworth Heineman, Boston, MA.
- Sanks, R. L., G. Tchbanoglous, B.E. Bosserman, G. M. Jones. 1998. *Pumping Station Design*, 2nd Edition, Chapter 24 "Designing for Easy Operation and Maintenance" Butterworth Heineman, Boston, MA.
- WSDOT and APWA. 2016. *Standard Specifications for Road, Bridge, and Municipal Construction – Division 7-09: Water Mains*. WSDOT Pub. M41-10. Washington State Department of Transportation, Olympia, WA.

Chapter 9: Pressure Tanks

9.0 Introduction

A pressure tank contains pressurized air and water. The compressed air acts as a cushion to exert or absorb pressure as needed. There are two types of pressure tanks. **Bladder tanks** have some type of membrane separating the air from the water. **Hydropneumatic tanks** allow air-water contact.

Pressure tanks work with pumps in closed systems (see Chapter 8) to maintain pressure within a selected range without requiring continuous pump operation. This chapter offers design guidance on:

- Pressure tank sizing
- Department of Labor and Industries standards
- Pressure tank type selection and appurtenances

The objectives of pressure tank design are to avoid premature pump failure due to excessive cycling and to protect the quality of water in the distribution system by reliably maintaining distribution system pressure within the design operating range. The needed number and size of pressure tanks depends on how the pump discharge rate is controlled. Control options include:

- Variable frequency drives
- Single-speed pumps with on-off pressure switches
- Cycle control valve with downstream pressure set point

Pressure tanks are not appropriate for providing equalizing, standby, or fire-protection storage. If such storage is required, design engineers should select ground or elevated storage as described in Chapter 7.

9.1 Pressure Tank Sizing

The portion of pressure-tank volume that can be usefully withdrawn between pumping cycles while maintaining 30 psi pressure throughout the distribution system under peak hour demand (PHD) conditions (WAC 246-290-230(5)) is referred herein as **withdrawal capacity**. The procedure for selecting or sizing bladder tanks differs from that used for hydropneumatic tanks.

9.1.1 Bladder Tank Sizing

Bladder tank sizing depends on the number of “selected-size” tanks needed to provide pump protection. Bladder tanks are assumed to be pre-charged with air to a pressure of about 5 psi below the low operating (pump-on) pressure for the system. Design engineers need to call out this stipulation in the design specifications.

Design engineers may use Equation 9-1 to determine the number of bladder tanks of a certain gross volume, based on the pump-on and pump-off pressure settings for single-speed pumps controlled by a pressure switch. See Section 9.1.5 for an alternative pressure tank design approach based on use of a cycle control valve or variable frequency drive pumping system.

$$\text{Equation 9-1: } T \geq \frac{(R)(Q_p)}{(N_c)(V_B)}$$

Where:

- R** = $\frac{15(P_1 + 14.7)(P_2 + 14.7)}{(P_1 - P_2)(P_2 + 9.7)}$ (or refer to Table 9.1)
- V_B** = The gross volume of an individual bladder tank in gallons (“86-gallon tank,” for example).
- T_s** = The number of bladder tanks of gross volume **V_B**
- P₁, P₂** = Pressures selected for water system operation in psig (gauge pressures). **P₁** corresponds to the pump-off pressure and **P₂** to the pump-on pressure
- N_c** = Number of pump operating cycles per hour. This should be the maximum number of pump motor starts per hour as recommended and documented by the pump or motor manufacturer. Without such information, design engineers should use no more than six cycles per hour.
- Q_p** = Pump delivery capacity in gallons per minute at a midpoint of the selected pressure range. Determine this by examining pump curves or tables. If this value is not used, the designer should use the Q_p that occurs at P₂ (pump-on).

9.1.2 Bladder Tank Design Procedures

The following is a step-by-step procedure for designing bladder-tank pressurized storage systems used in connection with single-speed pumps with on-off pressure switches. See application of these procedures in Example 9-1 in Section 9.6.

1. Based on water system hydraulic requirements, select the operating range of pressure, P_1 (pump-off) and P_2 (pump-on). P_2 pressure **must** satisfy minimum system pressure requirements (WAC 246-290-230).
2. Select the operating cycles per hour, N_c . The value for N_c should not exceed six cycles per hour unless the pump manufacturer justifies a larger value. For multiple pump installations, N_c may be increased if an automatic pump switchover system is installed to automatically alternate pumps.
3. Determine the delivery capacity, Q_p , for the midpoint of the operating pressure range $[(P_1 + P_2)/2]$. The pump capacity at P_2 pressure **must** meet system demand and pressure requirements (WAC 246-290-230 and 420).
4. Select an appropriate gross volume, V_B , for each bladder tank (bladder tank size). This volume should be available from bladder tank manufacturers. We recommend limiting individual bladder tank sizes to no more than 220 gallons gross volume.
5. Calculate the value of R . For convenience, Table 9.1 gives R -values for several commonly used pressure ranges.
6. Use Equation 9-1 (see above).
7. Round up the value determined in Step 6 to the nearest whole number. This is the number of tanks, each with the selected volume, V_B , to be used for pump protection.
8. See Appendix A.3.7 for further design recommendations.

**Table 9-1
R Values for Various Pressure Tank Ranges**

P₂ pump-on pressure	P₁ pump-off pressure				
	55 psi	60 psi	65 psi	70 psi	80 psi
35 psi	58.1	49.8	44.3		
40 psi	76.7	61.7	52.6	46.6	
45 psi		81.5	65.2	55.5	
50 psi			86.4	68.8	51.3
60 psi					76.1

9.1.3 Hydropneumatic Tank Sizing Equations (bottom outlet)

Horizontally-Oriented Tanks

Design engineers may use Equation 9-2 to determine the gross volume of a hydropneumatic tank they will install horizontally, based on the pump-on and pump-off pressure settings for single speed pumps controlled by a pressure switch.

See Section 9.1.5 for an alternative pressure tank design approach based on use of a cycle control valve or variable frequency drive pumping system.

Equation 9-2:

$$V_t = \frac{P_1 + 14.7}{P_1 - P_2} \times \frac{15 Q_p (\text{MF})}{N_c}$$

Vertically-Oriented Tanks

Design engineers may use Equation 9-3 to determine the gross volume of a hydropneumatic tank they will install vertically, based on the pump-on and pump-off pressure settings for single-speed pumps controlled by a pressure switch.

Equation 9-3:

$$V_t = \frac{P_1 + 14.7}{P_1 - P_2} \times \frac{15 Q_p (\text{MF})}{N_c} + 0.0204 D^2$$

Where:

- V_t** = Total tank volume in gallons.
- P₁, P₂** = Pressures selected for water system operation in psig (not absolute pressures). **P₁** corresponds to the pump-off pressure and **P₂** to the pump-on pressure.
- N_c** = Number of pump operating cycles per hour. This should be the maximum number of pump-motor starts per hour as recommended and documented by the pump or motor manufacturer. Without such information, design engineers should use no more than six cycles per hour.
- Q_p** = Pump delivery capacity in gallons per minute at the midpoint of the selected pressure range. Determine this by examining pump curves or tables. If this value is not used, the Q_p that occurs at P₂ (pump-on) should be used.
- D** = Tank diameter in inches.
- MF** = A multiplying factor related to tank diameter to include the volume needed to maintain a six-inch water seal above the tank inlet-outlet installed at the bottom of the tank. See Table 9-3. Use this factor only for sizing a horizontal tank. MF for vertically-oriented tanks equals 1.

9.1.4 Hydropneumatic Tank Design Procedures

The following is a step-by-step procedure for designing horizontally or vertically oriented hydropneumatic pressurized storage systems used in connection with single-speed pumps with on-off pressure switches. See application of these procedures in Example 9-2 in Section 9.6.

1. Based on water system hydraulic requirements, select the operating range of pressure, **P₁** (pump-off) and **P₂** (pump-on). **P₂** pressure **must** satisfy minimum system pressure requirements (WAC 246-290-230).
2. Select the operating cycles per hour, **N_c**. The value for **N_c** should not exceed six cycles per hour unless the pump manufacturer justifies a larger value. For multiple pump installations, **N_c** may be increased if an automatic pump switchover system is installed to automatically alternate pumps.
3. Determine the delivery capacity, **Q_p**, for the midpoint of the operating pressure range [**(P₁ + P₂)/2**]. The pump capacity at **P₂** pressure **must** meet system demand and pressure requirements (WAC 246-290-230 and 420).

When multiple pumps will be pumping through a pressure tank, the Q_p can be based on the largest pump.

4. For either vertical or horizontal tanks, select a tank diameter (in inches) that suits the space available in the pump house.
5. For a **horizontal tank**, refer to Table 9-3 for the multiplying factor, **MF**, needed to accommodate the required water seal. The MF in this table is calculated to provide a 6-inch water seal above the tank inlet-outlet installed at the bottom of the tank. If a **vertical tank** is to be used, the additive value for the water seal volume can be calculated directly and is already included in Equation 9-3.
6. Calculate the necessary tank volume by incorporating the parameters above into the appropriate sizing equation. The tank is subject to the American Society of Mechanical Engineers (ASME) code construction requirements identified in Section 9.2.
7. Check the calculated volume requirement with any commercial tank size table (see Table 9-2) to see if a tank that meets the necessary volume at the selected diameter is available. If a tank that provides the necessary volume at the diameter selected is not available, or cannot be fabricated, select another tank diameter and repeat the sizing calculations until the design is satisfied. This may also be necessary if the pump house layout will not accommodate the length needed.
8. See Appendix A.3.7 for further design recommendations.

Table 9-2
Pressure Tank Dimensions¹

Dimensions, Capacities and Tappings							
Tank Model Number	Capacity Gallons	Dimensions, Inches			Tappings, FPT ²		
		Outside Diameter	Shell Length	Approximate Overall Length	Relief ³	Blowdown ⁴	Water In & Out ⁵
		A	B	C	R	S	W
144	36	14	48	58	¾		1
145	44	14	60	70	¾		1
164	48	16	48	59	¾		1
165	58	16	60	71	¾		1
166	69	16	72	83	¾		1
184	62	18	48	60	¾		1¼
185	75	18	60	72	¾		1¼
186	88	18	72	84	¾		1¼
204	77	20	48	62	1		1¼
205	93	20	60	74	1		1¼
206	109	20	72	86	1		1¼

Dimensions, Capacities and Tappings							
Tank Model Number	Capacity Gallons	Dimensions, Inches			Tappings, FPT ²		
		Outside Diameter	Shell Length	Approximate Overall Length	Relief ³	Blowdown ⁴	Water In & Out ⁵
		A	B	C	R	S	W
244	113	24	48	64	1		1¼
245	137	24	60	76	1		1¼
246	160	24	72	88	1		1¼
247	184	24	84	100	1		1¼
304	186	30	48	67	1		2
305	223	30	60	79	1		2
306	260	30	72	91	1		2
307	296	30	84	103	1		2
308	333	30	96	115	1		2
309	370	30	108	127	1		2
365	330	36	60	82	1		2
366	383	36	72	94	1		2
367	436	36	84	106	1		2
368	489	36	96	118	1		2
369	542	36	108	130	1		2
3610	594	36	120	142	1		2
426	533	42	72	96	1¼	2	2
427	605	42	84	108	1¼	2	2
428	677	42	96	120	1¼	2	2
429	749	42	108	132	1¼	2	2
4210	821	42	120	144	1¼	2	2
4211	893	42	132	156	1¼	2	2
4212	965	42	144	168	1¼	2	2
4213	1,037	42	156	180	1¼	2	2
4214	1,110	42	168	192	1¼	2	2
486	712	48	72	100	1¼	2	3
487	806	48	84	112	1¼	2	3
488	900	48	96	124	1¼	2	3
489	994	48	108	135	1¼	2	3
4810	1,089	48	120	148	1¼	2	3
4811	1,183	48	132	160	1¼	2	3
4812	1,277	48	144	172	1¼	2	3
4813	1,371	48	156	184	1¼	2	3
4814	1,465	48	168	196	1¼	2	3
548	1,160	54	96	126	1½	2	3
5410	1,398	54	120	150	1½	2	3
5411	1,517	54	132	162	1½	2	3
5412	1,636	54	144	174	1½	2	3
5413	1,755	54	156	186	1½	2	3
5414	1,874	54	168	198	1½	2	3

Dimensions, Capacities and Tappings							
Tank Model Number	Capacity Gallons	Dimensions, Inches			Tappings, FPT ²		
		Outside Diameter	Shell Length	Approximate Overall Length	Relief ³	Blowdown ⁴	Water In & Out ⁵
		A	B	C	R	S	W
5415	1,993	54	180	210	1½	2	3
5416	2,112	54	192	222	1½	2	3
6010	1,750	60	120	154	1½	2	3
6012	2,044	60	144	178	1½	2	3
6014	2,338	60	168	202	1½	2	3
6016	2,632	60	192	226	1½	2	3
7210	2,609	72	120	160	1½	3	4
7212	3,032	72	144	184	1½	3	4
7214	3,455	72	168	208	1½	3	4
7216	3,878	72	192	232	1½	3	4

Above data is based on use of Elliptical Heads with 2" max SF.

¹ Table for example only. You may use any commercial table.

² "FPT" means female pipe thread.

³ "Relief" means size of FPT provided for installation of pressure relief valve.

⁴ "Blowdown" means size of FPT provided for tank drain.

⁵ "Water in and out" means size of FPT provided for water inlet and outlet connections to tank.

Table 9-3
Multiplying Factors Ensuring a 6-inch Water Seal Depth in a Horizontal Pressure Tank
 (Use with Equation 9-2)

Tank Nominal Diameter, inches	Multiplying Factor MF = $V_t / (V_t - V_6)$
12	2.00
16	1.52
20	1.34
24	1.24
30	1.17
36	1.12
48	1.08
54	1.06
60	1.05
72	1.04
84	1.03
96	1.03
120	1.02

Note: Use linear interpolation to determine MF values for diameters between those shown. Use an MF of 1.02 for horizontal tanks with diameters of 120 inches, or more.

9.1.5 Reduced Pressure Tank Sizing

Designs using variable frequency drive (VFD) pumping systems or pump cycle-control valves (CCV) will reduce the pressurized storage needed to protect pumps from over-cycling while maintaining adequate pressure in the distribution system. The criteria used to size pressure tanks serving a closed pumping system employing a VFD or CCV differs from the approach described in Sections 9.1.1 through 9.1.4.

CCVs and VFDs deliver water within the controlled pressure range at much lower flow rates than a standard design approach. Therefore, the size and/or number of pressure tanks required for water systems using a CCV or VFD will be lower than those required for single-speed pumps with on-off pressure switches (see sections 9.1.1 through 9.1.4). For more information on CCVs and VFDs, see appendices B.2 and B.3.

Cycle Control Valves

Engineers may use a pump cycle-control valve (CCV) to control the pressure in a distribution system. The CCV is intended to extend run time with minimal pressurized storage. It will maintain constant downstream pressure (i.e., the valve's set point) until demand downstream of the valve falls below the valve's prescribed low-flow level. At that point, the pressure will rise to the pressure switch pump-off set point. The valve is mechanically prevented from restricting flow past its preset minimum.

Depending on the model used, the control valve will **stop** pump operation at a preset threshold flow of as little as 1 or 2 gpm. At flows higher than that threshold, the valve will open or close in response to water system demands while the pump operates continuously. Design engineers who choose to use a CCV should include the head loss through the valve when determining the friction loss within the pump house.

The CCV is designed to keep the pump operating nearly all the time. For most water systems water demand will be very low during nighttime hours, resulting in prolonged pump operation at the upper end of its pump curve. If the manufacturer did not design the pump and motor for prolonged operation at that point on the pump curve, the pump will operate at low energy efficiency and at risk of premature failure. We recommend design engineers consult directly with the pump vendor or manufacturer to make sure the pump and motor are compatible with the intended operating conditions. Refer to Appendix B.2 for additional design information.

Variable Frequency Drives

A VFD is an electronic controller that adjusts the pump motor speed by modulating frequency and voltage. VFDs match motor speed and therefore pump output to specific water demand through a pressure control feedback loop to the variable frequency controller. Refer to Appendix B.3 for additional design information.

9.2 Labor and Industries Standards for Pressure Tanks

Pressure vessels, including bladder tanks greater than 37.5 gallons in gross volume, **must** be constructed according to ASME standards (RCW 70.79.080 (5)). The ASME standard is intended to promote a safe environment and protect against property damage, injury, and death caused by an abrupt failure of the tank.

General Agreement

In 2011, Washington Department of Labor and Industries (L&I) added to a list of proposed changes to RCW 70.79.080 an exemption for non-ASME bladder tanks used in public water systems. When legislation is in conflict with practices that meet the intent of the rule (in this case, safe operation of bladder tanks used in public water systems), L&I can enter into a general agreement with another agency until such time as the legislation is changed. Design engineers are responsible for addressing all applicable L&I requirements at the time of pressure tank design. Refer to current L&I rules and legislation.

An agreement between L&I and DOH requires that design of non-ASME bladder tank systems conform to the standards shown in [DOH 331-429](#). The agreement does not apply to hydropneumatic tanks. All hydropneumatic tanks **must** be constructed according to the latest ASME specification code (RCW 70.79.080), regardless of size.

All pressure tanks greater than 37.5 gallons gross volume **must** have a properly sized and installed ASME Section VIII pressure relief valve (WAC 296-104-316). Pressure tanks smaller than 37.5 gallons gross volume **must** have a properly sized and installed pressure relief device manufactured according to a recognized national standard, and design engineers must provide the specifications and certification to DOH. We strongly recommend the use of an ASME Section VIII PRV for pressure tanks smaller than 37.5 gallons gross volume. Pressure relief valves protect a pressure vessel from over-pressurization due to a failure in the pump control system, or intense heating of the water (e.g., during a fire), and pressure surge.

No isolation valves should be located between the pressure relief valve and the pressure tank. The potential for closure of the isolation valve during normal operations would negate the intended function of the pressure relief valve. For other design requirements and guidance, see *Pressure Relief Valves on Pressure Tanks* ([DOH 331-429](#)).

The maximum allowable working pressure for a tank is on the nameplate attached to the tank. For nonstandard pressure vessels, engineers can determine the maximum allowable working pressure with the L&I formula in WAC 296-104-405. A properly sized ASME PRV should have a relieving capacity sufficient to prevent pressure in the vessel from rising more than 10 percent or 3 psi above the maximum design set pressure of the pressure relief valve, whichever is greater.

L&I contact information is in Appendix C.

9.3 Locating Pressure Tanks

Pressure tanks should be located above normal ground surface and be completely housed. Buried pressure tanks are subject to floatation due to high groundwater, and could allow external corrosion to go undetected. L&I standards require at least 18 inches of clearance around the tanks for proper inspection, maintenance, and repair access (WAC 296-104-260). It may not always be practical to provide this much clearance all the way around a pressure tank. Therefore, L&I developed a [Boiler/Pressure Vessel Clearance Variance Request](#) form (F620-041-000). It is available from the L&I Boiler/Pressure Vessel website (<http://www.lni.wa.gov/forms/pdf/F620-041-000.pdf>).

9.4 Piping

Pressure tanks should have bypass piping to permit the water system to operate while it is being repaired or painted. Process control elements such as a pressure switch or hydraulic valves should not be located such that they are isolated during bypassed operations. Sampling taps should be provided before and after the pressure tank(s).

9.5 Hydropneumatic Pressure Tank Appurtenances

Good engineering design includes the following appurtenances:

- An automatic pressure relief valve safely discharging to a building drain (with installed air gap) or outside of the building.
- No valves may be between the PRV and the pressure tank.

- Float switch controlling water surface elevation (needed to avoid water logging the tank).
- Air compressor and air filter. If the compressor is oil lubricated, only food-grade oil may be used as a lubricant. The air compressor should be located and air filter should be specified to ensure capture and compression of healthy air quality and ease of air filter inspection, maintenance, and replacement.
- Sight glass or other tank level indicator.
- Tank drain, pressure gauge, and pressure switch.
- Vertical and lateral support appropriate for soil conditions and seismic risk.
- Access hatch 24 inches in diameter allowing inspection of the interior, with clearance of at least 5 feet between hatch and adjacent structures (WAC 296-104-260).

9.6 Pressure Tank Sizing - Examples

Below, two examples illustrate design guidance provided in Sections 9.1.1 through 9.1.4.

Example 9-1: Bladder Tank Sizing

For a mid-pressure range pumping rate, Q_p , of 40 gpm, a selected cycling of 6 cycles per hour, a bladder tank gross volume of 86 gallons, and a selected pressure range of 60/80, determine the required number of 86-gallon tanks as follows:

$$Q_p = 40; N = 6; V_B = 86$$

Using Table 9-1 for $P_2/P_1 = 60/80$, $R = 76.1$

Using Equation 9-1:

$$T_s > \frac{(R)(Q_p)}{(N_c)(V_B)}$$

$$T_s > \frac{(76.1)(40)}{(6)(86)} = 5.9$$

Select six 86-gallon bladder tanks for pump protection, pre-charged to 55 psi (5 psi below pump-on pressure).

Example 9-2: Horizontal Hydropneumatic Tank Sizing

1. Assume a small water system with the following:
 - a. 50 connections.
 - b. Peak hourly demand (from water system meter information) = 103 gpm.
 - c. Well capacity is 60 gpm.

- d. Booster pump draws from ground level atmospheric storage and pumps into horizontal pressure tank with bottom outlet.
 - e. Desired pressure range is 40/60 psig (minimum/maximum).
 - f. Booster pump capacity is 110 gpm at 40 psig and 55 gpm at 60 psig.
 - g. Booster pump capacity is 96 gpm at 50 psig $[(P_1 + P_2)/2]$ as determined from the manufacturer's pump curve.
2. The pump cycling will be limited to no more than six cycles per hour.
 3. Minimum water seal of 6 inches is required.
 4. Pertinent data summarized:

$$P_1 = 60 \qquad P_2 = 40 \qquad Q_p = 96 \qquad N_c = 6$$

5. Select a trial tank diameter of 42 inches. Using Table 9-3, the multiplying factor, MF, is 1.10 (by interpolation between the 36-inch and 48-inch tank sizes).
6. Substituting these values in the horizontal tank equation, Equation 9-2,

$$V_t = \frac{P_1 + 14.7}{P_1 - P_2} \times \frac{15 Q_p (MF)}{N_c}$$

$$V_t = \frac{60 + 14.7}{20} \times \frac{15 (96) (1.10)}{6}$$

$$V_t = 986 \text{ Gallons}$$

This is the minimum volume that will satisfy the 6-inch seal-depth requirement for a 42-inch diameter vessel. The tank selected from commercial charts will need to be equal to or greater than this volume.

7. A commercial tank table (see Table 9-2) shows there is a 42-inch tank with a volume of 965 gallons. This volume is close to the required 986 gallons, but it will not give a 6-inch water seal under the operating conditions stipulated. Therefore, if a tank with a 42-inch diameter is to be used, the next larger tank of 1,037 gallons is the one to select.

If a 48-inch diameter tank had been selected, a minimum volume of 968 gallons would be calculated. For this example, Table 9-2 shows a 994-gallon tank is available and acceptable. Note that the 48-inch tank would be about four feet shorter than the 42-inch tank. That may be an important consideration when placing a tank in limited space.

Chapter 10: General Water Treatment

10.0 Introduction

Effective and reliable water treatment is essential to protect public health and promotes consumers' confidence in the water they receive. This chapter includes general information on treating groundwater, seawater, and surface water. Because there are many unique aspects and regulatory requirements associated with the design of surface water treatment facilities, we provide detailed guidance on surface water treatment in Chapter 11.

Regulation describes enforceable drinking water standards as treatment techniques, action levels, or maximum contaminant levels (MCL). These standards form the minimum treatment objectives for any water treatment design. Consumer and water system expectations may exceed minimum regulatory requirements. As such, we encourage design engineers to develop designs that focus on providing a greater level of public health protection than just meeting regulatory standards. Providing this higher level of public health protection is called optimization. Voluntary programs that focus on optimized treatment include the AWWA Partnership for Safe Water and EPA Area Wide Optimization Program. These and similar programs adopted in Washington state have developed water quality optimization goals related to [arsenic](#), disinfection, and [surface water](#) treatment.

Public notification that explains potential health risks to consumers may be required when treatment disruptions occur (WAC 246-290-71001). When evaluating water treatment alternatives, design engineers should consider the full range of source water characteristics, availability of skilled operators, capital and operational costs, and water system acceptance of the treatment technology.

Considering these factors, alternatives such as consolidating with a nearby system, improving source water protection, or abandoning and replacing the contaminated source, often are better long-term approaches to protect public health than constructing a treatment facility. If treatment is the best long-term solution, we structured this chapter to help design engineers select and design a treatment process that is appropriate for the community's needs and resources, protects public health, and supports consumer confidence in the water system.

The overall structure of the chapter is as follows:

- Alternatives Analysis (Section 10.1)
- Treatment Technologies (Section 10.2) including:
 - Disinfection
 - Fluoridation
 - Corrosion Control
 - pH Adjustment
 - Chemical and Radiological Contaminants
- Predesign Studies (Section 10.3) including pilot studies
- Project Reports (Section 10.4) including identifying
 - Design Criteria
 - Process Control -Monitoring, Instrumentation, and Alarms
 - Start-up, Testing Procedures and Operations
- Construction Documents (Section 10.5)
- Treatment Chemicals (Section 10.6)
- Cross-Connection Control for Water Treatment Facilities (Section 10.7)
- Water Treatment Plant Wastewater Disposal (Section 10.8)
- Placing a Water Treatment Plant into Service (Section 10.9)

The water-treatment design process usually involves more steps than designing reservoirs, pump stations, and other types of projects. Figure 2-3 outlines the general design and review process for water treatment projects. In most cases, the design process begins with an assessment of treatment alternatives.

10.1 Alternatives Analysis

A water treatment facility is a major capital investment with high life-cycle costs and a potential risk to the public if the treatment processes fail to operate as intended. Therefore, the engineer **must** evaluate all appropriate and applicable alternatives, and justify the selected option in reports submitted to DOH for approval (WAC 246-290-110(4)(c)).

This chapter includes information design engineers can use to screen potential treatment alternatives prior to undertaking an in-depth analysis. The engineer should cover the following items in the analysis of alternatives and consult detailed guidance in professional references (AWWA/ASCE 2012a; Kawamura 2000b):

- Current and future capacity needs.
- Source water quality.
- Secondary impacts of treatment.
- Operations and maintenance considerations.
- Waste disposal and management.
- Life cycle costs.
- Site considerations.

Point-of-use (POU) and point-of-entry (POE) treatment is not a viable option to comply with drinking water standards in Washington. We limit the use of POU and POE treatment because their application is incompatible with existing regulatory requirements (WSDOH 2007). A limited exception to this restriction applies to noncommunity water systems that use a POE treatment device to treat all the water entering a single-building water system.

10.1.1 Source Water Quantity

The finished water quantity objectives are tied closely to the water system’s expectations of future capacity requirements. See Chapter 4 for details on estimating future water system capacity needs. Design engineers should clearly define future water supply expectations before beginning preliminary evaluation of water supply and treatment alternatives.

The safe yield of any potential water source is the quantity of water—annual, seasonal, and daily—reliably available to the treatment facility. Water rights are another limiting factor. See Chapter 5 for recommendations on establishing an appropriate value for a supply’s safe yield.

The design engineer should carefully consider the efficiency of any proposed treatment process against supply limitations and expected supply needs. Some water treatment processes, especially adsorption and filtration processes, need to be backwashed periodically or otherwise regenerated. Engineers need to consider the amount of water the treatment process requires to backwash, regenerate, rinse, and/or filter to waste when determining the maximum daily treatment capacity and raw water supply requirements.

10.1.2 Source Water Quality

Water systems **must** use the highest quality sources feasible (WAC 246-290-130(1)). Source water and finished water quality objectives form the basis for selecting treatment process alternatives for evaluation. The extent and availability of source water data may

affect preliminary screening of alternatives and the duration of the predesign study. We recommend that the design engineer contact one of our [regional offices](#) to discuss source water monitoring needs in light of available source-water quality data. The design engineer should collect the data necessary to evaluate the efficacy of viable treatment technologies.

Engineers can use a limited source water sampling program to characterize groundwater wells. However, we caution against relying on a single source-water sample because doing so may fail to reveal important changes in water quality over the course of a year. For example:

- Nitrate in groundwater may fluctuate seasonally due to rainfall, irrigation practices, and other land use practices.
- Arsenic concentration in groundwater supplies may vary due to seasonal changes in aquifer level.
- Determining the potential for disinfection byproducts associated with addition of chlorine in coastal groundwater may require analysis over a period of months due to seasonality. An extended suite of unregulated water quality parameters such as ammonia, bromide, total organic carbon, dissolved organic carbon, and chloride could cause byproducts.

Design engineers should consider an extended source water-sampling program to characterize surface water. Surface water quality is highly variable due to changing weather conditions, primarily rainfall patterns and snowmelt conditions. Chapter 11 (Section 11.1.3) provides guidance on source water sampling in support of evaluating surface water. Appendix F provides guidance on groundwater treatment-process alternatives.

10.1.3 Secondary Effects of Water Treatment

Water systems **must** review how proposed projects could potentially affect water quality in the distribution system (WAC 246-290-110(4)(d)). Source changes, or a new or significantly modified treatment process can affect distribution system water quality. These water quality effects could:

- Release accumulated organic and inorganic contaminants from pipe walls.
- Increase corrosion of metals.
- Influence the ability to maintain a disinfection residual (Taylor et al. 2005; Kippin et al. 2001).

Design engineers should identify how the water system will address such issues. Common approaches include:

- Bench scale studies.
- Pipe loop studies with new or existing distribution system materials.
- Enhanced monitoring and flushing programs.

Design engineers **must** specifically address how a change in treatment may affect compliance with the Lead and Copper Rule (40 CFR 141.81(b)(3)(iii); 141.86(d)(4); and 141.90(a)(3)). Some treatment changes that could increase corrosivity, make lead and copper more soluble, and cause other distribution system issues include:

- **Introducing a disinfectant.** Disinfectants can affect corrosivity, metal release, or both (Schock and Lytle 2011). For example, the initial introduction of chlorine can increase the release of copper (Stone et al. 1987). Corrosion rates of both mild steel and copper were found to be higher in the presence of free chlorine than in its absence (Pisigan and Singley 1987).
- **Changing residual disinfectant.** Changing the type of residual disinfectant can change the oxidation-reduction potential within the distribution system. This change can increase the risk of destabilizing pipe scales and the release of inorganic compounds. For example, switching from free chlorine to chloramine as a residual disinfectant can lead to significant lead release (Edwards and Dudi 2004; Boyd et al. 2008).
- **Switching coagulant chemicals.** Changing coagulants can increase the chloride to sulfate mass ratio, causing an increase in lead release (Edwards and Triantafyllidou 2007; Nguyen et al. 2010).
- **Installing additional treatment.** For example, installing ion exchange can change the pH, alkalinity, and chloride-to-sulfate mass ratio increasing lead and copper release at the tap (Nguyen et al. 2010).

We may require water systems that change treatment or introduce a new source of supply to complete additional rounds of lead and copper tap sampling (40 CFR 141.86(d)(4)(vii)).

10.1.4 Operations and Maintenance Considerations

While analyzing treatment alternatives, the design engineer should consider:

- **Expected operational capability of the water system.** This depends on the system's size. Smaller water systems often can't provide the same level of operational capability as large water systems. Engineers should select technology

appropriate for the anticipated level of expertise, time, and resources the water system will devote to operating the treatment facility.

- **Operator certification.** Water systems **must** be able to meet certification requirements that apply to the proposed treatment technology (WAC 246-292-050). The design engineer should make a preliminary determination of the operator certification level for any proposed treatment facility using DOH's [Purification Plant Criteria Worksheet](#). Include operator staffing for multiple shift operations as appropriate.
- **Plant staffing.** The design engineer and public water system should work together with an experienced certified water treatment plant operator to estimate staffing needs. Staffing needs will vary depending on the size, complexity, and degree of treatment process automation. See Section 10.4.3 for additional information.
- **Operator safety.** Design engineers should minimize, to the extent practical, the use of hazardous materials (caustic soda, gaseous chlorine, and acid), confined spaces, and fall hazards.
- **Reliability and ease of operation.** Some treatment processes are simpler and inherently more reliable than others and require less work from operators. Engineers should consider treatment process stability and complexity, especially for smaller systems with part-time or contract operators.

10.1.5 Treatment Plant Waste Disposal

Water treatment plants that remove contaminants will have backwash water that needs to be disposed of properly. The Department of Ecology is the lead permitting agency for all water treatment plant wastewater discharges such as sludge, backwash water discharged to waste, ion exchange waste streams, and membrane reject water. Most water treatment plant waste discharges are permitted under either a National Pollutant Discharge Elimination System (NPDES) permit (general or individual), or a state waste discharge permit.

Water systems developing water treatment proposals should evaluate waste-product issues early because they could significantly affect the cost or feasibility of a proposed approach or technology. See Section 10.8 for detailed information on waste disposal considerations.

10.1.6 Life Cycle Cost Analysis

Designers **must** include estimated capital and annual operating costs in the project report for any proposed treatment project (WAC 246-290-110). Preliminary cost estimates should have the detail and accuracy water systems need to make decisions

about treatment system alternatives. Preliminary construction cost estimates should approach an accuracy of plus-or-minus 30 percent (AWWA 2012b).

Capital costs: Location, capacity, site constraints, water system hydraulics, and source water quality all affect capital costs. They can vary significantly from facility to facility. Engineers can sometimes use cost curves to develop preliminary construction costs for specific treatment processes and then adjust them for inflation and local conditions. Engineers can also use price quotes from equipment manufacturers, local construction experience, and information from similar projects to develop preliminary construction costs.

Operations and maintenance costs: A water treatment facility's operations and maintenance (O&M) costs include labor, power, maintenance, repair, supplies, and services. Engineers can prepare preliminary O&M cost estimates with methods similar to those used for construction costs. However, lack of published data may make detailed component cost assessments necessary to evaluate alternative treatment methods for small water systems.

10.1.7 General Water Treatment Plant Site Considerations

Water treatment plant designs **must** comply with state or locally adopted building, mechanical, electrical, and land use codes (WAC 246-290-200(b)). The contents of these codes, not to mention local ordinances, exceed the scope of this manual. Overall, you should review locally adopted codes and ordinances that could affect the siting and design of a treatment facility in a project report. These considerations include, but are not limited to:

- **Zoning compliance, building code compliance, and community acceptance.** Noise can be an issue for treatment plants located near parks or residences. The maximum permitted sound level can be as low as 45 dBA in residential areas at night (WAC 173-60-040).
- **Operator access, equipment maintenance, and safety.** The pumps and other mechanical equipment need periodic maintenance. As such, the treatment plant design should make it easy to inspect, operate, and maintain the equipment:
 - Beware of creating permit-required confined spaces. Treatment plants in below grade vaults or other permit-required confined spaces (defined in Chapter 296-809 WAC) can create operations and maintenance issues.
 - Provide adequate space around mechanical equipment and electrical equipment. We recommend at least 36 inches of clearance between piping, pumps, and other mechanical equipment. Electrical codes govern the minimum clearance in front of electrical panels; these clearances are at least

36 inches and can be 60 inches or more for high voltage panels (Sanks et al. 1998; AWWA/ASCE 2012f).

- Facilitate removing and installing heavy valves and equipment. Any piece of equipment that weighs more than 100 pounds should be accessible by crane or other lifting assistance. Other means of access include large doorways or roof hatches to facilitate removing heavy equipment directly into a truck. Areas where the operator will walk or perform maintenance should be clear of overhead obstructions to a height of at least 7 feet (Sanks et al. 1998).
- Hearing protection and other measures to protect people in the treatment plant is required when the noise exceeds 85 dBA (Chapter 296-817 WAC).
- **Geotechnical engineering field investigations including:**
 - Site drainage
 - Soil type and soil-bearing strength
 - Groundwater table elevation
 - Soil stability, liquefaction, slope failure analysis
- **Electrical power supply**
 - **Reliability:** Engineers should assess the reliability of the power supply and the need for standby generators. See Section 5.11.1.
 - **Sizing:** While evaluating where to site water treatment facilities engineers should consider the capacity of the local electrical distribution system.

10.1.7.1 Natural Hazard Considerations

Natural disasters could damage treatment plants to the point they fail to operate. Engineers should design and locate treatment plants to minimize vulnerability to damage from:

- Avalanches
- Earthquakes
- Floods
- Landslides
- Tree falls
- Tsunamis
- Windstorms
- Wildfires

To meet state and local requirements, engineers **must** address geologic risk (seismic and unstable slopes) when designing treatment plants (WAC 246-290-200). The state

Department of Natural Resources has [geologic hazard maps](#) that identify seismic and other natural hazards.

Engineers should prioritize making treatment plants that serve water for essential services earthquake resilient, so that treatment plants remain functional after seismic events. Essential services include medical facilities; power plants; fuel refining, storage, and distribution facilities; food production, storage, and distribution facilities; emergency response command and communication centers; and emergency shelters. You should follow the requirements in ASCE 7 to design earthquake resilient treatment plants. And, the water system should have an onsite emergency power source or be able to operate with a portable emergency power source (ASCE 7).

You can reduce or mitigate seismic risk by:

- Being aware of permanent ground displacement or intense ground shaking (in fault zones) that could affect treatment plant facilities and design those facilities to accommodate those hazards.
- Bracing and/or anchoring treatment plant piping, motor control centers, cranes and other equipment needed for treatment operation.
- Anchoring chemical containers used for treatment and water quality testing, so they do not spill.
- Designing for seismically generated waves in treatment basins that may damage submerged or partially submerged equipment and baffles. Damaged equipment or baffles may sink to the bottom of the basin and jam automated sludge scraping equipment.
- Using flexible couplings on pipelines connected between elements that may move differentially.

Various design guidelines highlight the multiple seismic vulnerabilities of piping and large mechanical equipment in some treatment plants (ALA 2002; ALA 2004). In areas with the potential for significant ground motion, you may need to seek the services of a professional qualified to assist in the design of pipe bracing, equipment support, and other aspects of design.

10.1.8 Variances

Under a set of very specific criteria, a water system may qualify for a variance from compliance with certain drinking water standards. A variance allows a water system serving fewer than 10,000 people to install treatment and be considered in compliance while at the same time exceeding a drinking water standard. DOH will not consider

variances for compliance with the coliform MCL, a treatment technique requirement, or any surface water treatment requirement (WAC 246-290-060(2)).

To date, we haven't granted a variance from a primary MCL or treatment technique. A small system may receive a variance under a particular national primary drinking water regulation only if:

1. The contaminant wasn't regulated prior to January 1, 1986 (See 40 CFR 142.304).
2. EPA identified an applicable variance technology.
3. The water system actually installs, operates, and maintains the specific technology in question.
4. The water system provides extensive public notification as described in federal regulations (See 40 CFR 142.308).

10.2 Treatment Technologies

This section and the tables at the end of this chapter provide information about many of the more common treatment technologies for:

- Disinfection (Section 10.2.1; Table 10-7)
- Disinfection byproducts control (Section 10.2.2; Table 10-11)
- Fluoridation (Section 10.2.3)
- Corrosion control (Section 10.2.4; Table 10-8)
- pH Adjustment (Section 10.2.5)
- Inorganic chemical (IOC) removal (Section 10.2.6; Table 10-9)
- Volatile organic chemical (VOC) and synthetic organic chemical (SOC) removal (Section 10.2.7; Table 10-10)
- Radionuclides removal (Section 10.2.8)
- Emerging contaminants (Section 10.2.9)

We discuss treatment technologies for surface water in Chapter 11.

Instead of removing a contaminant, it may be appropriate to blend sources to achieve compliance with a drinking water standard. DOH considers blending a form of treatment. We require a project report and construction documents for any blending project. The engineering analysis for blending should include:

- **An analysis of the water quality** from the sources under consideration, including any seasonal water quality changes that could affect the blending strategy.

- **A description of the blending strategy**, including calculations of flow and finished water quality, monitoring, controls, and alarm or shutdown conditions.
- **A preliminary design and schematic** that shows piping, control valves, monitoring points, and other important features.

Water systems usually use blending to address inorganic and organic contaminants. In some cases, they use both blending and physical treatment to address contaminants of concern. Water systems cannot use blending to address microbial risks.

Most of the treatment technologies in Tables 10-7 through 10-11 are widely used with established control and monitoring strategies. For alternative technologies without such extensive design and operating experience, we usually require more analysis and pilot testing to establish the design parameters, process control, and technology-specific monitoring strategies. Given the additional engineering and analysis that may be required, design engineers should check with one of our [regional offices](#) before proceeding with an alternative technology.

10.2.1 Disinfection

The design approach to disinfection treatment will differ depending on the intended purpose of the application. In some cases, engineers use primary disinfection, which addresses microbial risk in the source water. In other cases, engineers use secondary disinfection, which addresses microbial risks in the distribution system. Some systems, including all surface water systems, **must** provide both primary and secondary disinfection treatment (Chapter 246-290 WAC, Part 6; WAC 246-290-250(4)); and WAC 246-290-451). Disinfection requirements for surface water sources are in Chapter 11.

Disinfection is the most common form of potable water treatment in Washington. Water systems treat more than half of the state's 8,000 Group A drinking water sources with a disinfectant. Of those, more than 90 percent are treated with hypochlorite, commonly called free chlorine. For that reason, this section focuses on free chlorine used as a primary or secondary disinfectant. Water systems also use free chlorine as an oxidant in processes that remove inorganic contaminants. See Section 10.2.1.4 for information on the use of chlorine as an oxidant.

Adding or changing a chemical disinfectant will change water chemistry and could generate secondary effects beyond DBP formation. These secondary effects may cause significant water quality changes in the distribution system, such as release of corrosion byproducts due to changes in oxidation-reduction potential. See Sections 5.3 and 10.1.3 for further details.

Additional information on disinfectants is in Table 10-7. Performance criteria for groundwater and seawater disinfection are in Chapter 246-290 WAC, Part 5. Information specific to primary and secondary disinfection of surface water supplies is in Chapter 11.

10.2.1.1 Source Water Quality

Design engineers **must** evaluate source water quality in the design of any primary or secondary disinfection system (WAC 246-290-110). Some water quality parameters, such as iron, manganese, natural organic matter, dissolved organic carbon (DOC), ammonia, and sulfide exert a chlorine demand. If there is natural ammonia in the source water, it can cause multiple challenges including difficulty maintaining a free chlorine residual and taste and odor problems. Chemical disinfectants such as ozone, chlorine, chlorine dioxide, and chloramines produce disinfectant byproducts (DBPs). Some source waters, especially those with high concentrations of natural organic matter, can form DBPs at levels of public health concern. In addition to understanding chlorine or other disinfectant demands of the source water, design engineers should assess the potential for disinfectant byproducts to form when adding or changing a chemical disinfectant.

When designing treatment that includes adding chlorine as a disinfectant or oxidant, engineers should analyze the following source water-quality parameters:

- Ammonia: To assess the efficacy of chlorine as a disinfectant and oxidant.
- DOC: To assess the potential to form HAA and THM. We found values less than 1.0 mg/l of DOC unlikely to result in exceedances of the TTHM MCL.
- Bromide and chloride (in coastal groundwater sources): To assess brominated HAA and THM formation. The highest proportions of brominated HAA and THM formation can be expected from sources with relatively low DOC concentrations and higher [Br⁻] levels (i.e., high [Br⁻]/[DOC] ratios).

We found that results from total formation-potential tests for THMs and HAA5 do not correlate with regulatory TTHM and HAA5 test results in distribution systems studied at length. Therefore, we recommend that design engineers use discrete DOC and bromide test results when assessing future DBP formation.

For guidance on source water information useful in the design of a new chlorination system, see Appendix F.1.

10.2.1.2 Primary Disinfection of Groundwater Sources

Unanticipated environmental conditions, or other factors beyond the water system's control, may adversely affect source water quality at any time. Engineers should account for primary disinfection in the design of each groundwater source. Retrofitting an

operational source, pump house, or transmission facilities after-the-fact can be expensive and disruptive to water system operations.

If we determine that a groundwater source is vulnerable to microbiological contamination or water quality data confirms *E. coli* contamination, then a water system **must** provide continuous primary disinfection of the source (WAC 246-290-451 or -453, respectively).

The design of primary disinfection with free chlorine **must** provide a CT equal to or greater than 6 without exceeding the total chlorine maximum residual disinfectant level (MRDL) of 4 mg/L. Calculate the CT value by multiplying the free chlorine residual concentration ("C," in mg/l) by the chlorine contact time ("T", in minutes). CT6 applies where the treated water temperature is greater than or equal to 10°C and the pH is in the 6 to 9 range. If the temperature is less than 10°C, the minimum required CT is 8. For groundwater outside the range of 6 to 9, contact your regional office.

For primary disinfection with other disinfectants, see the CT requirements for 4-log virus inactivation in Section 10.2.1.5 and Table 10-1.

Calculate contact time (T) at peak hourly flow between the point of chlorine injection and the residual chlorine monitoring location. The residual disinfectant monitoring location **must** be at or before the first customer (WAC 246-290-451(6)). Assessing the contact time ("T," in minutes) can be a challenging part of the design process because contact time depends on the baffling efficiency of the tanks, pipes, and reservoirs through which the water flows. Detailed information on estimating the baffling efficiency of various structures and contact time is in Chapter 11. For additional guidance on free chlorine disinfection, refer to Appendix F.1; on ozone disinfection, refer to Appendix F.5; and on UV disinfection, refer to Appendix I.

10.2.1.3 Secondary Disinfection of Distribution Systems

Secondary disinfection means adding a chemical disinfectant at a source or pump station to maintain a distribution system residual. Water systems use secondary disinfection to establish microbiological control throughout the distribution system. If the treatment is limited to secondary disinfection, design and operational monitoring requirements for CT6 and 4-log don't apply. However, engineers **must** include considerations for disinfection residual monitoring in the distribution system in their design, so the water system can demonstrate maintenance of a detectable residual in all active parts of the distribution system (WAC 246-290-451(7)).

10.2.1.4 Monitoring Plans

Monitoring is a key part of any disinfection system design. Delivering water continuously treated with free chlorine, chloramines, chlorine dioxide, or ozone triggers disinfection residual monitoring requirements (WAC 246-290-300(6)(c); -451; -453). If the water system will add a chemical disinfectant to a source, the design **must** include pretreatment and posttreatment source sample taps for monitoring water quality (WAC 246-290-300(3)(h); -451(6)(c)). A DBP monitoring plan should accompany the new disinfection system design.

Adding a disinfectant or changing a disinfection practice also can affect coliform monitoring practices. A system adding a disinfectant **must** measure and record the residual disinfectant concentration in samples collected at the same time and location that it collects routine and repeat coliform samples (WAC 246-290-451(9)). Adding a disinfectant may change a system's contingency planning for detection of *E. coli*. For this reason, every water system **must** update their coliform monitoring plan as part of any change in disinfection practice (WAC 246-290-300(3)(b)). Refer to our coliform monitoring plan guidance (DOH [331-036](#) and [331-240](#)) for additional information.

Chlorine or another disinfectant used solely as an oxidant can affect the water quality served to customers. Design engineers **must** still address issues such as:

- Disinfection byproducts monitoring.
- Monitoring and maintenance of chlorine residual in the distribution system (WAC 246-290-451(7) and (9); -300(6)).

10.2.1.5 Disinfection of Seawater or Brackish Water Source

Open seawater sources **must** be treated to a minimum CT6 prior to the first connection. (WAC 246-290-451(4)). This level of primary disinfection provides an additional barrier in case the integrity of a membrane or another water system component is compromised. Refer to our design checklist for desalination of seawater sources in Appendix F.6.

Design engineers should assess the requirement for primary disinfection of a saline well treated with reverse osmosis the same as any other groundwater supply. Considerations should include:

- Construction of the well.
- Degree of wellhead protection.
- Aquifer characteristics.
- Bacteriological history of the source.

10.2.1.6 Alternative Disinfectants

Water systems can use chlorine dioxide, chloramines, ozone, and ultraviolet (UV) disinfection instead of, or along with, chlorine to address microbial risks, though each disinfection approach has limitations. We strongly discourage the use of iodine; it has very limited permitted use as a drinking water additive. See [Policy F.01](#).

For primary disinfection of groundwater, free chlorine is usually a more practical choice than alternative disinfectants based on the required CT values compiled in Table 10-1. This table also includes the maximum residual disinfectant levels (MRDLs) for these disinfectants. Initial design references for these alternative disinfectants are available elsewhere (USEPA 1999; USEPA 2006; Ten State Standards 2012).

Table 10-1
Disinfection Requirements

Disinfectant ^{1,2}	CT required for 4-log virus inactivation		MRDL (mg/L)
	At 5°C (mg-min/L)	At 10°C (mg-min/L)	
Chlorine	8	6	4.0 as Cl ₂
Chloramines	1988	1491	4.0 as Cl ₂
Chlorine Dioxide	33.4	25.1	0.8 ³
Ozone	1.2	1.0	Not applicable
UV	186 mJ/cm ²	186 mJ/cm ²	Not applicable

Notes:

1. Chemical disinfection requirements are from Appendix E of the *Guidance Manual for Compliance with the Filtration and Disinfection Requirements for Public Water Systems Using Surface Sources* (USEPA 1990).
2. UV disinfection requirements for viruses are in 40CFR 141.720(d).
3. If a violation of the MRDL for chlorine dioxide occurs, it is a Tier 1 violation requiring public notification as soon as possible, and no later than 24 hours after the violation occurs.

Ozone

Ozone is a very strong oxidant and highly reactive. In drinking water, it is used as an oxidant and for primary disinfection of surface water sources. Because it is so reactive, ozone is not feasible for secondary disinfection, and special materials and equipment are required in the design of ozonation facilities. In addition to monitoring for THMs and HAA5, water systems that use ozone **must** monitor for bromate at the entry point to the distribution system (WAC 246-290-300(6)(b)(iii)). Any water system planning to use ozone should carefully review fire code and worker safety requirements associated with its use. For additional guidance, see Appendix F.5.

Chlorine Dioxide

Chlorine dioxide is a strong disinfectant that may be used for both primary and secondary disinfection. To date, it has had limited use in Washington state. The use of chlorine dioxide involves special monitoring and reporting requirements. The monitoring requirements include daily measurements for chlorine dioxide and chlorite at the entry point to the distribution system (WAC 246-290-300(6)(b)(ii)). There are also special requirements for monitoring chlorine dioxide and chlorite in the distribution system. If the concentration of chlorine dioxide in the distribution system exceeds 0.8 mg/L, consumers **must** be notified immediately (WAC 246-290-300(6)(b)(ii)). Water systems also should notify some end users immediately, such as hospitals, kidney dialysis centers, and customers with fish tanks because they can be especially sensitive to chlorine dioxide and its byproducts.

Chloramines

Chloramines form when free chlorine reacts with ammonia. Monochloramine, the main disinfecting agent, is a weak disinfectant so water systems usually use it solely as a secondary disinfectant. Special concerns associated with using chloramines include the sensitivity of some customers, such as hospitals, kidney dialysis centers, and customers with fish tanks, and the potential for increased corrosion and damage to some materials in the distribution system. See Section 10.1.3 and Table 10-7.

UV Disinfection

In surface water sources, a relatively low dose of UV disinfection effectively inactivates *Giardia lamblia* and *Cryptosporidium*. The UV dose required to inactivate viruses is significantly higher, which limits the use of UV as a primary disinfectant for groundwater. UV reactors also do not provide a residual disinfectant. Appendix I includes additional guidance on applying UV disinfection.

Dichlor and Trichlor

Dichloroisocyanuric acid (dichlor) and trichloroisocyanuric acid (trichlor) are strong biocides and oxidizers produced in granular or tablet (solid) form. When dissolved in water they produce hypochlorous acid (free chlorine) and chloroisocyanuric acid (Wahman 2018). Residual chloroisocyanuric acid, interferes with standard methods for analyzing free chlorine. This interference overstates the actual level of free chlorine. As a result, we will not approve designs that use dichlor or trichlor as the source of free chlorine for primary or secondary disinfection.

10.2.2 Disinfection Byproducts

Disinfection byproducts (DBPs) can form whenever a chemical disinfectant is added to drinking water. Therefore, all community and nontransient noncommunity (NTNC) water

systems that distribute water to which a disinfectant has been added **must** monitor for DBPs and have a DBP monitoring plan (WAC 246-290-300(6)). All affected water systems **must** monitor for total trihalomethanes (TTHMs) and the five currently regulated haloacetic acids (HAA5) with special monitoring requirements for water systems that use chlorine dioxide or ozone (WAC 246-290-300(6)(b)). If a DBP MCL violation occurs, corrective action including removal of DBP precursors and/or operational changes (treatment, storage, distribution) to limit DBP formation will be required (WAC 246-290-320).

Certain unregulated water quality parameters can significantly influence the potential for DBP formation following chlorination. Dissolved organic carbon (DOC) in source water is the primary factor affecting DBP formation in chlorinated groundwater. Engineers should measure the concentration of DOC in source water over multiple seasons to assess the likelihood of excessive HAA and THM concentration in water treated with chlorine. Ammonia exerts a strong demand for free chlorine. Engineers should measure bromide and chloride in coastal groundwater sources when they consider adding chlorine.

Water systems may be able to limit DBP formation by minimizing the contact between chemical disinfectants and DBP precursors such as natural organic matter. If DBP results are of concern, design engineers and water systems should initially consider simple operational changes. These operational changes include:

- **Modifying disinfection practices:** Filtration removes DBP precursors. Therefore, adjusting pre- and post-filtration practices can reduce the formation of DBPs.
- **Decreasing water age or stagnation:** In most cases, DBPs gradually increase in the distribution system as water ages. To minimize water age and decrease stagnation, use manual and automatic flushing, employ reservoir mixing, and adjust storage volumes.
- **In-reservoir aeration:** Aeration processes, including in-reservoir aeration, can remove some THMs. In-reservoir aeration usually involves retrofitting the reservoir inlet with spray nozzles, and possibly other modifications. With aeration, there will likely be some loss of chlorine residual, so downstream adjustments may be needed.

Some of these changes may require the engineer to submit a project report and construction documents. Please contact your regional office to determine whether a submittal is required.

If operational changes are insufficient to address DBP issues, the engineer may need to take other actions. Common treatment technologies used to minimize DBP formation include:

- **Alternative oxidants and disinfectants:** If the system requires an oxidant, engineers can use oxidants such as permanganate, air, and oxidizing media that do not form DBPs instead of free chlorine. If disinfection is required, engineers can evaluate alternative disinfectants such as monochloramine, chlorine dioxide and UV disinfection. Some changes in disinfection practice can cause increased lead and copper release. See Section 10.1.3. We cover alternative disinfectants in detail in Section 10.2.1.6.
- **Granular media filtration:** Engineers can use some types of filtration to remove natural organic matter. These processes include rapid-rate filtration to treat surface water, and pressure filtration to remove arsenic, iron, and manganese. In these processes, the ability to remove DBP precursors depends on the dose of aluminum or iron-based coagulants (or amount of naturally occurring iron), polymer addition, and physical parameters, such as filtration rate, media type, and depth.
- **Biological filtration:** Slow sand filtration, which combines biological and physical or chemical processes, and biologically active-rapid rate filtration, which enhances the biological activity in rapid rate filters, can provide DBP precursor removal that may be greater than purely physical and/or chemical removal processes. Low temperatures reduce biological activity, so engineers may need more extensive pilot testing to assess the biological aspects of the filtration process and resulting effects on DBP removal.
- **Membrane filtration:** Low-pressure membrane filtration, such as microfiltration and ultrafiltration, alone cannot effectively remove DBP precursors. However, adding a coagulant such as aluminum chlorohydrate (ACH) prior to filtration will enable the filters to effectively remove DBP precursors. You will need to perform pilot testing to determine the appropriate coagulant and dose. Too much coagulant can lead to excessive membrane fouling. Too little coagulant can result in poor DBP precursor removal and other operational issues.
- **Granular activated carbon (GAC):** GAC removes dissolved organic carbon (DOC), which is a precursor to the formation of DBPs. Engineers usually install GAC in a contactor before or after filtration, or as a cap on rapid-rate filters. You will need to perform pilot testing to determine how long the GAC media will be effective before exhaustion, and the associated operational costs. As long as GAC remains effective at removing DOC, few DBPs should form. If you use GAC to treat DBPs, plan weekly field tests to check UV 254 absorbance. Your UV 254 absorbance measurement is a surrogate for the presence of DOC and the on-

going effectiveness of GAC to remove DOC. An increase in UV 254 absorbance means the carbon filter is exhausted and DBP levels will likely increase. If you use GAC as filtration media, you also need to perform pilot testing to evaluate its effectiveness in removing pathogens and other contaminants.

- **Powdered activated carbon (PAC):** PAC removes dissolved organic carbon (DOC), similar to GAC. Systems feed PAC prior to filtration and remove it in the filtration process. Key initial design parameters include the PAC characteristics, effective dose, and contact time. Engineers will usually need bench and pilot testing to determine appropriate design parameters.
- **Anion exchange:** To remove DBP precursors, engineers can consider fixed-bed anion exchange systems or recirculating ion-exchange systems, such as MIEX®. Fouling of the ion exchange resin over time, pH effects, and waste disposal of the salt brine used to regenerate the ion exchange resin are common design concerns.

For more information on these and other technologies, see Table 10-11 at the end of this chapter. EPA also has several manuals on DBP removal and monitoring (USEPA 1999a; USEPA 1999b; USEPA 2001).

10.2.3 Fluoridation

DOH supports community water fluoridation as a sound, population-based public health measure. However, local communities decide whether their public water system adds fluoride.

The optimal treated water fluoride concentration is 0.7 mg/L. Water systems that fluoridate **must** maintain a fluoride concentration between 0.5 mg/L and 0.9 mg/L in the distribution system (WAC 246-290-460). This requirement ensures fluoridation is tightly controlled, effective, and reliable.

Technologies used for fluoridating drinking water include liquid and dry feed systems. This manual does not contain specific recommendations for fluoridation technologies. You will find such recommendations in references, such as *Water Fluoridation: A Manual for Engineers and Technicians* (Reeves 1986), the *Recommended Standards for Water Works* (Ten State Standards 2012), and *Water Fluoridation Principles and Practices* (AWWA 2016). Appendix F.2 includes a checklist for the design of sodium fluoride saturators. We do not require pilot studies for fluoridation facilities.

Fluoride design recommendations:

- The maximum chemical feed rate attainable from the chemical metering pump(s) or feeder(s) should not exceed twice the recommended dose.
- There should be two interlocks on any fluoride feed equipment to ensure that it does not start until after water begins flowing past the fluoride feed point.
- For liquid fluoride chemical feeders, water systems should install antisiphon check valves in the solution line at two locations: 1) at the pump head, and 2) at the point of injection.
- Where applicable, the water system should clearly label the plugs or fill ports for fluoride liquid storage tanks. They should be a unique size or shape to reduce the risk of inadvertently adding any other chemical to a fluoride storage tank.
- The engineer **must** equip the potable water connection to any fluoride saturator with either an air gap or a properly installed and tested reduced pressure backflow assembly (WAC 246-290-490(4)(b)).
- The design engineer should verify the fluoride feed-rate design assumptions during the start-up, testing, and operation period.
- Prior to start-up, operators of fluoridated systems should receive at least six-hours of DOH-approved "fluoridation basics" training for water operators.

See Section 10.6 for additional information on safe chemical handling and storage.

10.2.4 Corrosion Control

Water systems exceeding the lead or copper action level and all large water systems (serving more than 50,000 people) **must** implement optimal corrosion control treatment (chapter 246-290 WAC and 40 CFR 141.80 through 141.90). Large systems **must** conduct a corrosion control study (40 CFR 141.81(d)). Systems serving fewer than 50,000 people can submit a corrosion-control recommendation report unless we directed them to complete a corrosion control study. Engineers can use the *Optimal Corrosion Control Treatment Evaluation Technical Recommendations for Primacy Agencies and Public Water Systems* (USEPA 2016) to identify appropriate technologies for water systems that exceed the lead or copper action level. Water systems that exceed an action level should contact one of our [regional offices](#). Table 10-8 cites commonly used corrosion control technologies and identifies issues associated with them.

DOH recommends that design engineers use pipe-loop or other pilot-scale work to evaluate actual corrosion or corrosion rates using a proposed treatment approach. We also recommend that you use bench or pilot-scale testing for selected technologies (aeration, calcite contactors, and pH adjustment) to verify that a proposed design dose-

rate will meet treatment objectives (target pH or alkalinity). These studies may be oriented toward ensuring that target pH or alkalinity goals are met rather than measuring resulting corrosion rates. Some water systems have had difficulty matching full-scale results to bench scale data. Water systems proposing to use aeration or air stripping should conduct a pilot test to confirm the ability of the process to increase the treated water pH adequately.

Many corrosion control approaches include chemical feed facilities to make the treated water less corrosive to distribution, plumbing, and service line materials. As such, the design usually includes protection from treatment chemical overfeed to minimize the risk to public health. See Section 10.6.1 and Table 10-3 for information on design features to decrease the risk of chemical overfeed.

Lime and soda ash feed systems may be operator intensive because of the potential for plugging feed equipment and piping. Engineers should size chemical metering pumps to provide for potential differences in demand, and compare bench scale results to theoretical water chemistry expectations. More detailed guidance on chemical feed systems is in Section 10.6.

See Section 10.1.3 for information on other treatment process changes that can affect corrosion control.

10.2.5 pH Adjustment

In addition to its role in corrosion control treatment, pH effects many other treatment processes. For example, chlorine disinfection is more effective at lower pH. Removal processes for many inorganic chemicals, such as arsenic, iron and manganese, work best within specific pH ranges as discussed in Section 10.2.6. Likewise, performance of coagulation chemicals used in surface water treatment can vary with pH.

EPA established a secondary (aesthetic) standard for pH of 6.5 to 8.5. Lower pH conditions can cause water to have a bitter metallic taste and be corrosive to plumbing materials. High pH can make water feel slippery, giving it an unpleasant taste or causing deposits in plumbing systems.

Most approaches for adjusting pH involve chemical feed facilities to inject an acid or base. Common chemicals used to lower pH are carbon dioxide (gas), citric acid, and phosphoric acid. Common chemicals used to raise pH are lime, sodium carbonate (soda ash) and sodium hydroxide (caustic). All chemicals **must** be used within their ANSI/NSF 60 approved doses (WAC 246-290-220(3)).

Changes in pH (and alkalinity) can affect distribution water quality. Secondary effects of treatment **must** be considered as described in Sections 10.1.3 and 10.2.4.

Strong acids and bases require careful selection, storage, and handling to protect worker safety. For example, a 50 percent caustic solution solidifies at 58°F, which can plug piping and even cause injury if valves or piping fail as a result. For this reason, we recommend using a more dilute solution of 25 percent or less. Section 10.6.2 has more information on chemical storage and handling. When feeding concentrated acids and bases, include design features to lower the risk of chemical overfeed. See Section 10.6.1 for more information.

Effective pH adjustment requires appropriate process control through monitoring, instrumentation, and alarms. Continuous monitoring of pH should be provided upstream of the chemical injection point and downstream after the chemical is completely mixed. Section 10.4.2 has more information on process control.

10.2.6 Inorganic Chemicals

There are primary (health-based) or secondary (aesthetic) water quality standards for more than a dozen inorganic chemicals (IOCs) (chapter 246-290 WAC). The IOCs most frequently detected above their MCLs are arsenic (As), fluoride (F), nitrate (NO₃), iron (Fe), and manganese (Mn). Table 10-9 summarizes treatment options for these contaminants.

Chloride and conductivity are secondary contaminants that may indicate seawater intrusion. Seawater intrusion itself indicates that a source water quantity issues exists. DOH and local health departments may require additional action when seawater intrusion threatens the reliability of the water supply. See Section 5.5.4 for more information on seawater intrusion.

10.2.6.1 Arsenic

EPA established the arsenic MCL of 10 parts per billion (0.010 mg/L) based on chronic health concerns, including carcinogenic and cardiovascular risks. Water systems developing a new well with arsenic over the MCL, or operating an existing seasonal or permanent source exceeding the arsenic MCL on a running annual average, **must** design remedial measures to comply with the arsenic standard (WAC 246-290-310).

Measures may include physical removal, blending, or a nontreatment alternative, such as drilling a new well or connecting to a nearby water system. Engineers should consider nontreatment alternatives first, especially if arsenic in the source exceeds 0.050 mg/L.

Treating arsenic at that high of a concentration can be challenging and expensive. In addition, when the arsenic concentration is that high, a treatment failure can present an acute health risk. The simplicity of operations and availability of qualified operators are key considerations when selecting a long-term solution to arsenic contamination.

It is important to consider raw water quality parameters, such as pH, iron, manganese, ammonia, phosphate and silica when selecting any arsenic treatment technology. Effective treatment depends on arsenic being present as arsenate or As(5), the oxidized form of inorganic arsenic. Effective treatment depends on knowing and addressing how other water quality parameters can affect the treatment outcome. Ammonia, if present, can prevent effective oxidation of arsenic to As(5). Silica, especially in conjunction with pH greater than 8.0, reduces the ability of treatment processes to remove arsenic.

Common arsenic treatment approaches:

- **Adsorbents:** Several iron oxide and other metal-based adsorbents can be used to bind arsenic. Eventually, all the binding sites in the adsorbent are used up and the adsorbent needs to be replaced. The replacement period for adsorbents can vary widely, and can be much shorter than estimates from suppliers because of interference by silica, phosphate and other compounds. Engineers should evaluate adsorbents for the specific source water quality before selecting an adsorbent or detailed design. If the pH of the water is adjusted to increase the effective life of the adsorbent, continuous pH monitoring and looped process control is necessary to prevent the arsenic from being released from the adsorbent. Inadequate evaluation of adsorbents has led to impractically short replacement periods and subsequent abandonment of the adsorbent treatment process.
- **Anion exchange:** Because arsenate (As(5)) is a negatively charged ion at the pH of most natural waters, anion exchange can be used to remove arsenic. Water systems use a salt brine periodically to regenerate the anion resin. One of the key design parameters is the volume of water the anion resin can treat before regenerating the system. Engineers should conduct a pilot test to confirm any estimated volume of water that can be treated before regeneration. Anion exchange treatment also initially decreases the pH and alkalinity of the water, which can make it more corrosive to lead, copper, and other metals. As a result, the design may require corrosion control treatment.
- **Coagulation-Filtration:** For source water with insufficient iron, water systems can add iron and aluminum-based coagulants to the raw water to bind with arsenic for subsequent removal by filtration. For effective treatment, they usually will need to add a preoxidant, such as free chlorine or permanganate, so that

there is at least 20 seconds of contact time prior to coagulant addition. The filtration media, depth, loading rate, and backwash frequency and duration are other key design parameters.

- **Oxidation-Filtration:** For source water with sufficient iron, oxidizing the iron will bind arsenic and remove both iron and arsenic through filtration. The ratio of iron to arsenic necessary for effective treatment is usually at least 20:1 on a mass basis, and may need to be greater than 100:1 in some cases. As with coagulation filtration, the filtration media, depth, loading rate, and backwash frequency and duration are important design parameters.

Additional information about these treatment approaches is in Table 10-9 and guidelines are in appendices F.3, F.4, and F.5.

EPA and the Water Research Foundation (formerly AWWARF) developed many guidance documents that may help you evaluate arsenic treatment alternatives (USEPA 2003; Hoffman 2006). In addition, EPA's [Arsenic Treatment Technology Demonstrations](#) website contains many reports and detailed case studies that can be useful in the design of a treatment system.

10.2.6.2 Nitrate and Nitrite

Nitrate and nitrite are acute contaminants for susceptible individuals (primarily infants less than 12 months old and pregnant women). A single exposure can negatively affect the health of these susceptible individuals. The primary sources for nitrate and nitrite are agricultural activities and septic tank effluent.

Design engineers should explore nontreatment alternatives to resolve nitrate contamination of a groundwater supply, including abandonment of the source and developing an alternate groundwater supply or intertie with an adjacent water system. If there are no feasible nontreatment alternatives, consider the following:

- **Blending:** The mass-balance of nitrate from both sources is the basic design parameter. Because nitrate in groundwater varies over time, water systems should apply a significant factor of safety when determining the mixing rate of two or more sources.
- **Anion exchange:** Because nitrate is a negatively charged ion, anion exchange can be used to remove nitrate. Water systems use a salt brine periodically to regenerate the anion resin. One of the key design parameters is the volume of water the anion resin can treat before regenerating the system. Engineers should use a pilot test to confirm any estimated volume of water that can be treated before exhaustion. Another important design parameter is the concentration of

other ions, which preferentially compete for exchange sites on the resin, such as sulfate. If the water system does not regenerate anion resin in time, preferred ions (i.e. sulfate) will displace less preferred ions (nitrate). This can result in an effect called chromatographic peaking, where the concentration of nitrate in the treated effluent exceeds that in the untreated water. Anion exchange treatment also initially decreases the pH and alkalinity of the water, which can make it more corrosive to lead, copper, and other metals. As a result, the design may require corrosion control treatment. For additional guidance, see Appendix F.11.

- **Reverse osmosis:** Water systems use this treatment process mainly for very small flow applications due to the high cost associated with larger RO treatment systems and the high proportion of reject water. RO treatment rejects most dissolved minerals, thereby changing the conductivity of the water. For that reason, water systems can consider continuous conductivity monitoring as an alternative to frequent nitrate monitoring.

For additional notes about these technologies, see Table 10-9 at the end of this chapter.

Information on nitrate occurrence in Washington and a discussion of treatment and nontreatment alternatives for nitrate is in the DOH guidance document *Nitrate Treatment Alternatives for Small Water Systems* ([DOH 331-309](#)). You can find more information about ways to address nitrate contamination of groundwater in other guidance manuals (Jensen et al. 2012; Seidel et al. 2011).

10.2.6.3 Iron and Manganese

Several contaminants have regulatory standards based on aesthetics, such as taste, color, and staining of plumbing fixtures. Of the chemicals with secondary maximum contaminant levels (SMCLs), iron (Fe) and manganese (Mn) are the two most commonly found in untreated water sources. We recommend that water systems treat each source that exceeds the SMCL for Fe or Mn. Manganese can accumulate in the distribution system and release later during a change in flow or water chemistry. Therefore, current industry guidance recommends that water systems treat source water to avoid exceeding 0.020 mg/L of Mn at entry to the distribution system (Kohl and Medlar 2006).

The requirement to comply with the SMCLs for Fe and Mn varies for new and existing sources and water systems.

- An **existing** water system with other sources that do not exceed the SMCL for Fe and Mn, **shall** provide treatment for a new source that exceeds the SMCL for Fe or Mn (WAC 246-290-130 (3)(g)).

- An **existing** water system with one or more existing sources that exceed the SMCL for Fe and Mn, should submit to DOH:
 - A resolution from its governing board or owner showing that its community or indicate that the proposed new source will not add to the existing water quality problems.
 - Life-cycle treatment cost information.
- A **new** community or **new** nontransient noncommunity water system without active consumers, **shall** provide treatment for a new source that exceeds the SMCL for Fe or Mn (WAC 246-290-320(3)(d)).

Water systems may use an existing emergency source that exceeds a secondary MCL during an emergency without needing an engineering report. Water systems **must** meet other conditions before safely placing an emergency source into service, including prior sampling for acute drinking water contaminants and public notification (WAC 246-290-131).

Iron and manganese frequently occur in groundwater at concentrations above their SMCLs. Most water systems use oxidation combined with filtration as the treatment process to remove iron and manganese from drinking water. Oxidants include air, chlorine, potassium permanganate (KMnO₄), and ozone. Water systems that use ozone or chlorine **must** monitor disinfection byproducts (WAC 246-290-300(6)). Because aeration may not provide sufficient oxidation, KMnO₄ is the oxidant of choice. It is effective over a wide range of pH. The most effective Fe and Mn oxidation and filtration removal occurs at pH 7.5 and above.

Water systems also can use ion exchange technologies to remove Fe and Mn. With these methods, system should take care to ensure that the iron and manganese don't oxidize before application through the exchange media. Fouling of the exchange bed can occur if the system doesn't maintain the iron or manganese in a chemically reduced state.

The design engineer should be aware of water quality characteristics, such as total organic carbon, pH, and competing ions that can adversely affect treatment performance. The limitations of treatment options for iron and manganese are in Table 10-9 and other texts (HDR 2001; Sommerfeld 1999; Faust and Aly 1998; AWWA/ASCE 1990). Additional guidance on iron and manganese treatment is in Appendix F.9 and F.10.

10.2.6.4 Fluoride Removal

Fluoride can naturally occur in source waters at concentrations greater than its primary MCL of 4.0 mg/L. Bone char and activated alumina are the two most common treatment technologies used to remove excess naturally occurring fluoride from drinking water. You can find detailed design guidance for fluoride removal elsewhere (Fawell et al. 2006; AWWA/ASCE 2012b).

10.2.7 Volatile Organic Chemicals and Synthetic Organic Chemicals

A list of treatment technologies acceptable for removing volatile organic chemicals (VOCs) and synthetic organic chemicals (SOCs) is in Table 10-10. In addition to specific technologies, this table identifies selected issues the engineer should consider. In most cases, due to the complexity of treatment processes for specific organic contaminants, the engineer will have to use predesign studies and pilot tests to determine whether a treatment process is appropriate to a particular source.

10.2.8 Radionuclides

There are primary MCLs for radium 226 and radium 228 (5 picocuries/L combined), gross alpha particle radioactivity (15 picocuries/L), beta particles, photon emitters, and uranium (30 ug/L). Naturally occurring radionuclides are associated with granitic and metasedimentary rock and younger sedimentary formations in northeastern Washington.

Water systems **must** use predesign studies and pilot tests to determine treatment and waste disposal options appropriate for their specific situations (WAC 246-290-110(4)). Water systems can remove radium and uranium from drinking water by using properly designed ion exchange treatment processes (Clifford 1999). Reviews of other treatment processes and the waste disposal issues related to them are available elsewhere (USEPA 2006b).

10.2.9 Emerging and Unregulated Contaminants

Currently, there are more than 90 regulated contaminants in drinking water with some contaminants serving as indicators for others. With increasing awareness and improving laboratory detection limits, new water quality contaminants of concern continue to emerge. EPA and other public health professionals are reviewing many of them. Some contaminants have established health advisory limits and may be regulated in the future. Recent examples include cyanotoxins, hexavalent chromium, perchlorate, and perfluoroalkyl substances such as perfluorooctanic acid (PFOA).

While treatment for an unregulated contaminant may not currently be enforceable under federal drinking water regulations, DOH may require a water system with an unregulated contaminant exceeding an established health advisory level to issue public notice and cooperate with us in educating consumers about the health risk. Detection of unregulated contaminants may prompt local health officials, community leaders, and the public to demand a treatment solution. Design engineers can refer to the EPA [Drinking Water Treatability Database](#) and [Health Advisory Tables](#) (USEPA 2012) for information and many other resources on emerging and unregulated contaminants. Please contact your regional office early in the process if you are considering treatment for an unregulated contaminant.

10.3 Predesign Studies

We **require** predesign studies, including pilot studies as appropriate, for proposed treatment projects (WAC 246-290-250). The goal of the predesign study is to establish the most effective treatment approach, considering life-cycle costs, to produce treated water that meets all regulatory requirements. A predesign study should precede the project report. As such, the information from the predesign study **must** be in the project report (WAC 246-290-250). Predesign study options include desktop, bench, and pilot studies.

Desktop studies involve reviewing detailed water quality data, guidance documents, technical publications, and other information to select a treatment approach for further evaluation or full-scale design. Desktop studies usually require significant amounts of water quality data to guide the selection of an appropriate treatment alternative. Desktop studies can be useful in evaluating distribution system effects (e.g., corrosion) associated with any new or modified treatment process.

Bench-scale studies include jar testing to identify an initial coagulant dose, initial chemical dosages for iron and manganese sequestering, and estimates of disinfection demand and decay.

Pilot studies often follow desktop or bench-scale studies so engineers can identify design parameters and decide how reliable a treatment process will be over the range of source-water quality conditions.

10.3.1 Pilot Studies

Inadequate pilot testing may result in treatment-process performance inefficiencies or outright failure, delayed implementation of effective treatment, and costly retrofitting or

replacement of treatment facilities. For these reasons, the rule **requires** pilot studies for proposed treatment projects (WAC 246-290-250). Treatment approaches that may not require a pilot study include:

- Simple disinfection for small groundwater sources. Large water systems should perform bench-scale tests on proposed disinfection methods to evaluate the potential for generating regulated disinfection byproducts. See Sections 10.2.1 and 10.2.2.
- Simple in-reservoir aeration for pH adjustment, aesthetic reasons or removal of trihalomethanes.
- Fluoridation.
- When a corrosion control desktop study clearly points to a particular corrosion-control treatment approach consistent with source water quality, operator capacity, and distribution system conditions.
- Identical treatment processes applied to nearly identical source waters, such as reverse osmosis on well-circulated seawater.

Pilot studies attempt to replicate as closely as possible the operating conditions and treatment results expected at full scale. Pilot plants are scaled-down versions of a proposed process, and may be skid or trailer mounted. Engineers use pilot plant testing to ensure treatment is effective, determine final design parameters, and estimate construction and operation costs.

It is impractical to transfer pilot results from one proprietary design to another. Equipment for proprietary processes is usually so specialized that pilot testing results are unique to a specific equipment design (e.g., differences in low-pressure membrane filtration).

Sections 10.3.2 through 10.3.4 discuss the recommended pilot study duration, content of a pilot study plan, and final pilot study report. Section 10.3.5 includes a discussion of full-scale pilot testing.

10.3.2 Pilot Study Duration

Pilot studies should be long enough to demonstrate the effectiveness, stability, and reliability of the proposed treatment system. The testing should include the period of most challenging water quality for the piloted treatment technology. If the pilot study is too short or misses important seasonal changes in source water quality, the process may not work as designed or incur higher than expected operational costs. Pilot studies often are shorter for groundwater than surface water treatment because groundwater quality is usually more stable.

The number of samples collected and the duration of the study can vary widely depending on the type of source, amount of historical data, water quality, and the proposed treatment technology (Logsdon et al. 1996; Ford et al. 2001; AWWA/ASCE 2012d). In some cases, engineers can use bench-scale testing to determine the initial operational parameters for pilot testing and possibly decrease the duration of the pilot study. See Table 10-2 for guidance on the duration and objectives of pilot studies for a variety of treatment processes.

10.3.3 Pilot Study Plan (Protocol)

A pilot study plan is necessary to establish an implementation strategy for evaluating a proposed treatment alternative, or alternatives. The pilot-study plan establishes pilot study goals, the monitoring program, operational requirements, equipment needs, layout, duration, and cost. Several of the elements discussed below are appropriate for desktop or bench-scale studies. Engineers should address them in the protocol they submit to DOH for approval.

Pilot Study Goals: Engineers should use the following goals to determine the scope of a pilot study and for pilot study planning and operational decisions:

- Determine the operational feasibility of a selected technology.
- Establish full-scale water-treatment design criteria.
- Develop more refined cost estimates.
- Provide hands-on operator training for water system personnel.
- Determine projected hydraulic impacts on the water system.
- Select an appropriate treatment technology.
- Determine waste disposal requirements and constraints.

Monitoring Program: Pilot study monitoring programs vary significantly depending on the treatment device, finished water requirements, and the specific contaminants in the source water. Engineers can use Table 10-2 to develop monitoring programs for the treatment technologies listed. For additional guidance, contact one of our [regional offices](#).

Most pilot study monitoring programs should include:

- Water quality parameters.
- Monitoring frequency for each parameter.
- Monitoring equipment and calibration standards.
- Personnel or outside laboratories responsible for monitoring activities.

**Table 10-2
Pilot Study Duration and Objectives**

Treatment	Purpose	Minimum Recommended Duration	Objectives	References
Adsorption	DBP precursors, IOCs, VOCs, SOCs	6-12 months ¹	Run length, hydraulic loading rate, empty bed contact time, finished water quality.	Ford et al. 2001; Cummings and Summers 1994; Westerhoff et al. 2003
Ion Exchange	IOCs	2-12 months	Regeneration frequency, leakage, resin stability, potential for chromatographic peaking, pH/corrosion control, finished water quality.	Liang et al. 1999; Clifford and Liu 1993
Oxidation/Filtration	IOCs	1-6 weeks	Oxidant demand and dose, coagulant dose, hydraulic loading rate, filter run length, finished water quality.	Gehling et al. 2003; HDR 2001
Reverse Osmosis	Desalination	2-7 months	Pretreatment required, flux rate and stability, back flush parameters, chemical dose(s), cleaning frequency, finished water quality.	Kumar et al. 2006; USEPA 2005
Various	Surface Water	Up to 12 months ²	See Chapter 11 and Appendix F, H, and I for further details.	

¹ Engineers can decrease the pilot test period to a few weeks if they use rapid small-scale column tests (RSSCTs).

² See Chapter 11, Table 10-3.

Equipment Needs, Layout, and Calculations: The pilot study plan should include a schematic of the process or processes under consideration and the detailed drawings necessary to construct the pilot facilities. The schematic and the pilot facility design are integral to the overall project design and should include unit processes, pipe sizes, pipe connections, flow direction, chemicals and application points, monitoring points, flow-control devices, monitoring equipment or gauges, and various process elements (such as intakes, pumps and blowers).

Operational Requirements: Pilot study plans should identify the operational requirements necessary to ensure water system personnel understand their role and responsibility to provide routine O&M and data collection. We recommend that the design engineer prepare a schedule to clarify routine pilot study activities for water system personnel and others that may be involved with the study.

Pilot Study Costs: Engineers should develop equipment rental, testing, and operation costs as part of the pilot study plan. Engineers can estimate these costs after they develop the goals, duration, and monitoring program for the pilot study.

10.3.4 Pilot Study Report

A pilot study helps to define the design and operational parameters for a treatment process. Therefore, when a pilot study is required, engineers **must** prepare a pilot study report that evaluates pilot-study data and determines whether the treatment option is feasible for full-scale implementation (WAC 246-290-250 and 676(3)).

General pilot-study evaluation criteria include:

- Tabular data for each measured parameter.
- Graphical data showing the relationships between measured parameters.
- Narrative on the relationships between measured parameters.
- Cost projections for full-scale operation (yearly, monthly, and per customer).
- Final design and operational parameters.
- Recommendations for full-scale implementation.
- Comparison of recommended design and operational parameters to design goals, water quality goals, and other performance benchmarks.

For pilot studies longer than 4 months, we recommend that the design engineer submit an interim status report once every two months. These reports will serve as useful checks on pilot study objectives, costs, progress, and findings. It also will help to determine whether the engineer should continue the pilot study as planned, amend the pilot study protocol, or end it and pursue a different treatment approach.

10.3.5 Full Scale Pilot Study

Some water systems are so small that the capacity of a common pilot plant is equal to the capacity of the full-scale treatment unit. In such a case, the water system and designer should approach the pilot facility design as if it will be a permanent facility in the future. As such, the engineer **must** prepare a project report and construction documents (See Sections 10.4 and 10.5).

Final DOH acceptance of the full-scale pilot facility depends on a successful demonstration as determined by an approved pilot-study report (see Section 10.3.4). The water system and engineer take on significant risk when designing a pilot to full-scale because treatment efficiency or operation costs may not match predesign

expectations. They also may need to make major modifications or completely abandon the approach. Submittals for full-scale pilot testing should identify actions the engineer will take if it is necessary to make major modifications or abandon the project.

A water system may deliver water for public consumption produced from a full-scale pilot plant if it meets all of the following conditions. See Section 10.9 for additional information about placing a water treatment plant into service.

1. DOH approves the plans and specifications (construction documents), start-up, testing, and operation procedures as part of a pilot-study plan before the full-scale pilot plant is constructed.
2. Source capacity limitations on an existing water system do not provide adequate source capacity for the combined demand of the existing customers and the pilot study.
3. The design engineer demonstrates to our satisfaction that the treatment process will not increase risk to consumers.
4. Treatment plant facilities are pressure tested, flushed, disinfected, and tested for all applicable drinking water contaminants.
5. A properly certified operator is available to operate the treatment equipment.
6. The treatment system technology is:
 - a. An approved alternative filtration technology (if a surface water application).
 - b. Constructed of components listed under ANSI/NSF Standard 61.

10.4 Project Reports

The water system **must obtain DOH approval** of project reports before installing any new or expanded treatment facilities (WAC 246-290-110). The engineer should submit a final project report for treatment facilities before submitting construction documents. Project reports for treatment facilities should reference all planning, design, and applicable pilot study reports for the proposed facility. They **must** include:

- Detailed design criteria and calculations.
- Process control information.
- Proposed methods and schedules for start-up, testing, and operating the completed treatment facility.
- Operator training and certification requirements.
- Reliability.

See Chapter 2 for guidance on preparing project reports.

10.4.1 Design Criteria and Facility Design

Project reports **must** include design criteria for all major treatment-facility project elements (WAC 246-290-110(4)(h)). Project design criteria and calculations should include the following:

- **Overall process design.** The design engineer should create a detailed narrative of design concepts, design calculations, and supporting information for the treatment process(es), process piping and equipment, process control, and waste disposal.
- **Other project design elements.** The design engineer should outline the general design aspects, such as siting issues, ingress or egress access, roads, sidewalks, parking, earthwork, drainage facilities, building layout and design, special structural requirements or constraints, heating, ventilation, fire suppression features, general utilities, electrical supply, chemical storage and feed system(s), all-hazards assessment, and operator safety.
- **Cost and financing.** The engineer **must** include construction cost estimates, O&M cost estimates, and the proposed financing method(s) if not already covered in a current approved water system plan (WAC 246-290-110(4)(b)(vii)). At this stage, the accuracy of the projected cost depends on how well the construction documents are completed, but should be within 10 percent of the actual cost (AWWA/ASCE 2012g). The engineer should identify the cost-estimation method and compare the final cost estimates to the estimates in the financial program of the water system plan, if applicable.

10.4.2 Process Control—Monitoring, Instrumentation and Alarms

Overall process control is important to ensure that the treatment process can function safely and reliably at all times, especially when unattended. Project reports for water treatment facilities **must** address process control (WAC 246-290-110(4)(h)). The description of process control can range from the simple interconnection of a chemical feed pump with the well pump controls to detailing specific process monitoring and control set points. For more complex treatment facilities, the description and analysis of overall process control should include monitoring, instrumentation and alarms.

Monitoring

Water systems should monitor all treatment processes. Monitoring ensures that the treatment plant meets applicable treatment technique or maximum contaminant levels. This monitoring can include water quality measurements, like chlorine residual and pH, and physical parameters such as flow, pressure, and tank level. The means, methods, and frequency for monitoring water quality and physical parameters **must** be clearly identified for each treatment process in the project report (WAC 246-290-110(4)(h)). For

treatment processes that remove regulated primary chemical contaminants, a certified lab **must** analyze the treated water at least monthly (WAC 246-290-455). Additional monitoring may be required based on the complexity or size of the treatment process.

Engineers should develop draft monitoring procedures and forms early in the design process to support monitoring of the treatment process when it is completed. Some treatment process monitoring forms are on the [Drinking Water Forms website](#). If you can't find a standard form on the website, please contact your regional engineer to identify the monitoring and reporting requirements needed to help ensure that the system operates the treatment process as designed.

Engineers **must** provide sample taps before treatment to assess the source water quality, and after treatment but before entering the distribution system (WAC 246-290-300; WAC 246-290-320(2)(g); WAC 246-290-451). Engineers should provide additional sample taps at intermittent points in more complex treatment plants to help in process control, verify on-line analyzers, and assess specific treatment processes.

Engineers should locate source sample taps upstream far enough to avoid influence from downstream chemical injection. Engineers should locate sample taps for treated and partially treated water after added chemicals mix completely. Because turbulent flow conditions can dislodge pipe scale or entrain air, avoid sample taps in turbulent flow locations, such as near valves, ells, tees and flanges. Also, avoid tapping the bottom or top of the pipe, which can introduce sediment or air. We recommend using a sample probe or quill to sample from the center of the pipe.

Sample taps should be smooth nosed without any internal or external threads to reduce the risk of microbial contamination or aeration of the sample. Aeration can change the pH or result in loss of chlorine residual so that the sample is not representative of the water in the pipe.

Instrumentation

On-line instrumentation is often required to ensure that a treatment process is working well. Instrumentation can minimize the risk of customer complaints as well as improve public health protection. The design engineer should identify the benchtop equipment needed or other ways the operator can verify the readings from the on-line instrumentation in the project report. This benchtop equipment will allow the operator to check on-line instrumentation periodically as components age or become fouled with time.

Engineers should address several design considerations when locating and installing on-line instrumentation:

- **Operator safety and ease of access:** Instrumentation should be in safe, non-corrosive environments where operators have easy access and ample clearance to service the device.
- **Calibration, verification, and testing:** All instrumentation requires periodic calibration. It also often requires frequent verification as the manufacturer or approved methods specify. Engineers also should consider the means for physically testing alarms associated with instrumentation, such as the ability to spike the sample upstream of the instrumentation (WSDOH 2013).
- **Sample piping:** Engineers should keep sample lines as short as possible and use small diameter non-translucent piping or tubing. In general, the sample delay should be less than 2 minutes between the pipe and instrumentation.
- **Flow and pressure control:** There should be a way to measure and control the pressure and flow to the instrument. Such control is necessary to ensure that the flow rate is within manufacturer specifications and pressure fluctuations do not affect the instrumentation.
- **Power supply:** Engineers should protect instruments with surge protectors and uninterruptible power supplies. Do not locate instruments near equipment with large electrical motors. Some instruments, such as pH analyzers, are especially sensitive to small changes in the power supply.

For additional guidance related to the proper installation of instrumentation see *Monitoring Surface Water Treatment Processes* ([DOH 331-620](#)) (WSDOH 2018b).

Alarms

Engineers should identify alarm conditions, especially for critical process components where very high or very low levels could lead to unsafe water delivered to customers. Critical alarm conditions for water treatment facilities can include water quality and physical parameters such as:

- **Flow rate:** The system should not exceed the maximum flow rate through a treatment process. Doing so may cause the process to fail or lead to a treatment technique violation.
- **Water level:** A clearwell or reservoir needs a minimum level of water to ensure adequate disinfection. There also may be a critical level of stored water needed to backwash filtration equipment.
- **Pressure:** Filtration often requires operators to closely monitor the differential pressure across the treatment process (head loss) to ensure that the equipment does not exceed regulatory or manufacturer acceptable thresholds.

- **Turbidity:** While primarily used to monitor the effectiveness of surface water treatment processes, operators can use turbidity to monitor groundwater filtration processes and minimize the risk of failure and customer complaints.
- **Disinfectant residual:** Water systems commonly use chlorine residual analyzers to address microbial health concerns. Systems also could use these analyzers in other applications to minimize the risk of process failures.
- **Inorganic chemicals:** We recommend that water systems install continuous monitoring for a chemical contaminant if a treatment process failure could lead to an acute health risk. For example, between 2014 and 2016, there were 32 nitrate treatment-plant failures reported in Washington. Nitrate is an acute contaminant. Each treatment plant failure resulted in a nitrate MCL violation and a bottled water advisory. While operators did do daily nitrate monitoring, continuous monitoring would have provided more timely notification and lowered public exposure to an acute drinking water contaminant.
- **pH:** A significant rise or drop pH, can make treatment ineffective, cause water quality effects in the distribution systems, lead to treatment technique violations, and, in extreme cases, place public health at risk.
- **Conductivity:** Water systems most often use conductivity to monitor high-pressure membranes, such as reverse osmosis and nanofiltration units, and to confirm that the membranes are intact.

You can find additional information on the design of alarms for water treatment plants in [Testing Critical Alarms](#) (DOH 331-472) and the “Policy Statement on Automated/Unattended Operation of Surface Water Treatment Plants” in the *Recommended Standards for Water Works* (Ten State Standards, 2012). Although the authors intended these references primarily for surface-water treatment plants, the information applies to other situations, such as water systems with installed corrosion control, pH adjustment, or continuous source disinfection.

Alarm conditions normally trigger audible or visual notification to the operator and other personnel. If a water treatment facility will often be unattended, the engineer should consider an alarm that will automatically dial the relevant water system staff and shutdown the treatment plant—especially if a treatment process failure could result in an acute health risk. After an alarm automatically shuts down a treatment plant, it should not be able to restart until an operator is physically present at the treatment plant. Some treatment plants that restarted automatically led to process failures putting the health of consumers at risk.

10.4.3 Operations, Start-up, and Testing

The ongoing maintenance and operation of a water treatment facility is essential to ensuring the long-term success of a project and protecting public health. Even the smallest and simplest treatment facility should have a back-up operator identified, so that public health does not suffer if the primary operator becomes ill, needs to attend to family matters, takes leave, or participates in required training and professional development opportunities.

Operations

Project reports for treatment facilities **must** address operation of the completed project (WAC 246-290-110(4)(h)). The design engineer and public water system should work together with an experienced certified water-treatment plant operator to develop a staffing plan and include it in the project report they submit to DOH for review and approval. The staffing plan should:

- Establish the water system's legal obligation to remain fully staffed even on holidays and weekends, and to maintain the treatment plant facilities. It also should describe the corrective actions it will face if it fails to do either.
- Identify the organization or people responsible for operating the proposed facility, their required qualifications, and their responsibilities in the plant.
- Prepare a draft [Purification Plant Criteria Worksheet](#) and identify the correct treatment plant classification. The worksheet is on our [Operator Certification webpage](#).
- Describe the training program for new operators.
- Describe the succession planning process for replacing operators who leave or retire.
- Describe back-up staffing if one or more existing operators are unable to perform tasks.
- Evaluate the number of staff required for safe and reliable operations, considering such factors as:
 - **Treatment Technology:** Complex treatment technologies and those with multiple treatment objectives require more operator oversight than simple treatment systems. Treatment for primary contaminants may have a higher consequence of failure and need more attention.
 - **Location:** It may be difficult for small plants to attract and retain highly certified operators, especially plants in remote locations. For those plants, simpler technologies less prone to failure are more appropriate than complex treatment processes requiring a higher level of operator certification. In-plant

- training programs are essential in these areas to ensure new operators are trained, qualified, and readily available.
- **Automation:** A well-trained operator is essential to ensure public health protection. Automation can help to improve process control and ensure smooth operations when treatment plants are unattended, but cannot replace a well-trained professional to oversee operations and take action if an equipment or process failure occurs.
 - **Water Quality:** A source with multiple water quality issues may require more time for staff to make treatment adjustments to meet water quality goals. The project report should identify seasonal or other variations that could affect staffing needs.
 - **Treatment Capacity:** Larger treatment facilities have more equipment and instrumentation than smaller treatment facilities. Thus, they require more staff time just to keep the facility in good working condition, and the consequences of failure are more significant.
 - **Plant or System Layout:** A compact plant or system with centrally located controls requires a smaller staff than a facility spread over a larger area.

Section 11.4.4 has additional staffing considerations for surface-water treatment facilities, and Chapter 11 covers operations and monitoring requirements at these facilities.

Start-up and Testing

The start-up and testing of a treatment plant is a complex operation. Project reports **must** include proposed methods and schedules for start-up and testing (WAC 246-290-110(4)(h)). Engineers may revise these methods and schedules as needed prior to completing construction. Schedules should include the anticipated start-up date and proposed testing duration. Methods should identify specific standards and the persons involved. Engineers may cite general methods and schedules in the project report and refine them in the construction documents.

Final plans should identify the persons involved and their specific roles in the start-up and testing. The plans also should identify the specific criteria the engineer will use to determine whether it is safe to serve the treated water to consumers, test the treatment equipment, prove reliable operations, and affirm water quality standards. The criteria is project specific. It could range from simple grab samples for chemical addition processes to detailed evaluation criteria for multiple processes in complex treatment facilities.

Prior to start-up, meetings involving the design engineers, contractors, and others should occur. They will help to ensure a smooth and successful start-up for the new treatment plant. See Section 10.9 (Putting a Water Treatment Plant into Service) for additional information on start-up requirements and recommendations. If the project receives funding from our Drinking Water State Revolving Loan Fund, you should include provisions for these meetings in the project specifications and contract documents.

For large or complex water-treatment plants, engineers should submit a start-up and testing plan separate from the project report and construction documents.

See Section 10.9 for additional information the engineer **must** address before putting any new or modified water treatment facility into service.

10.4.4 Treatment System Reliability

Treatment reliability means the failure of a single component will not result in delivery of unsatisfactory drinking water to consumers. Engineers **must** design water treatment facilities to meet minimum water quality standards at all times (WAC 246-290-200(2) and 420(1)). Guidance on treatment-process reliability is in published design references (AWWA/ASCE 2012e; Ten State Standards 2012).

Reliability is especially important to public health when a treatment process failure presents an acute health risk. Examples include groundwater requiring 4-log virus inactivation, nitrate removal, and surface water treatment. Drinking water standards and rule codify the appropriate application of continuous on-line analyzers and alarms. For example:

- **4-log virus inactivation of groundwater:** Water systems serving more than 3,300 people and required to provide 4-log virus inactivation of groundwater **must** have continuous chlorine residual monitoring and alarms installed (WAC 246-290-453 and -485).
- **Nitrate:** Treatment plants for nitrate removal should have an on-line finished water nitrate analyzer (Section 2.9 of Ten State Standards 2012). Design engineers that do not propose to install an on-line analyzer should provide an equivalent level of process monitoring and assurance of public health protection if a treatment process failure occurs.
- **Surface water treatment:** Surface water treatment plants **must** have monitoring and alarm devices that measure and warn of critical treatment process failures (WAC 246-290-678). See Chapter 11 for details on reliability for surface water treatment plants.

10.5 Construction Documents

Before installing new or expanded treatment facilities, water systems **must** obtain DOH approval of the final construction documents (WAC 246-290-120). The construction document submittal **must** include detailed drawings and specifications. Some small projects may include relevant specifications on the construction drawings, if applicable. Chapter 3 summarizes the information that must be in all construction document submittals. Design engineers should review the checklists in Appendix A to confirm they meet the minimum submittal requirements.

10.6 Treatment Chemicals

All treatment chemicals **must** be used within the maximum application dosages listed in NSF/ANSI Standard 60 (WAC 246-290-220(3)). In water treatment facilities, the improper storage and application of treatment chemicals may present a potential hazard, similar to that at an industrial or chemical plant. Treatment plants and some distribution treatment facilities store large quantities of chemicals, such as chlorine gas, hypochlorite compounds, aluminum sulfate, caustic soda, fluoride compounds, potassium permanganate, ammonia, and numerous proprietary organic polymers. Typical treatment practices feed these products directly into treated potable water or water being processed into potable water.

Chemical addition, when uncontrolled, can result in a dangerous overfeed due to improper design, operation, or maintenance of feed equipment. Specific risks include component failure, backflow, and backsiphonage. Design manuals provide information and recommendations for preventing these types of failures (*Recommended Standards for Water Works* (Ten State Standards 2012) or *Water Fluoridation Principles and Practices* (AWWA 2016)). Important considerations when designing of the chemical feed system include:

- Chemical overfeed prevention.
- Safe storage and handling.
- Cross-connection control.

10.6.1 Chemical Overfeed Prevention and Feed Systems

Injecting chemicals into the water supply always poses some potential of overfeed if equipment is not designed, installed, operated, or maintained properly. Overfeeds of ammonia, chlorine, sodium hydroxide, and fluoride have been reported (Brender et al. 1998; AWWA 1993; AWWA 2016; Lee et al. 2002).

Operation and maintenance errors, design flaws, mechanical failure, installation errors, or a combination of factors can cause these failures. Documented failures include:

- **Ammonia Overfeed.** A water system moved an ammonia injection point downstream in the process to increase free chlorine contact time prior to chloramine formation; and, the hydraulic head on the bulk storage tank was sufficient to allow ammonia to flow into the main without pumping. The antisiphon valve designed to prevent overfeed failed, allowing the full bulk storage tank to empty into the water system. Operators failed to recognize the problem despite unusually high pH values and unusually low chlorine residuals.
- **Sodium Hydroxide (Caustic Soda) Overfeed.** To control corrosion, the water system treated a well supply with sodium hydroxide. When operators closed the distribution system valves to complete a main repair, the pressure at the well increased significantly, reducing well production from 450 gpm to less than 85 gpm. The caustic feed system was not flow paced. As a result, the pH of the water eventually reached 13. Two people who drank water from a nearby public fountain received mouth and throat burns. The pressure and pH build-up occurred over a two-day period; daily inspection of the well and treatment system would have caught the problem sooner.
- **Fluoride Overfeed.** In 1992, an incident in Hooper Bay, Alaska, caused 1 death and about 262 illnesses. An incorrectly wired circuit for the fluoride feed pump (in parallel instead of in series) allowed fluoride solution to pump into the water system even though the source wasn't operating. This "slug" of fluoride (up to 150 mg/L) was delivered to customers.
- **Chlorine Overfeed.** A computer controller card on a rate-of-flow controller malfunctioned, failing to shut down the chlorination circuit when the well sources (controlled by reservoir levels) shut off. Nearby customers noticed the continued injection of chlorinated water when the well sources were called on again, and the water was delivered to the distribution system.

Design elements and appropriate standard operating procedures (SOPs) can minimize the potential for overfeed. Below are some design items engineers should consider to minimize the risk of overfeeds. See Appendix F.2 for design elements to reduce the potential for fluoride overfeed.

1. Include day tanks when the system needs to use large bulk volumes of treatment chemicals. Size the day tanks to store no more than 30 hours of supply and have an operator fill the tanks in a controlled manner (Ten State Standards, 2012). These tanks promote daily inspection of the feed systems, and reduce the magnitude of an overfeed.

2. Evaluate the failure modes of the equipment, and add redundant safeguards if needed. In the chlorine and fluoride overfeed examples cited above, a redundant flow switch wired in series with the feed pumps would have stopped the chemical injection system after it detected a lack of treated water flow. Alternately, engineers should consider the feasibility of installing flow-based chemical feed control.
3. Select chemical injection points to minimize the potential for siphoning or hydraulically draining chemical storage tanks, even if their design includes antisiphon features.
4. Include continuous monitoring equipment with integrated alarms (pH, chlorine, fluoride). In some cases, you should provide redundant monitoring equipment. It is appropriate for these alarms to shut down the equipment automatically (see Section 10.4.2).
5. Consider the capacity of the operator(s) to operate, control, and maintain the water-treatment plant facilities properly. Operator error, or operator inattention, caused or aggravated several of the overfeed incidents described above. SOPs should tell operators how to react to unexpected changes in water quality parameters (increasing or decreasing pH, values outside "normal" ranges, and other issues).
6. Focus SOPs on routine equipment maintenance. For example, water systems should inspect their antisiphon valves periodically and replace them as needed.
7. Provide appropriate cross-connection control (see Section 10.7).

10.6.2 Safe Chemical Storage and Handling

Engineers should carefully consider chemical delivery and storage when designing water treatment plants. Improper delivery, storage, or use may result in a toxic or explosive environment. For example, sodium hypochlorite mixed with ferric chloride or aluminum sulfate (alum) releases chlorine gas. Calcium hypochlorite mixed with acids or brought into contact with combustible materials (oil, grease, kerosene, gasoline, paint products) may cause a fire or explosion.

The design engineer should discuss the safe use and storage of treatment chemicals with the local fire marshal, building code officials, and other authorities responsible for implementing regulations as part of the design process. General design considerations should include:

- Make eyewash and shower stations with tempered water accessible to operators and delivery personnel.
- Provide containment around chemical storage and feed facilities.

- Use seismic bracing, supports, and pipe design to prevent damage to chemical storage and handling facilities in an earthquake.
- Separate delivery, storage, and feed facilities for strong oxidants, such as gaseous chlorine or calcium hypochlorite.
- Clearly label chemical fill ports, piping, and storage tanks with the chemical used.
- Put locks on every chemical fill port to prevent access when the operator isn't present.
- Install covered spill containment around chemical fill ports.
- Provide equipment to contain and scrub chlorine gas.
- Meet egress and ingress requirements for rooms or areas with chemical storage and feed facilities.
- Comply with all applicable OSHA and WISHA standards, such as signage, safety gear, training, atmospheric monitoring devices, ventilation, and eyewash and safety shower location.
- Put EPA requirements in the [Risk Management Program](#) if the system stores large volumes of chemicals, such as 2,500 pounds or more of chlorine gas.

Water systems often use hypochlorite for disinfection and other water treatment purposes, so you may find the following information useful.

Sodium Hypochlorite. Concentrated sodium hypochlorite solution (5.25% to 12.5%) is a corrosive liquid with a pH of greater than 11. Therefore, the operator should use precautions typical for handling corrosive materials, such as avoiding contact with metals, including stainless steel. The design should provide spill containment for the sodium hypochlorite storage tanks. Typical spill containment structures have separate containment areas for each incompatible chemical and no uncontrolled floor drains. They are large enough to contain the entire contents of the largest tank plus rain or water from fire sprinklers. Bulk sodium hypochlorite should be stored at a concentration of no more than 3 percent chlorine by weight.

Calcium Hypochlorite. Calcium hypochlorite is an oxidant. As such, systems should store it separately from organic materials that could readily oxidize. It also should be stored away from sources of heat. Improperly stored calcium hypochlorite has caused spontaneous combustion fires.

Other: Chemicals commonly used in water treatment plants that may require special design and handling considerations include:

- Primary coagulants, such as alum and ferric chloride.

- Strong oxidants, such as hydrogen peroxide, potassium permanganate, and ozone.
- Strong bases, such as sodium hydroxide,
- Strong acids, such as citric, fluorosilicic, and phosphoric acids,

You can get extensive information on the safe storage, handling, material compatibility, and use of common water treatment chemicals in sources, such as:

- *Recommended Standards for Water Works - Part 5* (Ten State Standards, 2012)
- *Integrated Design and Operation of Water Treatment Facilities* (Kawamura, 2000a)
- *Water Treatment Plant Design - Chapter 20 Chemical Systems* (AWWA/ASCE 2012e)

10.7 Cross-Connection Control for Water Treatment Facilities

Protecting drinking water from contamination starts at the source and continues through treatment facilities designed to improve water quality. In water treatment facilities, this protection requires engineers to incorporate safeguards into their designs.

In water treatment facilities, the improper storage and application of chemicals presents a potential cross-connection hazard similar to that found in an industrial or chemical plant. Treatment plants and some distribution treatment facilities store large quantities of hazardous materials, such as chlorine, hypochlorite compounds, aluminum sulfate, caustic soda, potassium permanganate, and numerous proprietary organic polymers. In typical treatment practice, these products feed directly into treated potable water or into water being processed into potable water. Most treatment works also contain significant quantities of raw, or incompletely treated water.

Potable water in a treatment facility is often at atmospheric pressure. This increases the potential for cross contamination, particularly due to backflow or backsiphonage, which could involve treatment chemicals, and raw or partially treated water.

10.7.1 Premises Isolation

Premises isolation involves protecting the water supply by installing backflow prevention assemblies, usually at or near the point where water enters a building or facility. Because the chemical hazards in a waterworks facility can be identical to those in industrial facilities, engineers **must** equip the potable water service line(s) to a water treatment plant with an air gap or reduced pressure backflow assembly (RPBA) (WAC 246-290-490).

Because premises isolation does not protect against backflow within the plant, the treatment facility should provide separate “potable” and “process” supply systems within the building(s). Many water treatment facilities require a separate potable water supply system to supply lavatory or kitchen sinks, eyewash and shower facilities, drinking fountains, and other human consumptive uses. Process water uses in a water treatment plant may include diluting treatment chemicals, carrying concentrated feed solutions, driving eductors, mixing, and supplying surface washers.

10.7.2 Cross-Connection Control inside the Water Treatment Plant

To protect the quality and safety of the plant’s potable water supply, engineers **must** equip each potable water connection to the plant process-water supply system with an approved air gap, a reduce pressure backflow assembly, or both (WAC 246-290-490). Design engineers should limit potable water to supply unit treatment processes from no more than two discrete points. See Table 4-4 of *Cross Connection Control: Accepted Procedures and Practice Manual* (PNWS-AWWA, 1996). In addition, wherever the plant process water supply system supplies multiple processes, engineers should protect each process (“fixture”) against backflow to protect the integrity of the process water system.

For example, the engineer should equip the process water supply to an upflow fluoride saturator (see Appendix F.2) with a reduced pressure backflow assembly or approved air gap to prevent fluoride backflow into the process supply to the gas chlorine eductor. This approach is called “fixture” protection. In water-treatment plant design, cross-connection control should incorporate premise isolation and fixture protection principles. Table 10-3 lists backflow prevention assemblies for water treatment plant equipment and processes.

To identify piping more easily, we recommend that design engineers use a piping color code to identify potable and process water lines. See description in Ten State Standards 2012.

Some common backflow situations and their associated requirements:

- 1. Discharge to waste:** There must be an approved air gap between all process water and waste path, and all finished water and waste path.
- 2. Gaseous chlorinators and ammonia feed:** There must be a reduced pressure backflow assembly (RPBA) between the potable water supply and the gas chlorine or gas ammonia-water mixing point (“eductor”). There must be no branching of solution lines downstream of a gas eductor to water at different

stages of treatment (e.g., raw water, prefilter, and post-filter). These branch lines are potential cross connections between inferior and superior quality water.

- 3. Sample lines to process monitoring instruments:** There must be no branching of sample lines to water at different stages of treatment (e.g., raw water, prefilter, and post-filter). These branch lines are potential cross connections between inferior and superior quality water.
- 4. Upflow saturators (for all chemical compounds, including sodium fluoride):** There must be an RPBA between the potable water supply and the upflow saturation tank.
- 5. Down-flow saturators and other hard-plumbed piping to chemical feed solution tanks:** There must be an air gap or RPBA between the potable water supply and the chemical solution tank.
- 6. Erosion feed systems:** When used in combination with a secondary tank, there must be an RPBA or air gap to protect the potable water supply from any holding tank. Evaluate erosion feeders on a case-by-case basis to ensure you install adequate backflow prevention.
- 7. Solution tanks without approved air gaps (i.e., filled by a hose):** There must be an RPBA between the drinking water supply and the hose bib(s) used to fill the solution tank(s). All hose bibs should have a hose bib vacuum breaker.
- 8. Membrane filtration clean-in-place systems.** Water systems need to mitigate cross-connection control risks to prevent chemicals used in the membrane cleaning process from contaminating the feed or filtrate streams during both the clean-in-place (CIP) process and under normal operation. This situation presents a unique challenge because pipe-flow directions change during membrane plant cleaning, precluding the use of normal cross-connection control devices. Water systems need two key design elements working in unison to minimize the risk that chemicals used in the membrane cleaning process enter the treated water:
 - a. At least two valves working together to isolate the cleaning chemicals, so that failure of a single valve does not place consumers at risk.
 - b. An observable vent to atmosphere, so an operator can see the leakage when a valve fails.

The most common approach used to achieve this risk isolation is to place double-block and bleed valves in three locations: 1) on the feed line to each bank or skid; 2) on the filtrate line leaving each bank or skid; and 3) on the CIP feed line. See EPA's *Membrane Filtration Guidance Manual* for further details (USEPA 2005).

Engineers usually equip treatment heads on ion exchange reactors that rely on brine regeneration with a common line for filling and withdrawing water. These installations create, use, and regenerate the brine solution and do not require backflow protection. The treatment head design precludes the possibility of backflow conditions during normal operation.

10.7.3 Other Design Considerations

There should be backsiphonage control at the point of chemical injection into the public drinking water supply to protect against overfeed . We recommend applying the following standards.

1. **All liquid chemical feed systems:** Install one diaphragm-type antisiphon device at the head of the metering pump (spring-loaded diaphragm in the closed position). If feeding fluoride, hydroxide, or an acid, install a second antisiphon device at the injection point.
2. **Potable water as transport carrier solution (e.g., gas chlorine, ammonia):** Install one diaphragm-type antisiphon device at the injection point into the potable water carrier pipe (diaphragm spring-loaded in the closed position).

Other ways the design can minimize the risk of chemical overfeed are in Part 5 of the *Recommended Standards for Water Works* (Ten State Standards, 2012).

10.7.4 Common Wall Construction in Treatment Facilities

Engineers must avoid the cross-connection contamination risk associated with failure of a common wall between untreated or partially treated (nonpotable) and finished water (filtered). Common walls may be structural or piping.

- **Structural walls:** Although this is a greater concern for package-filtration treatment plants, it could apply to any treatment process designed with adjacent walls between various unit processes. In surface water treatment applications, engineers should design double-wall separation (an air space) between unfiltered water (flocculation and sedimentation basins) and filtered water (underdrains and clearwell). This will allow operators to check for fractures in either wall (the air space will fill with water). See Chapter 11 for further details.
- **Piping through filter media:** There must be no air supply or other piping installed vertically through filter media. The pipe represents a direct conduit between unfiltered and filtered water.

**Table 10-3
Recommended Protection at Fixtures and Equipment
In Water Treatment Plants ***

AG	Air Gap	PVBA	Pressure Vacuum Breaker Assembly
AVB	Atmospheric Vacuum Breaker	RPBA	Reduced Pressure Backflow Assembly
DCVA	Double Check Valve Assembly		

Description of Fixture, Equipment, or Use	Minimum Protection at Fixture
Untreated and process water tanks	Provide AG on overflow and drain
Bulk liquid chemical storage tanks	<ol style="list-style-type: none"> 1. Provide AG on dilution water supply line, and 2. AG on overflow and drain, and 3. Provide day tank.
Day tanks	<ol style="list-style-type: none"> 1. Provide AG on dilution water supply line, and 2. AG on overflow and drain, and 3. Size to hold no more than a 30-hour supply
Dry chemical feeder solution tanks	<ol style="list-style-type: none"> 1. Provide AG on fill supply line, and 2. AG on overflow and drain
Saturators	<ol style="list-style-type: none"> 1. Provide AG or RPBA on fill supply line, and 2. AG on overflow and drain
Chemical feed pumps, general	<ol style="list-style-type: none"> 1. Ensure discharge at point of positive pressure, or 2. Provide vacuum relief (antisiphon device), or 3. Provide other suitable means or combinations as needed to control siphoning 4. No pump priming or flushing line
Chemical feed pumps, fluoride compounds	<p>In addition to general recommendations for chemical feed pumps, these precautions apply:</p> <ol style="list-style-type: none"> 1. Provide dedicated electrical connection interlocked with well or service pump, and 2. Provide two diaphragm-type antisiphon devices (one at pump head, one at injection point), and 3. Size pumps to operate at 30 percent to 70 percent of capacity.
Chemical carrying line, chemical injection line, eductor line	Provide RPBA
Chemical injection line in common between potable water and nonpotable water	Provide RPBA or manifold chlorine gas rather than chlorine solution, eliminating cross connection (use separate injectors for untreated and filtered water, if applicable)
Surface washers	Provide AVB or PVBA or DCVA
Filter backwash waste discharge	Provide AG to waste
Filter-to-waste	Provide AG to waste, or AG to process stream ahead of filters
Membrane clean-in-place systems	Provide block and bleed valves on the clean-in-place supply, feed, and filtrate lines for each membrane skid.
Sample lines to monitoring equipment	Provide AG or AVB

Monitoring equipment for untreated and potable water that is used in common	Provide AG or physical disconnect
Hose bibb connections	Provide hose bibb vacuum breaker (at hose outlet)

*These recommendations assume isolation of process water supply from the potable water supply. Air gaps to treated or partially treated water must be screened

10.8 Water Treatment Plant Wastewater Disposal

Design engineers should evaluate waste-product issues early because they could significantly affect the cost or feasibility of a proposed treatment approach or technology. Water treatment processes can generate a variety of liquid-waste streams:

- Backwash waste from filtration processes.
- Brine waste from ion exchange treatment.
- Concentrate high in dissolved solids from reverse osmosis and nanofiltration processes.
- Filter-to-waste streams from filtration processes.
- Waste chemicals from membrane cleaning processes (clean-in-place waste).
- Discharge from on-line instrumentation, such as chlorine residual analyzers, pH analyzers, and turbidimeters.
- Other concentrate streams from clarification and sedimentation processes, usually only found in plants that treat surface water.

There is detailed guidance on treating, processing, and otherwise managing these liquid waste streams in a number of professional references (AWWA/ASCE 2012c; Kawamura 2000a; AWWA 1999; Ten State Standards 2012).

Some design engineers may consider recycling water from the backwash process. However, the recycled water may contain higher levels of turbidity, pathogens, or treatment chemicals than the source water. Therefore, to recycle water from backwash, engineers should consider:

- **Backwash holding tank sanitary integrity:** If designing a system to use backwash recycling for groundwater sources, the engineer should design the backwash holding-tank similar to a treated water reservoir. This will minimize the risk of any pathogen entering the recycle stream.
- **Determining required settling time:** Settling time is a key design parameter when sizing a backwash holding-tank. Engineers can use settling columns to estimate the time required to separate the supernatant from the solids.

- **Reintroducing the backwash supernatant:** Recycle the supernatant back into the treatment process at a point prior to the addition of any chemical. Limit the supernatant recycle flow-rate to no more than 10 percent of the plant influent flow-rate to minimize the risk of process upset. Recycled supernatant in surface water treatment plants **must** enter the main flow stream at a point prior to addition of the primary coagulant (WAC 246-290-660(4)). Check to be sure recycling does not hydraulically overload any part of the treatment process.
- **Monitoring the supernatant backwash:** In addition to monitoring and controlling the flow rate on the supernatant, the system should continuously monitor the turbidity of the supernatant stream. Turbidity is not a regulated parameter for groundwater sources, but it is a useful parameter for surface water and groundwater treatment plants to use when measuring the quantity of solids in the supernatant and minimizing the risk of overloading the filters with recycled solids.
- **Discarding solids from the backwash recycle process: Sometimes the settled material concentrates.** It is more challenging to discard the waste into a sanitary sewer when the concentrate is naturally occurring metals, such as arsenic, iron, and manganese. Engineers should consider other means of disposal, such as drying solids for disposal at the landfill or using geotextile tubes to capture the solids.
- **Emergency disposal of backwash water:** The engineer's design should include a way to dispose of backwash water if a treatment process upset overwhelms the recycle process. Emergency disposal could include disposal to land, a drainage ditch or a sanitary sewer so that the treatment process can function properly and public health is protected.

The Department of Ecology manages the permitting process for wastewater discharges from water treatment plants (WTPs). Ecology considers WTPs that discharge wastewater as industrial dischargers, whether they discharge their wastewater to the land, surface water, or local public treatment works.

Ecology may issue a general or individual permit.

General Permits: Ecology permits wastewater discharged from a water-treatment filtration process under its combined National Pollutant Discharge Elimination System (NPDES) and State Waste Discharge General Permit. All eligible facilities **must** apply for coverage. See Table 10-4.

A general permit covers all wastewater discharge from a WTP if it meets **all** of the following criteria:

- The WTP is not covered by an NPDES waste discharge individual permit.
- The primary function of the WTP is to produce water for potable or industrial use.
- The WTP produces an average of 35,000 gallons per day or more of finished water, as determined on an average monthly basis.
- The WTP discharges its wastewater directly to surface water. It also can discharge to a settling pond or basin if the overflow from them can flow to surface water. Surface water includes lakes, rivers, ponds, streams, inland waters, wetlands, marine waters, estuaries, and all other fresh or brackish waters and watercourses, plus drainages to those waterbodies.
- A water-treatment filtration process produced the discharged wastewater (filter backwash, sedimentation or presedimentation basin wash down, sedimentation or clarification, or filter-to-waste).
- The discharged wastewater is not produced from ion exchange, reverse osmosis, or slow sand filtration.

If a WTP that produces an average of 35,000 gallons per day or more of finished water meets all of the following conditions, Ecology considers it "conditionally exempt" from operating under the general permit requirements for filter backwash wastewater discharges.*

- The WTP discharges its filter backwash wastewater to the ground so that most of the liquid either evaporates or infiltrates to the subsurface. However, the area receiving the discharge must not contain highly permeable soils, must not lie directly above a shallow aquifer, must not lie above an aquifer with limited recharge, or lie in a location where groundwater quality appears to be threatened.
- WTP should discharge to a drain field, infiltration pond, or trench only when discharge to land application (irrigation) or a grass-lined swale is not possible. The state Underground Injection Control Act prohibits discharge to a "dry well."
- Infiltration ponds and trenches must have sufficient freeboard to prevent over-topping and water systems must manage them to prevent any reasonable potential for discharge to surface water.
- The wastewater must be free of additives and any amount of toxic material greater than "*de minimis*" that could reach the waters of the state.
- The volume of the discharge and the concentration of dissolved solids do not demonstrate a reasonable potential to contaminate groundwater.
- Discharge must not cause soil erosion or deterioration of land features.

- Residual solids that accumulate in infiltration ponds and trenches must be disposed of as necessary to avoid a build-up and concentration of these materials.
- Disposal of solids must be consistent with requirements of the local health jurisdiction.

* This exemption is subject to Ecology's periodic review of WTP processes and discharge characteristics. Part of Ecology's review includes determining whether a "reasonable potential to pollute" exists, based on defined EPA methods. See Table 10-4.

WTPs that produce an actual average of less than 35,000 gpd of finished water do not require a permit to discharge filter backwash wastewater (filter backwash, sedimentation or presedimentation basin wash down, sedimentation or clarification, or filter-to-waste). Ecology determined that generally, such WTPs have no reasonable potential to pollute. See Table 10-5.

Ecology excludes wastewater discharges from WTPs that employ ion exchange, reverse osmosis, or slow sand filtration from coverage under its General Permit. Depending on site-specific circumstances, Ecology may require such WTPs to obtain coverage under an individual permit. Design engineers employing ion exchange or reverse osmosis should evaluate waste generation issues early and consult with Ecology because waste discharge permit requirements could significantly affect the cost or feasibility of the proposed treatment. See Table 10-6.

Ecology's [webpage](#) on general permits for water treatment plants provides a link to the [current general permit](#), and a link to the [general permit fact sheet](#). The fact sheet explains how Ecology developed the general permit conditions, presents the legal basis for permit conditions, and provides background information on water treatment facilities.

Disposing Analyzer Reagent Waste

Due to the small volumes and low toxicity, Ecology typically does not require a discharge permit for disposing analyzer reagent waste streams to ground. However, Ecology does require facilities to implement appropriate best management practices and all known, available, and reasonable methods of prevention, control, and treatment. Ecology's position is:

- Water systems must not discharge this wastewater to surface water.
- Water systems should discharge this wastewater to the sanitary sewer if at all possible.

- If discharge to the sanitary sewer is not possible, water systems should discharge the wastewater to the ground in a way to maximize evaporation of the reagent. The water system must own the discharge site and it should be as far away as possible from any drinking water supply. Runoff from the discharge site may not flow off the water system property.

10.9 Placing a Water Treatment Plant into Service

Before a water system can place a water treatment plant into service, it **must** properly test, inspect, and disinfect it (WAC 246-290-120(4)). A licensed engineer **must** complete a *Construction Completion Report Form* ([DOH 331-121](#)) and submit it to DOH before a water system uses treatment facilities to serve water to the public (WAC 246-290-120(5)).

It is often useful to have one or more meeting(s) with all parties involved in the design, construction and operation of a treatment facility in the weeks or months before start-up. These parties include representatives of the:

- Construction manager
- Design engineer
- Prime contractor
- Operators
- Owner
- Regulatory staff. Usually the DOH regional engineer.

Such a meeting can help facilitate a smooth start-up and help to address issues that arise during the start-up process.

Water treatment plants often consist of a collection of pipes, pumps, reservoirs and valves. As such, the following sections in this manual should be reviewed for relevant information about placing water treatment plant components into service:

- Section 6.6 Placing a Water Main Into Service
- Section 7.7 Placing a Reservoir into Service
- Section 8.5 Placing a Booster Pump Station into Service

There can be water quality issues associated with the start-up of any treatment facility that could compromise the safety of the water supply. At the very least, samples of regulated water quality parameters should be collected to demonstrate that the process is effective.

Process reliability is another concern associated with start-up of a treatment plant. For this reason, the water treatment plant should initially send treated water to waste long enough to demonstrate that the process works reliably. The duration of sending treated water to waste can range from a few hours to a couple of days depending on the plant's treatment objective and treatment process(es) used. For biological processes, such as slow sand filtration, the plant may need to send treated water to waste for several weeks. The plant should identify provisions for waste disposal when it may produce large volumes of water as part of start-up.

The plant should test the critical alarms for on-line instrumentation by adjusting the water quality to the instrument, or the alarm set points to make sure the alarms function and all communication systems work. In addition, the plant should ensure that readings from the local instrument controller match the information recorded in the Supervisory Control and Data Acquisition (SCADA) system. See Section 10.4.2 for additional information on process control, including monitoring, instrumentation, and alarms.

In some cases, bringing a new treatment plant or significant process on-line may cause hydraulic and water quality changes to the distribution system. Hydraulic changes, such as flow reversals and changes in velocity and pressure in distribution system piping, can lead to suspension of sediments deposited in mains and cause the loss of chlorine residual, elevated turbidity, and customer complaints. Changes in water quality can cause sediments and metals to release from pipe surfaces. As a result, additional distribution system monitoring should be planned as part of placing a water treatment plant into service. This additional monitoring may include additional rounds of tap sampling as required under the Lead and Copper Rule (See Section 10.1.3 and 40 CFR 141.86(d)(4)(vii)).

Most water treatment facilities **must** complete additional start-up and testing requirements prior to certification of construction completion (WAC 246-290-120(4)). See Section 10.4.3 for more information on start-up and testing for water treatment facilities.

See Section 11.6 for additional information on placing a surface water treatment plant into service.

Table 10-4

**Waste Discharge Permitting Guidance for Water Treatment Plants Greater than or Equal to 35,000 gpd Average Daily Finished Water Production
Treatment is not IX, RO, or Slow Sand Filtration**

Waste Stream Characteristics (daily volume, content, etc.)	Disposal Method	Agency with Regulatory Oversight Authority
Wastewater (<u>not</u> the settled sludge) generated by filter backwash (including microfiltration and ultrafiltration), sedimentation/presedimentation basin washdown, sedimentation/clarification, and filter-to-waste processes	Discharge to surface water	Department of Ecology WTP General Permit
Wastewater (<u>not</u> the settled sludge) generated by filter backwash (including microfiltration and ultrafiltration), sedimentation/presedimentation basin washdown, sedimentation/clarification, and filter-to-waste processes	Discharge to ground	Department of Ecology Site-specific: May need a state waste discharge permit. Department of Health Wellhead protection requirements
Wastewater (<u>not</u> the settled sludge) generated by filter backwash (including microfiltration and ultrafiltration), sedimentation/presedimentation basin washdown, sedimentation/clarification, and filter-to-waste processes	Discharge to Publically Owned Treatment Works (POTW)	Local municipality or Department of Ecology
Settled sludge (from wastewater) generated by filter backwash (including microfiltration and ultrafiltration), sedimentation/presedimentation basin washdown, sedimentation/clarification, and filter-to-waste processes	Agronomic or silvicultural use	Land application: Local health jurisdiction Statewide Beneficial Use Determination: Department of Ecology
Settled sludge (from wastewater) generated by filter backwash (including microfiltration and ultrafiltration), sedimentation/presedimentation basin washdown, sedimentation/clarification, and filter-to-waste processes	Landfill	Local health jurisdiction

Table 10-5
Waste Discharge Permitting Guidance for Water Treatment Plants Less than 35,000 gpd
Average Daily Finished Water Production
Treatment is not IX, RO, or Slow Sand Filtration

Waste Stream Characteristics (daily volume, content, etc.)	Disposal Method	Agency with Regulatory Oversight Authority
Wastewater (<u>not</u> the settled sludge) generated by filter backwash (including microfiltration and ultrafiltration), sedimentation/presedimentation basin washdown, sedimentation/clarification, and filter-to-waste processes	Discharge to surface water	Department of Ecology No reasonable potential to pollute.
Wastewater (<u>not</u> the settled sludge) generated by filter backwash (including microfiltration and ultrafiltration), sedimentation/presedimentation basin washdown, sedimentation/clarification, and filter-to-waste processes	Discharge to ground	Department of Ecology No reasonable potential to pollute. Department of Health Wellhead protection policy.
Wastewater (<u>not</u> the settled sludge) generated by filter backwash (including microfiltration and ultrafiltration), sedimentation/presedimentation basin washdown, sedimentation/clarification, and filter-to-waste processes	Discharge to POTW	Local municipality or Department of Ecology
Settled sludge (from wastewater) generated by filter backwash (including - microfiltration and ultrafiltration), sedimentation/presedimentation basin washdown, sedimentation/clarification, and filter-to-waste processes	Agronomic or silvicultural use	Land application: Local health jurisdiction Statewide Beneficial Use Determination: Department of Ecology
Settled sludge (from wastewater) generated by filter backwash (including microfiltration and ultrafiltration), sedimentation/presedimentation basin washdown, sedimentation/clarification, and filter-to-waste processes	Landfill	Local health jurisdiction

Table 10-6

Waste Discharge Permitting Guidance for Water Treatment Plants for Any Treatment Plant using IX, RO, Microfiltration, Ultrafiltration, or Nanofiltration

Waste Stream Characteristics (daily volume, content, etc.)	Disposal Method	Agency with Regulatory Oversight Authority
IX, RO brine, or filter backwash that contains dissolved solids removed from the source water (consisting of regeneration liquid, ionic pollutants, and rinse water)	Discharge to surface water	Department of Ecology Individual NPDES permit, except for discharges from desalinization processes of up to 5,000 gpd to salt waters.
IX, RO brine, or filter backwash that contains dissolved solids removed from the source water (consisting of regeneration liquid, ionic pollutants, and rinse water)	Discharge to ground	Department of Ecology Site-specific: May need an NPDES individual permit or a state waste discharge permit.
IX, RO brine, or filter backwash that contains dissolved solids removed from the source water (consisting of regeneration liquid, ionic pollutants, and rinse water)	Discharge to POTW	Local municipality or Department of Ecology Site-specific: May need a state waste discharge permit.
IX, RO brine, or filter backwash that contains dissolved solids removed from the source water (consisting of regeneration liquid, ionic pollutants, and rinse water)	Agronomic or silvicultural use	Department of Ecology Site-specific: May need a state waste discharge permit.
Settled sludge (from wastewater) generated by filter backwash, sedimentation/presedimentation basin washdown, sedimentation/clarification, and filter-to-waste processes	Landfill or recycling	Local health jurisdiction

IX = Ion exchange.

RO = Reverse osmosis

The main assumption for this table is that wastes and discharges are "typical," i.e., they do not contain unusually large amounts of pollutants.

Single domestic or point-of-use IX or RO systems do not require a state waste discharge permit because Ecology considers them to have no reasonable potential to pollute.

**Table 10-7
Disinfection Treatment**

Established Technologies	Typical Application	Notes
Chlorine Gas	Primary or Secondary	Consumes alkalinity and may reduce pH. Requires a risk management plan if >2,500 lbs. stored on site (see 40 CFR 68). Use of gaseous chlorine may trigger an International Fire Code requirement for spill mitigation measures, such as containment or scrubbers. Proponents of new installation should coordinate this with the local fire prevention authority. Evaluate total trihalomethane (TTHM) and haloacetic acids five (HAA5) formation.
Hypochlorination	Primary or Secondary	Design should evaluate expected storage time and effect on solution strength, potential for strength dilution to minimize these problems; evaluate TTHM and HAA5 formation.
Chlorine Dioxide	Primary or Secondary	On site generation. Maximum allowable ClO ₂ concentration at entry = 0.8 mg/L (as ClO ₂), MCL for chlorite = 1.0 mg/L Use triggers additional monitoring for chlorine dioxide and chlorite.
Ozone	Primary	Pilot work required to determine decay and demand characteristics. May significantly increase biodegradable organic matter in treated water, which may require secondary disinfection. MCL for bromate = 0.010 mg/L.
Chloramines	Secondary	Background ammonia levels must be considered and requires close operator attention to ensure proper ammonia-chlorine ratio. Design must provide overfeed protection. Water systems proposing changeover from free chlorine should evaluate the potential for elastomer degradation (Reiber 1993).
Irradiation (UV light) See Appendix I	Primary	Minimum applied UV dose for groundwater applications is 186 mJ/cm ² for 4-log virus inactivation. Reactor validation uncertainties will require the applied reduction equivalent dose (RED) to be even greater than this threshold. If UV is the primary surface water disinfectant, a RED of at least 40 mJ/cm ² is required to inactivate <i>Giardia</i> with virus inactivation provided by chlorine. Additional information and guidance is available from EPA (USEPA 2006a) and DOH.
On-Site Hypochlorite Generation	Primary or Secondary	See notes for hypochlorination above. ANSI/NSF Standard 60 certified sodium chloride (salt) must be used to generate the hypochlorite solution. The design should address ventilation for hydrogen gas to minimize the risk of explosions.
Tablet Chlorinators	Primary or Secondary	See notes for hypochlorination above. Design should consider potential for variations in chlorine dosage.

Notes:

1. Primary disinfection used to inactivate pathogenic organisms from source water.
2. Secondary disinfection used to maintain a distribution system residual.
3. Disinfection performance requirements are detailed in chapter 246-290 WAC, Parts 5 and 6.

**Table 10-8
Corrosion Control Treatment**

Established Technologies	Notes
pH/alkalinity adjustment	
--Chemical Addition	Caustic soda (NaOH), lime (Ca(OH) ₂), soda ash (Na ₂ CO ₃), sodium bicarbonate (NaHCO ₃), calcium carbonate (CaCO ₃), potassium hydroxide (KOH) and carbon dioxide (CO ₂) (USEPA, 1992; Economic and Engineering Services, 1990).
--Calcite Contactor	Applies to small water systems (generally less than 500 people). No danger of chemical overfeed and is usually not operator intensive. Generally applies when Ca ²⁺ < 30 mg/L, alkalinity < 60 mg/L (both as CaCO ₃) and pH low (<7.2). Potential clogging due to Fe/Mn and other particulate matter. Waters with significant natural organic matter (>2 mg/L total organic carbon (TOC)) should be evaluated to ensure that organic deposits will not interfere with the dissolution of media over time.
--Aeration/Air Stripping	Suitable for groundwater high in CO ₂ , effectiveness controlled by alkalinity and aeration system design, capital costs usually high, pre- or post-aeration disinfection should be provided. Pilot work to verify design parameters must be completed (for example, height, packing, air and water ratio).
Calcium Carbonate Precipitation	Calcium carbonate precipitation is not a viable approach for corrosion control in the Pacific Northwest due to the region's relatively soft waters.
Inhibitors	
--Ortho - / Poly - / Blended Phosphates	Phosphate based inhibitors are pH sensitive, so the pH range should be maintained with the range of 7.2 to 7.8. Since phosphate can increase biological activity in the distribution system, disinfection may be required along with the addition of phosphates.
--Silicates	Sodium silicate inhibitors are not well understood (USEPA 1992; Reiber 1990). Silicate effectiveness thought to be a combination of concurrent pH increase and protective film on piping walls.

Table 10-9
Treatment Technologies for Selected IOCs

Established Technologies	Contaminant	Notes	References
Oxidation or Filtration	As, Fe, Mn	Oxidation kinetics are pH sensitive (principally Mn), organic matter will increase oxidant demand. Fe addition may be required to remove As. Filtration rates depend on filtration media, oxidant, and source water quality.	Hoffman et al. 2006; HDR 2001
Cation Exchange	Fe, Mn	Should not be used if the concentration of Fe and Mn combined exceeds 0.3 mg/L. Prevent oxidation of Fe and Mn prior to ion exchange or resin will foul. Waste disposal of brine may be an issue.	Ten State Standards 2012
Anion Exchange	As, NO ₃	Use nitrate selective resin (for NO ₃), As: Oxidize As(III) to As(V). Competition with sulfate and other ions must be evaluated. Total dissolved solids should be <500 mg/L. Post-column pH adjustment required. Evaluate waste disposal issues.	Clifford 1999; USEPA 2003; WSDOH 2018a
Activated Alumina	F	pH adjustment required to maximize adsorption, pH adjustment not recommended for small water systems due to operational complexity and safety issues.	Clifford 1999
Iron Based and Other Specialized Adsorbents	As	Performance of adsorbents varies with vendor and water quality. Some adsorbents do not remove As(III). If As(III) is present, preoxidation may be required.	USEPA 2003
Reverse Osmosis (RO)	As, F, Fe, Mn, NO ₃	Posttreatment corrosion control may be required, high operation cost, sizing strongly temperature sensitive, concentrate disposal issues must be evaluated. As(III) should be oxidized to As(V). Side stream blending may be appropriate.	USEPA 2005; USEPA 2003
Sequestration	Fe, Mn	For source water with a combined Fe/Mn concentration of less than 1.0 mg/l (Mn < 0.1 mg/l). May apply at higher concentrations; however, those applications should conduct bench scale studies and will be allowed only on existing sources. Disinfection required.	Robinson et al. 1990; HDR 2001; Ten State Standards 2012.
Alternative Technologies	Contaminant	Notes	References
Biological Removal	NO ₃ , Fe, Mn	Not in widespread use in the United States. Substantial pilot work (1 year continuous operation at a minimum) would be required to establish biological process, and posttreatment disinfection must be provided. Taste and odor control issues.	HDR 2001; WSDOH 2018a

Notes:

1. Pilot testing is expected for all technologies listed above. See Section 10.3 for additional pilot testing information.
2. The listed technologies may be capable of removing other inorganic chemicals. Contaminants are listed in this column if typical removal rates for the specific technology are expected to exceed 70 percent in most applications as indicated in selected references.

3. Manufactured media and equipment must meet the requirements of WAC 246-290-220.
4. Processes listed above are expected to require a minimum of 6 to 8 hours per week of operator involvement, although some may require more. Water systems proposing to install a treatment system should contact existing facilities and participate fully in pilot work to better assess long-term operator needs.
5. Appropriate instrumentation or control may include automatic plant shut down for process equipment and pump failure, auto-dialers or similar equipment to alert 24-hour on-call personnel of plant failures, on-line filtered or finished water monitoring equipment, and automatic filter-to-waste capability.

Table 10-10
Treatment Technologies for VOCs and SOCs

Technologies	Notes
Granular Activated Carbon (GAC)	A best available technology for VOC and SOC removal. May require prefiltration to remove particulate matter. Competition for GAC sorption sites with natural organic matter may occur. Seasonal increases in competing species may cause desorption of contaminant and must be fully evaluated. Requires reactivation of carbon on a regular basis (site and contaminant specific).
Powdered Activated Carbon (PAC)	May be effective for VOC and SOC removal, must provide adequate mixing and contact time, existing settling and filtration must effectively remove added PAC. May be used seasonally if problem is not continuous. EPA considers PAC an "emerging" technology for VOC removal (USEPA 1998).
Aeration	A best available technology for VOC removal and some of the more volatile SOCs. Established technologies include packed tower, diffused, and multiple tray aeration. Some alternative configurations require evaluation through pilot studies (see WAC 246-290-250). Design goals and operational parameters control performance. Aerated water should be disinfected to prevent significant growth of heterotrophic plate count bacteria (Umphres et al. 1989).
Chlorine or Ozone oxidation	Applies to glyphosate only. See Disinfection Section for specific issues related to these technologies.

Notes:

1. Pilot testing is required for all technologies listed above, and may be required over periods of varying water temperature, and varying contaminant concentrations, if applicable. See Section 10.3 below for additional pilot testing information.
2. Manufactured media and equipment must meet the requirements of WAC 246-290-220.

Table 10-11
Treatment Technologies for Reduction of DBPs

Precursor Removal	Notes
Enhanced Coagulation	Suitable only for conventional surface water plants. Nature of source water organic material, treatment conditions (coagulation pH) and background alkalinity control effectiveness. Requires significant coagulant doses. Required treatment technique according to the Stage 1 D/DBP Rule for surface water treatment plants that use conventional rapid rate filtration.
Granular Activated Carbon	GAC10 (empty bed contact time of 10 minutes) and reactivation period of carbon of no more than every six months. This is a best available technology for removing DBP precursors, although performance depends on the selected GAC and the nature of the organic matter to be removed.
Powdered Activated Carbon (PAC)	Suitable for conventional rapid rate surface water plants and potentially membrane plants. Effectiveness depends on the nature of the organic matter present; this must be demonstrated through a long-term pilot study (at least 1 year of operation).
Biologically Active Filtration	Use preozonation followed by a rapid rate filtration process. Filter media may be GAC, anthracite, sand, or some combination. TOC removal in the 20 to 70 percent range possible, dependent on the nature of the organics present, ozone dose, and filter contact time (Carlson and Amy 1998).
Slow Sand Filtration	Standard slow sand filtration expected to remove 5 to 25 percent of source water organic matter (as TOC). Using preozonation will increase removal; however, a long-term pilot is required (at least 1 year of operation) to determine effectiveness and effect on filter cleaning requirements (Eighmy et al. 1993).
Membranes	Nanofiltration can effectively remove DBP precursors. Unamended ultra- or microfiltration will not generally remove precursors. Use of PAC in ultrafiltration water systems has been effectively demonstrated (AwwaRF et al. 1996).
DBP Removal or Mitigation	
Aeration	Some volatile DBP (such as chloroform) can be significantly removed through appropriately designed aeration processes (Billeo et al. 1986; Walfoort et al. 2008). Temperature and air-water ratio are significant design factors.
Alternative Disinfection or Application	Using chloramines in distribution systems with long detention times, ozone, or chlorine dioxide as a primary disinfectant may sufficiently mitigate the formation of regulated DBPs. See Table 10-4 for issues specific to these approaches.

References

ALA. 2002. *Seismic Design and Retrofit of Piping Systems*. American Lifelines Alliance.

ALA 2004. *Guide for Seismic Evaluation of Active Mechanical Equipment*. American Lifelines Alliance.

American Water Works Association Research Foundation, Lyonnaise des Eaux, and Water Research Commission of South Africa. 1996. *Water Treatment Membrane Processes*. McGraw-Hill: New York, NY.

ASCE 7. American Society of Civil Engineers, 2016, *Minimum Design Loads and Associated Criteria for Buildings and Other Structures*, ASCE/SEI 7-16, ISBN 9780784414248.

AWWA. 1993. "Fluoride Overfeed Can Have Serious Consequences." *AWWA Opflow*.

AWWA. 1999. *Water Quality & Treatment* 5th Edition, Chapter 16 "Water Treatment Plant Residuals Management," McGraw-Hill. New York, NY.

AWWA. 2016. *Water Fluoridation Principles and Practices*, 6th Edition: AWWA Manual M4. American Water Works Association, Denver, CO.

AWWA and American Society of Civil Engineers (ASCE). 1990. *Water Treatment Plant Design*, 2nd Edition, Chapter 11 "Iron and Manganese Removal," McGraw-Hill. New York, NY.

AWWA and American Society of Civil Engineers (ASCE). 2012. *Water Treatment Plant Design*, 5th Edition, McGraw-Hill. New York, NY.

——, (a) Chapter 4. Design and Construction

——, (b) Chapter 14. Ion Exchange Applications

——, (c) Chapter 18. Process Residuals

——, (d) Chapter 19. Pilot Plant Design and Construction

——, (e) Chapter 20. Chemical Systems

——, (f) Chapter 29. Design Reliability Features

——, (g) Chapter 33. Water Treatment Plant Construction Cost Estimating

Billeo, J. and J.E. Singley. 1986. "Removing Trihalomethanes by Packed-Column and Diffused Aeration," *Journal AWWA*, Vol. 78, Issue 2, pp. 62-71.

Boyd, G. R., Dewis, K. M., Korshin, G. V., Reiber, S. H., Schock, M. R., Sandvig, A. M., & Giani, R. 2008. Effects of changing disinfectants on lead and copper release. *Journal AWWA*, Vol. 100, Issue 11, pp. 75-87.

Brender, J.D., et al. 1998. "Community Exposure to Sodium Hydroxide in a Public Water Supply," *Environmental Health*, pp. 21-24.

Carlson, K.H. and G.L. Amy. 1998. "BOM Removal During Biofiltration," *Journal AWWA*, Vol. 90, Issue 12, pp. 42-52.

Clifford, D. and X. Liu. 1993. "Ion Exchange for Nitrate Removal," *Journal AWWA*, Vol. 85, Issue 4, pp. 135-143.

Clifford, D.A. 1999. *Water Quality and Treatment: A Handbook for Community Water Supplies*, 5th Edition, Chapter 9: Ion Exchange and Inorganic Adsorption, McGraw-Hill, New York, NY.

Cummings, L. and R.S. Summers. 1994. "Using RSSCTs to Predict Field-Scale GAC Control of DBP Formation," *Journal AWWA*, Vol. 86, Issue 6, pp. 88-97.

Economic and Engineering Services, Inc. 1990. *Lead Control Strategies*, AWWA Research Foundation, Denver, CO.

Edwards, M., & Dudi, A. 2004. Role of chlorine and chloramine in corrosion of lead-bearing plumbing materials. *Journal AWWA* Vol. 96, No. 10. pp 69-81.

Edwards, M., and S Triantafyllidou. 2007. Chloride-to-sulfate mass ratio and lead leaching to water. *Journal AWWA*, Vol. 99, No. 7. pp. 96-109.

Eighmy, T.T., M.R. Collins, J.P. Malley, J. Royce, and D. Morgan. 1993. *Biologically Enhanced Slow Sand Filtration for Removal of Natural Organic Matter*, AWWA Research Foundation, Denver, CO.

- Faust, S.D. and O.M. Aly. 1998. *Chemistry of Water Treatment*, 2nd Edition, Chapter 9: "Removal of Inorganic Contaminants," Ann Arbor Press, Chelsea, MI.
- Fawell, J., K. Bailey, J. Chilton, E. Dahi, L. Fewtrell and Y. Magara. 2006. *Fluoride in Drinking-water*, International Water Association Publishing, London, UK.
- Ford, R., M. Carlson and W.D. Bellamy. 2001. "Pilot-testing with the End In Mind," *Journal AWWA*, Vol. 93, Issue 5, pp. 67-77.
- Gehling, D., D. Chang, J. Wen, Y. Chang, and B. Black. 2003. "Removal of Arsenic by Ferric Chloride Addition and Filtration," Proceedings AWWA Annual Conference, Anaheim, CA.
- Great Lakes-Upper Mississippi River Board of State and Provincial Public Health and Environmental Managers. 2012. Ten State Standards - *Recommended Standards for Water Works*. Health Education Service, Albany, NY.
- HDR Engineering, Inc. 2001. *Handbook of Public Water Supplies*, 2nd Edition, Chapter 14: "Iron and Manganese Removal," John Wiley & Sons, New York, NY.
- Hoffman, G.L., D.A. Lytle, T. J. Sorg, A.S.C. Chen, and L. Wang. 2006. *Removal of Arsenic from Drinking Water Supplies by Iron Removal Process*, EPA 600-R-06-030.
- Jensen, V.B., Darby, J.L., Seidel, C. and Gorman, C. 2012. Drinking Water Treatment for Nitrate. Technical Report 6 in: *Addressing Nitrate in California's Drinking Water with a Focus on Tulare Lake Basin and Salinas Valley Groundwater. Report for the State Water Resources Control Board Report to the Legislature*. University of California, Davis, CA.
- Kawamura, S. 2000a. *Integrated Design and Operation of Water Treatment Facilities*, 2nd Edition, John Wiley & Sons, New York, NY.
- Kawamura, S. 2000b. *Integrated Design and Operation of Water Treatment Facilities*, 2nd Edition, Chapter 2: "Preliminary Studies," John Wiley & Sons, New York, NY.
- Kippin, S. J., J.R. Pet, J.S. Marshall, and J.M. Marshall. 2001. *Water Quality Impacts from Blending Multiple Water Types*, AWWA Research Foundation, Denver, CO.
- Kohl, P., and S. Medlar 2006. *Occurrence of Manganese in Drinking Water and Manganese Control*. AWWARF, Denver, CO.

- Kumar, M., S. Adham, and W. Pearce. 2006. "Developing a Protocol to Evaluate New-Generation Membranes for Desalting Brackish Groundwater," *Journal AWWA*, Vol. 98, Issue 4, pp. 122-132.
- Lee, S.H., D.A. Levy, G.F. Craun, M.J. Beach, and R.L. Calderon. 2002. "Surveillance for Waterborne Disease Outbreaks - United States 1999-2000," *CDC Morbidity and Mortality Weekly Report*.
- Liang, S., M.A. Mann, G.A. Guter, P.H.S. Kim, and D.L. Hardan. 1999. "Nitrate Removal from Contaminated Groundwater," *Journal AWWA*, Vol. 91, Issue 2, pp. 79-91.
- Logsdon, G., S. LaBonde, D. Curley, and R. Kohne. 1996. Pilot-Plant Studies: From Planning to Project Report, *Journal AWWA*, Vol. 88, Issue 3, pp. 56-65.
- Nguyen, C., Stone, K., Clark, B., Edwards, M., Gagnon, G., & Knowles, A. 2010. Impact of chloride: sulfate mass ratio (CSMR) changes on lead leaching in potable water. *Water Research Foundation, Denver, CO*.
- Pacific Northwest Section - American Water Works Association. 1996. *Cross Connection Control: Accepted Procedure and Practice Manual*, 6th Edition, PNWS-AWWA, Clackamas, OR.
- Pisigan, R.A., and J.E. Singley. 1987. Influence of Buffer Capacity, Chlorine Residual, and Flow Rate on Corrosion of Mild Steel and Copper. *Journal AWWA*, Vol. 79, Issue 2, pp. 62-70.
- Reeves, T.G. 1986. *Water Fluoridation: A Manual for Engineers and Technicians*, U.S. Dept of Health and Human Services, Public Health Service, CDC, Atlanta, GA.
- Reiber, S., M. Benjamin, J. Ferguson, E. Anderson, and M. Miller. 1990. *Chemistry of Corrosion Inhibitors in Potable Water*, AWWA Research Foundation, Denver, CO.
- Reiber, S. 1993. "Investigating the Effects of Chloramine on Elastomer Degradation," *Journal AWWA*, Vol. 85, Issue 8, pp. 101-111.
- Robinson, R.B., G.D. Reed, D. Christodos, B. Frazer, and V. Chidambariah. 1990. *Sequestering Methods of Iron and Manganese Treatment*, American Water Works Association Research Foundation and American Water Works Association, Denver, CO.

- Sanks, R. L., G. Tchbanoglous, B.E. Bosserman, G. M. Jones. 1998. *Pumping Station Design*, 2nd Edition, Butterworth Heineman, Boston, MA.
- Schock, M.R. & Lytle, D.A., 2011 *Chapter 17 - Internal Corrosion and Deposition Control. Water Quality and Treatment: A Handbook of Drinking Water - 6th ed..* McGraw-Hill, New York, NY.
- Seidel, C., C. Gorman, J.L. Darby, and V.B. Jensen. 2011. *An Assessment of the State of Nitrate Treatment Alternatives*. AWWA, Denver, CO.
- Sommerfeld, E.O. 1999. *Iron and Manganese Removal Handbook*, AWWA, Denver, CO.
- Stone, A., Spyridakis, D., Benjamin, M., Ferguson, J., Reiber, S., & Osterhus, S. 1987. The effects of short-term changes in water quality on copper and zinc corrosion rates. *Journal AWWA*, Vol. 79, Issue 2, pp. 75-82.
- Taylor, J.S., J.D. Dietz, A.A. Randall, S.K. Hong, C.D. Norris, L.A. Mulford, J.M. Arevalo, S. Imran, M. Le Puil, S. Liu, I. Mutoti, J. Tang, W. Xiao, C. Cullen, R. Heaviside, A. Mehta, M. Patel, F. Vasquez, and D. Webb. 2005. *Effects of Blending on Distribution System Water Quality*, AWWA Research Foundation, Denver, CO.
- Umphres, M.D. and J.H. Van Wagner. 1989. *An Evaluation of the Secondary Effects of Air Stripping*, EPA 600-2-89-005.
- USEPA. 1990. *Guidance Manual for Compliance with the Filtration and Disinfection Requirements for Public Water Systems Using Surface Water Sources "Appendix E: Inactivation Achieved by Various Disinfectants"* EPA Contract No. 68-01-6989.
- USEPA. 1992. *Lead and Copper Guidance Manual Volume 2: Corrosion Control Treatment*, EPA 811-R-92-002.
- USEPA. 1998. *Small System Compliance Technology List for the Non-Microbial Contaminants Regulated Before 1996*, EPA 815-R-98-002 .
- USEPA. 1999 (a). *Alternative Disinfectants and Oxidants Guidance Manual*, EPA 815-R-99-014.
- USEPA. 1999 (b). *Microbial and Disinfection Byproduct Rules Simultaneous Compliance Manual*, EPA 815-R-99-015.

- USEPA. 2001. *The Stage 1 Disinfectants and Disinfection Byproducts Rule: What does it mean to you?*, EPA 816-R-01-014.
- USEPA. 2003. *Arsenic Treatment Technology Evaluation Handbook for Small Water Systems*, EPA 816-R-03-014.
- USEPA. 2005. *Membrane Filtration Guidance Manual*, EPA 815-R-06-009.
- USEPA. 2006 (a). *Ultraviolet Disinfection Guidance Manual for the Final Long Term 2 Enhanced Surface Water Treatment Rule*, EPA 815-R-06-007.
- USEPA. 2006 (b). *A System's Guide to the Management of Radioactive Residuals from Drinking Water Treatment Technologies*, EPA 816-F-06-012.
- USEPA. 2012. *2012 Edition of the Drinking Water Standards and Health Advisories*. EPA 822-S-12-001.
- USEPA. 2016. *Optimal Corrosion Control Treatment Evaluation Technical Recommendations for Primacy Agencies and Public Water Systems*. EPA 816-B-16-003
- Wahman, D. G. 2018. "Chlorinated cyanurates: Review of water chemistry and associated drinking water implications." *Journal AWWA*, Vol. 110, Issue 9, E1-E15
- Walfoort, C., M. J. Messina, and D. Miner. 2008. "Storage Tank Aeration Eliminates Trihalomethanes," *AWWA Opflow*, Vol. 34, No. 5, pp. 28-29.
- Westerhoff, P., D. Highfield, M. Badruzzaman, Y. Yoon, and S. Raghavan. 2003. "Rapid Small Scale Column Tests for Arsenate Removal in Iron Oxide Packed Bed Columns." *AWWA Annual Conference*, Anaheim, CA.
- WSDOH. 2007. *Point-of-Use or Point-of-Entry Treatment Strategy*, DOH 331-358, Washington State Department of Health, Olympia, WA.
- WSDOH. 2013. *Testing Critical Alarms*, DOH 331-472, Washington State Department of Health, Olympia, WA.
- WSDOH. 2018a. *Nitrate Treatment: Alternatives for Small Water Systems*, DOH 331-309, Washington State Department of Health, Olympia, WA.

WSDOH. 2018b. *Monitoring Surface Water Treatment Processes*, DOH 331-620,
Washington State Department of Health, Olympia, WA.

Chapter 11: Surface Water Treatment

11.0 Introduction

This chapter covers important concepts unique to the design of treatment facilities for surface water sources and sources designated as groundwater under the direct influence of surface water (GWI). Surface water and confirmed GWI sources must meet the same regulatory requirements and are synonymous throughout this section. These sources carry a high microbial risk. As a result, the basic treatment framework requires the following minimum level of treatment always be achieved:

- 2-log removal or inactivation of *Cryptosporidium* oocysts,
- 3-log removal or inactivation of *Giardia lamblia* cysts, and
- 4-log removal or inactivation of viruses.

For poor quality surface water sources with the highest risk of contamination, and for water systems seeking approval for a *Limited Alternative to Filtration* (see [Policy F.10](#)), Washington state rules may require a greater level of treatment than the basic framework of federal rules outlined above.

Washington's basic regulatory requirements for surface water treatment facilities are in Chapter 246-290 WAC Part 6. These requirements stem from multiple federal rules developed over the past three decades. They include the Surface Water Treatment Rule (SWTR), Interim Enhanced Surface Water Treatment Rule (IESWTR), Long Term 1 Enhanced Surface Water Treatment Rule (LT1ESWTR), Filter Backwash Recycle Rule (FBRR), and Long Term 2 Enhanced Surface Water Treatment Rule (LT2ESWTR). Effective implementation of these rules and consumer protection depends on a multiple barrier framework:

- Effective source-water protection, filtration, and disinfection.
- Maintenance of treated water quality within the distribution system.
- Trained and properly certified operators to oversee the process.

This chapter is similar to Chapter 10, with the following sections narrowly tailored to surface water treatment issues:

- Alternatives Analysis (Section 11.1).
- Treatment Technologies (Section 11.2) including:
 - Clarification and Sedimentation.
 - Filtration.
 - Disinfection.

- Predesign Studies (Section 11.3) including pilot studies.
- Project Reports (Section 11.4) including identifying:
 - Design Criteria.
 - Process Control: Monitoring, Instrumentation, and Alarms.
 - Start-up and Testing Procedures.
 - Operations and Staffing.
 - Process Reliability.
- Operations Program (Section 11.5).
- Placing a Surface Water Treatment Plant into Service (Section 11.6).

Design engineers should familiarize themselves with the contents of Chapter 10; it covers some design topics not covered elsewhere.

- Construction Documents (Section 10.5)
- Treatment Chemicals (Section 10.6)
- Cross Connection for Water Treatment Facilities (Section 10.7)
- Waste Residuals Management (Section 10.8)

Design engineers need to consider many factors in developing surface water treatment projects. Source water quality and quantity will change seasonally and from year to year. In addition, surface waters have a greater microbial risk than groundwater sources. Therefore, the design process may be iterative and require a more thorough characterization of the source water, longer and more detailed pilot studies, and a well-planned commissioning process. As such, it takes much longer to develop a surface water treatment project than it takes to develop other types of projects. Figure 2-3 outlines the general design and review process for water treatment projects.

11.1 Alternatives Analysis

A surface water treatment facility is a major capital investment with high life-cycle costs and a potential high risk to public health if treatment processes fail to operate as intended. Therefore, the engineer **must** evaluate all appropriate and applicable alternatives before selecting a particular treatment technology and design approach (WAC 246-290-110(4)(c)).

The engineer should cover the following items in the alternatives analysis and apply the detailed guidance provided in professional references:

- Source capacity and projected demands.

- Source water protection.
- Source water quality.
- Operational complexity, reliability, and staffing.
- Secondary effects of water treatment (see Chapter 10).
- Waste disposal and management (see Chapter 10).
- Life cycle costs (see Chapter 10).

11.1.1 Source Capacity and Projected Demands

Surface water sources are more prone to changes in flow from year to year than groundwater sources. In addition, some watersheds are experiencing prolonged hydrologic shifts as a result of global warming (Mote et al. 2005). These hydrologic shifts include reduced snowpack and lower summer stream flows. Logging, wildfires, and changes in land use also can cause adverse hydrologic shifts. In some cases, it may be necessary to evaluate these hydrologic shifts when assessing the safe yield of the water supply. In general, the safe yield of a surface water supply is the reliable withdrawal rate of water that a watershed can provide through the critical drought period. See Section 5.8.1 for additional information on assessing the safe yield of surface water supplies.

Periodically, filters need to be taken out of service for backwashing (rapid rate filtration), filter scraping and ripening (slow sand filtration), recovery cleaning (membrane filtration), and general maintenance (all types of treatment). Because water systems cannot always schedule these activities for periods of low demand, the design engineer should consider the production capacity of the treatment process and the ability to satisfy consumer demand with one filter out of service. In addition, water consumed during backwash and filter to waste should be considered when analyzing the overall process capacity, both on a daily and annual basis. See Chapter 4 for guidance on establishing water system capacity.

11.1.2 Source Water Protection

Source water protection is an important barrier in the multiple barrier framework to protect consumers from risks associated with surface water. As such, engineers **must** develop a watershed control program for all surface water and GWI sources and include it in the planning document for the water system (WAC 246-290-135(4)). The overall purpose of the watershed control program is to assess and reduce microbial and chemical contaminant risk in the source(s) supplying a treatment plant. Poor source water protection can increase risks from pathogens, algae, and chemicals (pesticides and herbicides), and present other risks and treatment challenges.

11.1.3 Source Water Quality

Source water and finished water quality objectives form the primary basis for selecting treatment process alternatives. Higher quality sources present lower risks to public health and are usually less expensive to treat, both initially and over the long term. Therefore, water systems **must** obtain their source of supply from the highest quality source feasible (WAC 246-290-130(1)). Engineers and water systems should consider that logging, forest fires, and changes in land use could cause changes in water quality (higher turbidity) and microbiological risks.

The extent and availability of raw water data may affect preliminary screening of alternatives and the duration of the pilot study. Surface water and GWI sources can experience rapid and seasonal changes in water quality. Source water characterization should account for source water quality variability. For most surface water sources, the design engineer should have at least one year of water quality information before making a preliminary treatment method determination.

The scope of source water sampling will vary depending on the type of source water, location of the intake, seasonal changes, and other issues. For example, rivers and streams can experience rapid changes in turbidity and inorganic parameters associated with changes in precipitation and runoff. Lakes and reservoirs often experience seasonal water quality changes associated with algae growth, lake stratification, and turnover. Basic water quality information needed to plan appropriately for a water treatment facility includes:

- **Turbidity:** High turbidity can rapidly clog filters, triggering frequent backwashes and other operational issues such as coagulant demand and control. For these reasons, engineers should compile daily maximum and average monthly turbidity data for the source water.
- **Temperature:** Low temperature makes water more viscous, affecting head loss through filters (especially membrane filters) and the ripening time for slow sand filters. Temperatures less than 8°C can be challenging for rapid rate filtration (Kawamura 1999). Low temperature affects chemical disinfection processes, requiring more contact time or higher disinfectant residual concentrations to meet pathogen inactivation requirements.
- **Microbiological Risk:** The Long Term 2 Enhanced Surface Water Treatment Rule **requires** all surface water sources to undergo source water quality monitoring to assess microbial risk. For a new source, the water system **must** submit to DOH a sample location description and schedule for monitoring planned under the LT2ESWTR (WAC 246-290-630(16)). The water system should include results of this monitoring in the project report. The concentration of coliform in the source

water can also be useful in determining the suitability of various filtration technologies.

- **Inorganic Parameters:** Engineers should assess the seasonal variability of pH along with regulated inorganic contaminants. Some surface water treatment processes are sensitive to the pH and alkalinity of the source water. Surface waters in parts of Washington may require added alkalinity for effective and stable treatment. Conversely, the efficacy of free chlorine as a disinfectant decreases as pH increases. For lakes and reservoirs, seasonal turnover can result in sudden increases in iron and manganese. Significant changes in pH also can indicate algal issues with a source water.
- **Volatile and Synthetic Organic Contaminants (VOCs and SOCs):** We require a complete set of samples for VOCs and SOCs as part of the approval process for any new surface water source. Engineers should consider detection of a regulated VOC or SOC in source water in their watershed risk assessment, and address it in their treatment objectives.
- **Total Organic Carbon (TOC):** Natural organic matter can lead to the formation of disinfection byproducts. Natural organic matter measured in milligrams per liter (mg/L) of TOC or dissolved organic carbon (DOC) often turns water a pale tea color. UV absorbance at 254nm (UV₂₅₄) is a good surrogate indicator of TOC and DOC once the relationship between UV₂₅₄ and TOC and DOC is established for a given source water. Analyzing for UV₂₅₄ is less expensive, less complicated, and easy to do onsite.
- **Algae and Chlorophyll-a:** Algae can cause filter-clogging, changes in source water pH, and taste and odor issues. Algae can be a health concern; some species of cyanobacteria (called blue-green algae) can produce toxins. It may be appropriate to identify and enumerate phytoplankton, including algae, seasonally and as frequently as weekly, especially in lakes prone to stratification and turnover. Chlorophyll-a is an inexpensive surrogate for assessing the abundance of algae in a surface water supply. Phycocyanin is another possible surrogate, though it is specific to cyanobacteria and currently can only be monitored using in-situ probes and satellites.

After thoroughly characterizing the source water quality, the design engineer can assess the most appropriate surface water filtration technologies. See Table 11-1 for design guidance on source water quality limitations for various filtration technologies. Pretreatment processes can allow for greater levels of coliform, color, or turbidity than listed below. See Section 11.2.1 for additional information about pretreatment technologies.

Table 11-1
General Source Water Limitations for Filtration Technologies

Filtration Technology	Turbidity (NTU) ¹	Total Coliform (#/100 mL) ¹	Color (CU) ¹
Conventional Filtration	<3000	<5,000 – 20,000	< 75
Direct Filtration	< 15	<500	< 40
In-line Filtration	<15	<500	<10
Slow Sand Filtration ²	< 10	<800	< 5
Diatomaceous Earth Filtration	< 5	<50	< 5
Pressure Filtration ³	DO NOT USE		
Bag and Cartridge Filtration ²	< 5	See Note 4	See Note 4
Membrane Filtration	See Note 4	See Note 4	See Note 4

¹ The water quality limitations derived from a combination of sources, including Letterman, 1986; USEPA 1975; Cleasby et al. 1984; AWWA/ASCE 2012b.

² These limits are for applied filter turbidity. The treatment process can handle higher source water turbidities if additional pretreatment is provided.

³ According to Section 4.2.2 *Recommended Standards for Water Works* (Ten State Standards 2012), pressure filters are for iron and manganese removal, and **must not** be used for filtration of surface water.

⁴ Special studies are required to determine limitations, which are equipment specific.

11.1.4 Operational Complexity and Staffing

We expect systems to choose the simplest available technology that can effectively and efficiently treat the source water quality. Surface water treatment technologies vary in their operational complexity and staffing needs. For example, rapid rate filtration is much more mechanically and operationally complex than slow sand filtration. Rapid rate filtration process upsets or failures are more likely to occur and can cause significant risks to public health. Such complex treatment processes usually require closer operational oversight and more operator time than simpler processes. More complex treatment processes also require a higher level of operator certification.

Finding appropriately trained and certified staff can be difficult for some water systems. Engineers should address operational and staffing considerations as part of the alternatives analysis. Most small communities struggle to find and retain operators with the skills and qualifications needed to operate complex filtration technologies.

Data from rapid rate filter plants that serve small communities (less than 3,300 people) show poorer performance when compared to larger plants (see Figure 11-1). Equally troubling, in several cases, small plant performance degraded suddenly and dramatically when staff changes occurred. For these reasons, rapid rate filtration is not an appropriate choice for small systems. The only exception is when a community is committed to providing at least one full-time qualified operator dedicated exclusively to

the plant and one backup operator to cover weekends, holidays, sick and vacation leave, and time necessary to complete mandatory operator training.

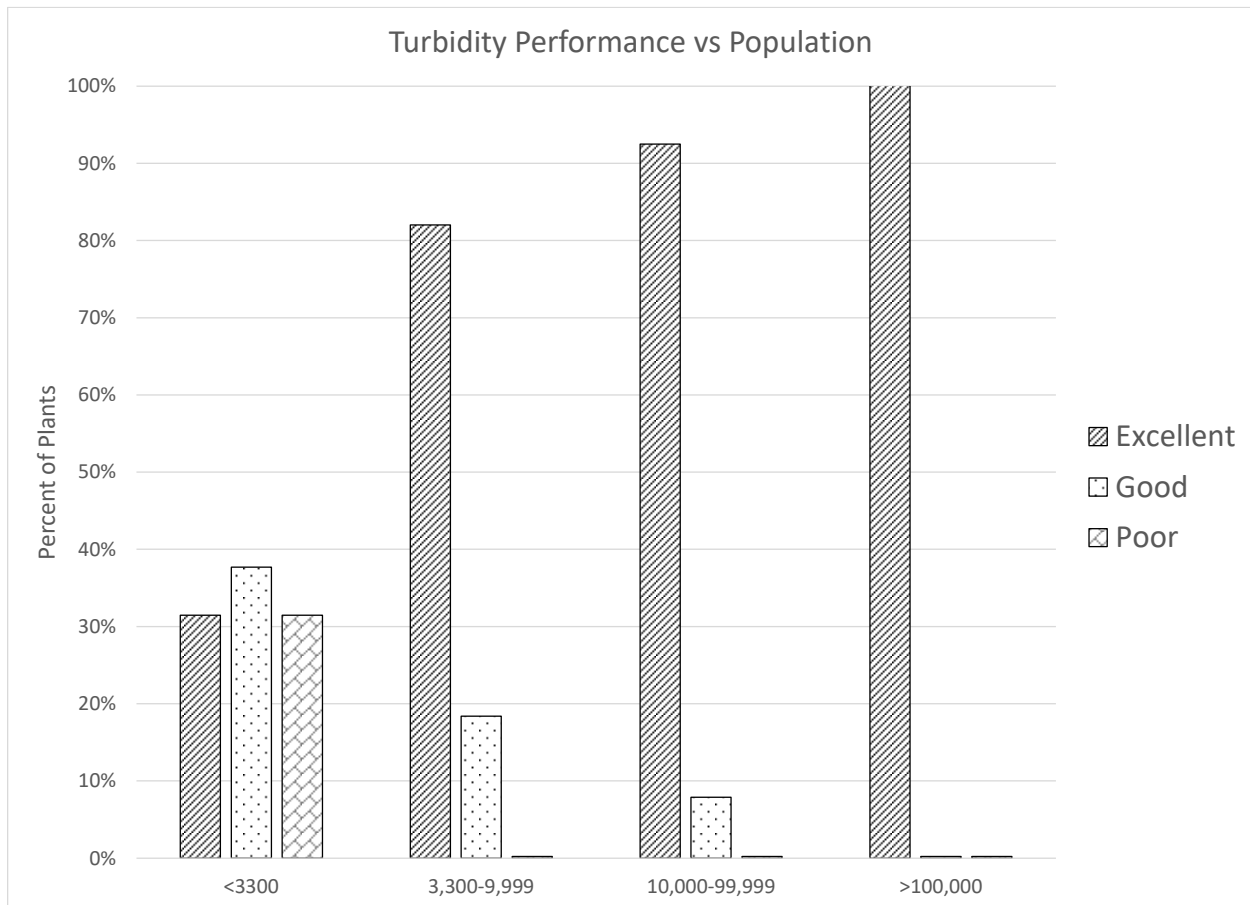

Figure 11-1: Rapid Rate Filtration Turbidity Performance in Washington, 2017.

See Section 11.4.4 for additional information on operational and staffing considerations for various surface water treatment technologies.

11.2 Treatment Technologies

As noted above, the engineer’s treatment technology evaluation should consider source water quality and other factors, including space availability, treatment complexity, and cost. Multiple barriers are used to meet surface water treatment requirements including:

- Screening and Prefiltration (Section 11.2.1).
- Chemical Addition (Section 11.2.2).
- Clarification and Sedimentation (Section 11.2.3).
- Filtration (Section 11.2.4).
- Disinfection (Section 11.2.5).

These are typical processes that protect public health by removing and inactivating pathogens. However, surface water treatment can provide other benefits, too, such as removing disinfection byproduct (DBP) precursors, organic chemicals, inorganic chemicals, and taste and odor causing compounds. More information about removing these compounds is in Section 10.2.

11.2.1 Screening and Prefiltration

Bag, cartridge and membrane filters often require screening and prefiltration to prevent rapid fouling of or damage to the filters. Other treatment technologies use screens to minimize the potential for damage to equipment, such as pumps, valves, and the filters themselves. The manufacturer of the downstream filtration or prefiltration equipment may identify the size and type of screening. For membrane filtration, self-cleaning screens in the 200 to 500 micron (μm) range are often used. For bag filtration, a series of prefilters with nominal pore sizes of 25 to 2 μm are commonly used. Other types of prefiltration, such as roughing filters, can be used to extend the run times for downstream filtration processes. All types of screening and prefiltration equipment should be equipped with a way to measure the differential pressure or head loss across the units.

11.2.2 Chemical Addition

Adding a chemical upstream can affect many clarification, filtration, and disinfection processes. For some processes, such as rapid rate filtration, chemical addition is essential. Without closely controlled chemical addition, rapid rate filtration does not provide effective pathogen reduction.

Several chemicals are used to make surface water treatment processes function effectively, including oxidants, coagulants, and other specialized chemicals, such as powdered activated carbon used for taste and odor control.

One key aspect of the predesign process is to identify the type and dose range of oxidants, coagulants, and other chemicals needed to make downstream treatment processes function most effectively. Any chemical used in a surface water treatment facility **must** be ANSI/NSF Standard 60 approved and applied within its maximum application dosage (WAC 246-290- 220(3)). See below for more information on chemical addition for specific unit processes. Also see Section 10.6 for general design information on chemical feed systems.

11.2.3 Clarification and Sedimentation

Water systems use clarification and sedimentation processes upstream of filtration processes to remove pathogens, turbidity, and other materials that can clog filters. Common clarification and sedimentation processes include:

- Ballasted sedimentation.
- Contact adsorption clarification.
- Dissolved air flotation.
- Gravity sedimentation, usually with tube or plate settlers.

In general, sedimentation processes are well suited to source waters from rivers and other very turbid surface waters, while dissolved air flotation is well suited for lakes, especially ones with high concentrations of algae or organic carbon (Figure 11-2). Engineers should provide turbidity meters, level sensors, and flow monitoring on each treatment train so operators can observe and control sedimentation and clarification processes.

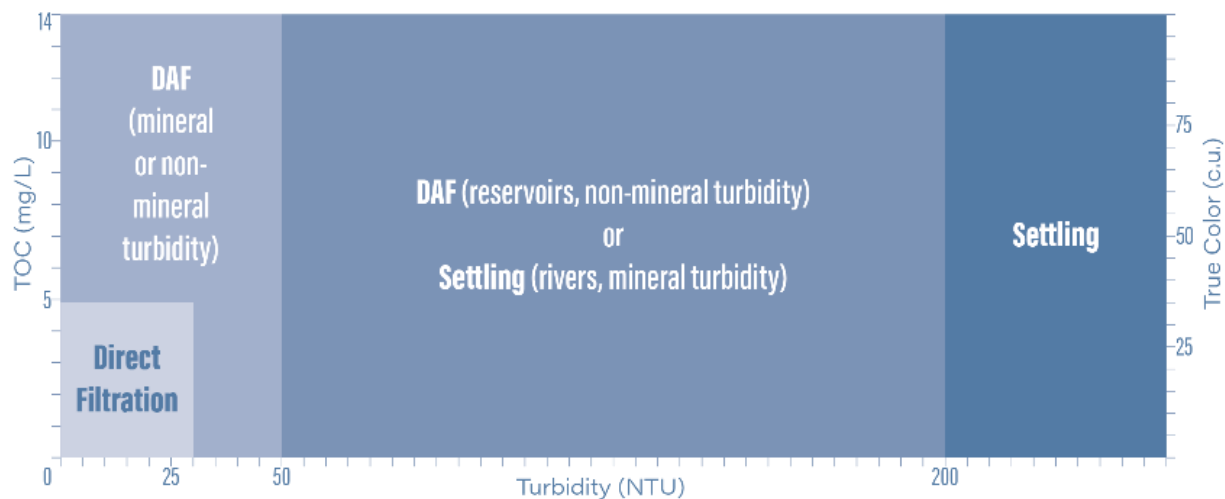

Figure 11-2: Surface Water Treatment Process Selection using Maximum Source Turbidity and TOC (Valade et al. 2009)

We may grant pathogen removal credit of 0.5-log removal for *Giardia lamblia* cysts and 1.0-log removal for viruses (WAC 246-290-660(2) if clarification and sedimentation processes demonstrate consistent and effective pathogen removal and conform with accepted professional standards and guidelines, such as those noted in this section. If such pathogen removal credit is granted, the water system **must** meet the disinfection byproduct precursor removal requirements under 40 CFR 141.135 (WAC 246-290-660(3)).

Ballasted Sedimentation: This high-rate sedimentation process uses polymers and very fine sand to accelerate the sedimentation process. As a result, the detention time in the flocculation and sedimentation process is short, and surface loading rates are high, usually between 8 and 20 gpm/ft². The process very effectively removes high turbidity loads usually associated with river sources. In addition, the process has been shown to consistently and effectively remove *Giardia lamblia* cysts, so it can be granted 0.5 log *Giardia* removal credit if the surface loading rate does not exceed 20 gpm/ft² (AWWA/ASCE 2012a, Alvarez et al. 1999, Kawamura 2000). With the short detention times, a certified operator needs to monitor the process closely to minimize the risk of process upsets that could affect downstream filtration and disinfection processes. Ballasted sedimentation should not be used upstream of membrane filters because the polymers used in the sedimentation process may adversely affect performance of the membrane filters.

Contact Adsorption Clarification: Small package plants use this process on low to moderate turbidity sources. The process functions more like a roughing filter than a gravity sedimentation or flotation process. Coagulated water flows through coarse media about the size of pea gravel. As coagulated water passes through the media, larger flocculated particles develop and attach to the clarifier media. The media is periodically cleaned using an air and water flushing process to remove the solids. For non-buoyant media, prescreening is important to prevent plant debris and other materials from clogging the clarifier. In addition, flow-to-waste piping and controls should be provided to minimize start-up spikes from being passed on to downstream filters.

High turbidity levels and high organic loads requiring significant coagulant addition—such as turbidity greater than 30 NTU and total organic carbon (TOC) greater than 5 mg/L—can quickly clog the clarifier media or cause high levels of DBPs. Where suitable, typical surface loading rates are 8 to 10 gpm/ft² (AWWA/ASCE 2012a). Given the cyclical nature of CAC performance, and limited research demonstrating the effectiveness of contact adsorption clarifiers for removal of pathogenic protozoa and DBP precursors, we cannot currently grant any pathogen removal credit for this clarification process.

Dissolved Air Flotation (DAF): Water systems use this process on lake and reservoir sources, especially those that experience algal blooms or have high concentrations of natural organic matter. The DAF process introduces coagulated and flocculated water into the clarifier where very fine bubbles float flocculated particles to the surface for removal. The process removes clarified water near the bottom of the basin.

DAF can be classified as conventional or high-rate depending on the basin design. In most cases, the clarifiers used for conventional DAF are less than 8 feet deep, have length-to-width ratios of at least 1.0, and have surface loading rates of less than 6 gpm/ft². Conventional DAF has demonstrated significant removal of *Giardia lamblia* cysts, so we can grant 0.5 log *Giardia* removal credit if the surface loading rate does not exceed 6 gpm/ft² (Alvarez et al. 1999, Edzwald et al, 2001; Plummer et al 1995). High-rate DAF is a more recent development. The clarifiers used in this process are deep, up to 16 feet, the length-to-width ratio can be less than 1.0, and loading rates may be as high as 16 gpm/ft². Because there is limited research on the effectiveness of high rate DAF for removal of pathogenic protozoa, we cannot currently grant pathogen removal credit for this clarification process.

Gravity Sedimentation: This process employs tube or plate settlers to allow for greater surface loading rate and improved process performance than open basins. Water systems have used gravity sedimentation on a variety of source waters, though it is best suited for those that experience high turbidity loads. Flocculation is necessary prior to gravity sedimentation to develop a floc that will settle. In general, the surface loading rate above the portion of the basin using tube settlers is limited to less than 2.0 gpm/ft²; and the loading rate for plate settlers is limited to 0.5 gpm/ft² based on 80 percent of the projected horizontal plate area.

Recommended loading rates are even lower if the treatment objectives are to remove color or algae. The process has been shown to provide effective removal of pathogenic protozoa (Logsdon et al. 1985, Haas et al. 2001). Therefore, we can grant the process 0.5-log *Giardia* removal credit if the design follows industry guidelines, such as those in the *Recommended Standards for Water Works*.

11.2.4 Filtration

Water systems **must** filter all surface water sources unless they meet very stringent source water protection, control, monitoring, disinfection, and operational criteria (WAC 246-290-630). Various filtration technologies provide effective pathogen removal and can be used to meet surface water treatment requirements, including:

- Rapid rate filtration
- Diatomaceous earth filtration
- Slow sand filtration
- Membrane filtration
- Bag and cartridge filtration

The most appropriate filtration technology will vary depending on various factors, including source water quality, the availability of skilled operators, land and energy requirements, costs, availability of replacement parts for proprietary technology, and other resource considerations. For example, rapid rate filtration may be well suited a large system with a high turbidity river source, and poorly suited to a cold, clear lake in a remote mountainous region (where a bag filter would be more appropriate). The best choice for a small water system usually is the simplest available technology that can effectively treat the source water quality. Basic information for these filtration technologies is in Table 11-2 and the following summaries.

A well designed, operated, and maintained filter is very effective at removing pathogens and many other contaminants. However, at the start of a filtration cycle the filtered water quality may be less than optimal. For this reason, design engineers **must** provide filter-to-waste capability for all surface water filtration facilities (WAC 246-290-676(4)(b)(iii)).

Table 11-2: Filtration Technologies

Filtration Technology	Prefiltration Chemicals Used	Maximum Filtration Rate (gpm/ft ²)	Pathogen Removal Credit		Operational Complexity
			<i>Giardia</i> <i>Cryptosporidium</i>	Viruses	
Rapid Rate Filtration	Oxidant, coagulant, polymers	6.0 ¹	2.0-log	1.0-log	High
Diatomaceous Earth Filtration	Diatomaceous Earth	1.0 ²	2.0-log	1.0-log	Moderate
Slow Sand Filtration	Usually none	0.1	2.0-log	2.0-log	Low
Bag and Cartridge Filtration	Usually none	See Note 3	Mfr. specific	None	Low
Membrane Filtration	Varies	See Note 3	Mfr. specific	None	Moderate

¹ Maximum filtration rates are lower if single media filter beds are used instead of deep bed, dual or mixed media filters (see WAC 246-290-654).

² DE filtration may be designed for up to 2.0 gpm/ft² if the design engineer demonstrates that filtration at the higher rate consistency achieves at least 99 percent removal of *Giardia* and 99 percent removal of *Cryptosporidium*, and meets the performance requirements of WAC 246-290-660. To maintain the integrity of the DE filter cake, filters should be designed to prevent the filtration rate from dropping below 0.25 gpm/ft².

³ Maximum loading load rates are manufacturer and equipment specific.

Rapid Rate Filtration: This filtration technology involves adding multiple chemicals upstream of granular media filters. Commonly used chemicals include oxidants, coagulants, and various polymers. Typical filter media include anthracite, sand, granular activated carbon, garnet, and ilmenite. Periodically, the filters are backwashed to remove

the particles and pathogens that attach to the filter media. The pretreatment process used prior to filtration can further classify rapid rate filtration:

- **Conventional filtration** process includes coagulation, flocculation, and clarification prior to filtration. The clarification process may be awarded pathogen removal credit.
- **Direct filtration** process provides coagulation and flocculation prior to filtration. It does not include sedimentation or clarification. Some direct filtration plants employ a contact adsorption clarifier (see Section 11.2.3).
- **In-line filtration** process provides only coagulation and rapid mixing prior to filtration. With such limited pretreatment, in-line filtration should only be used to treat sources with low turbidity and low concentrations of natural organic matter.

Numerous other texts and standards cover the design of rapid rate filtration in detail, including:

- AWWA Standard B100: Standard for Granular Filter Media (AWWA 2016a)
- Water Treatment Plant Design: Ch. 9. High-Rate Granular Media Filtration (AWWA/ASCE 2012b)
- Recommended Standards for Water Works. Section 4.3.1 Rapid Rate Gravity Filters (Ten State Standards 2012)
- Integrated Design and Operation of Water Treatment Facilities (Kawamura 2000)

Engineers should review these references and other resources as part of their evaluation of rapid rate filtration for any source.

Diatomaceous Earth (DE) Filtration: For this process, the operator establishes a DE precoat on a mesh screen or fabric, called a septum, before initiating the filtration process. The water system can treat water after about $\frac{1}{8}$ -inch of DE coats the filter septa. During each filter run, the process continuously feeds a small amount of DE to maintain the porosity of the filter cake that accumulates on the septa. Temperature has very little effect on DE filtration. However, a significant particle load will accumulate, causing rapid head loss. For those reasons, DE filtration may be a good choice for clear, cold source waters. However, DE is more mechanically challenging and requires greater operator oversight than some other filtration technologies.

Numerous other texts and standards cover the design of DE filtration in detail, including:

- AWWA Manual M30 Precoat Filtration (AWWA 1999)
- AWWA Standard B101: Standard for Precoat Filter Media (AWWA 2016b)

- Water Treatment Plant Design: Ch. 10. Slow Sand and Diatomaceous Earth Filtration (AWWA/ASCE 2012c)
- Recommended Standards for Water Works. Section 4.3.3 Diatomaceous Earth Filtration, (Ten State Standards 2012)

Slow Sand Filtration: This process filters water through biologically active sand at a maximum rate of 0.1 gpm/ft², which is 10 to 60 times slower than the filtration rate for most rapid rate filters. As a result, slow sand filters require more surface area and space. However, the process is much simpler. Most installations use no chemicals beyond those required for disinfection.

The filter media size used in slow sand filters is smaller than that used in rapid rate filters, and the filtration process can take a long time to ripen when treating cold, low nutrient source waters. Assessing proper ripening of the filter, or developing of an effective *schmutzdecke* on top of the filter, is a key part of the design process. High turbidity, nutrient-rich source waters can cause head loss to rapidly develop leading to short filter runs. Extensive pilot testing is necessary to determine the suitability of available sand, optimal filtration rate, filter run length, necessary ripening duration, and prefiltration requirements.

Appendix H includes additional information about the design of slow sand filtration. The design of slow sand filtration is covered in detail in numerous texts and standards, including:

- Manual of Design for Slow Sand Filtration (Hendricks et al. 1991)
- Slow Sand Filtration (Huisman and Wood 1974)
- Slow Sand Filtration for Community Water Supply: Planning, Design, Construction, Operation and Maintenance (Visscher et al. 1987)
- Water Treatment Plant Design: Ch. 10. Slow Sand and Diatomaceous Earth Filtration (AWWA/ASCE 2012c)
- Recommended Standards for Water Works. Section 4.3.4 Slow Sand Filters (Ten State Standards, 2012)

Membrane Filtration: Low-pressure membrane filtration effectively removes pathogenic protozoa such as *Giardia* and *Cryptosporidium* from source waters. Also called microfiltration and ultrafiltration, the process may use a coagulant to decrease fouling of the membrane, extend the time between cleaning processes, and to remove some of color caused by natural organic matter. Natural organic matter can lead to the undesirable formation of disinfection byproducts and exerts a disinfection demand.

Membrane filtration systems are proprietary, with fiber and module designs differing significantly between manufacturers. For these reasons, pilot testing conducted on one type of membrane is not transferrable to another. As proprietary systems, we grant membranes pathogen removal credit on a case-by-case basis (WAC 2465-290-660(e)). Also, as proprietary equipment, there is some financial risk to the water system if the membrane manufacturer goes out of business or stops manufacturing membrane system components. See [DOH 331-617](#) for a list of currently approved membrane filtration systems.

Numerous other texts and standards cover the design of membrane filtration in detail, including:

- Membrane Filtration Guidance Manual (USEPA 2005)
- AWWA B110: Standard for Membrane Systems (AWWA 2016c)
- AWWA Manual M53 Microfiltration and Ultrafiltration Membranes for Drinking Water (AWWA 2016d)

Bag and Cartridge Filtration: Water systems use these filtration technologies to treat sources with very low turbidity and low color because the filters cannot be backwashed and do not remove any organic matter. To decrease the frequency for replacing filters, most systems have one or more prefiltration steps before the final filter unit. A common approach is to use multiple prefilters in series, such as 50 *um*, 10 *um*, and 5 *um* nominal size cartridge filters, upstream of the compliance filter.

Bag and cartridge filters used for pathogen removal credit are proprietary equipment, similar to membrane filtration systems. As such, we grant them pathogen removal credit on a case-by-case basis (WAC 246-290-660(e)). The pathogen removal credit is specific to a bag and housing combination. Also, as proprietary equipment, there is some financial risk to the water system if the filter system manufacturer goes out of business, stops manufacturing the filters, or otherwise stops supporting the technology. See [DOH 331-616](#) for a list of currently approved bag and cartridge filtration systems.

11.2.5 Disinfection

Disinfection treatment approaches differ depending on the intended purpose of the application. Water systems **must** treat surface water and GWI sources to inactivate protozoa and viruses (WAC 246-290-601(1)). See Section 10.2.1 for general information on preliminary design considerations for disinfection processes.

For surface water and GWI sources, disinfection combined with filtration **must** provide at least 3-log (99.9 percent) removal or inactivation of *Giardia lamblia*, and at least 4-log

(99.99 percent) removal or inactivation of viruses (WAC 246-290-662(1)). Filtration credit for removal of *Giardia lamblia* cysts and viruses establishes the minimum disinfection inactivation requirement. Regardless of the removal credit granted for filtration, water systems **must** provide at least 0.5-log (68 percent) inactivation of *Giardia lamblia* cysts and 2-log (99 percent) inactivation of viruses (WAC 246-290-662(1)(c)) through continuous disinfection. This disinfection process often is called primary disinfection.

Water systems that supply surface water also **must** maintain a disinfection residual throughout the distribution system (WAC 246-290-662(6)). This maintenance of a distribution system residual often is called secondary disinfection.

If ultraviolet disinfection is being considered as a primary disinfectant, the design engineer should review the information in [Policy F.13](#) and Appendix I.

11.2.5.1 Determining Disinfection Efficacy

Multiple factors influence the effectiveness of disinfection. The two main factors under the operator's control are the concentration of the disinfectant (C) and contact time (T), which is proportional to flow. The required CT depends primarily on the water temperature and pH. The ratio of CT_{calc} to $CT_{required}$ is called the inactivation ratio (IR); it should always be more than 1.0, and preferably greater. An IR less than 1.0 on more than one day in a month is a treatment technique violation. To account for unexpected conditions and provide a factor of safety we recommend designing the disinfection process, including process control elements, to provide a minimum IR of 1.2 to 1.5.

The design engineer should clearly identify how the water systems will determine daily CT_{calc} values. At a basic level, Equation 11-1 can define $T_{credited}$ through a structure (clearwell, reservoir, or pipe). Where there are multiple different segments, the CT_{calc} for each segment needs to be monitored, calculated separately, and added together.

Equation 11-1:

$$T_{credited} = BF \left(\frac{V}{Q} \right)$$

Where:

BF = the baffling factor (BF) of the structure, sometimes referred to as T_{10}/T .

V = the volume of water in the structure.

Q = the flowrate of water through the structure.

The baffling factor is the ratio between the time for 10 percent of the water to flow through a structure divided by the mean residence time in the structure. The greater the

degree of baffling, the higher the baffling factor. A baffling factor of no more than 0.1 should be applied to structures with separate inlets and outlets and no internal baffling.

For other structures, engineers can use a conservative estimate based on guidance documents (Crozes et al. 1999). However, do not use the empirical or estimated baffling factors outlined in Surface Water Treatment Rule-related guidance because it poorly defines the baffling factors of poor, average, and superior, and does not reflect typical designs (USEPA 1990; AWWA/ASCE 2012d).

Use caution when evaluating contact basins where the depth is significantly greater than the width. In these cases, significant short-circuiting can occur without proper design of the inlet, outlet, and baffling structures. The results of multiple tracer studies performed at 32 water treatment plants in Washington during 2014–2016 (see Porter et al 2018), provide valuable insight into the design of contact basins and highlight the importance of cross-sectional velocity, especially at low flows in the laminar flow range (Reynolds numbers less than 2,000).

Contact basin design should include provisions for tracer chemical injection and sample taps for tracer monitoring at the influent, after injection and mixing, and directly from the effluent. Sequential basins should include sample locations between each basin.

For pipes, a length-to-diameter ratio of at least 160 is needed to achieve a baffling factor of 1.0 if the flow through the pipe is turbulent and not laminar. For pipe segments with a length-to-diameter ratio of at least 40, a baffling factor of 0.7 can be used (CDPHE 2014). For shorter pipe segments, engineers can estimate the baffling factor by using the length-to-width ratio and information in *Improving Clearwell Design for CT Compliance* (Crozes et al. 1999).

Some other important design considerations:

- **Flow monitoring:** To provide accurate calculations of contact time, you need to monitor the flow leaving each contact chamber. When using parallel clearwells, you should monitor the flow from each. Unequal flow splits can lead to short-circuiting even when using valves and gates to develop an even flow split. (Porter et.al 2018)
- **Level monitoring:** The most robust design does not allow the volume to fluctuate. Engineers can accomplish this by installing a fixed weir at the outlet to the contact basin and by separating distribution storage from the disinfection contact basin. Where such separation and installation of a weir are not possible, the design engineer should specify a minimum level in the contact basin and

provide level-sensing equipment and controls that will permanently maintain this minimum level setting.

- **Water quality parameter monitoring:** The design **must** provide disinfectant residual, pH, and temperature at the outlet for any CT segment (WAC 246-290-664(4)). In addition, the design should provide disinfectant residual monitoring at the inlet to any CT structure to detect abnormally low or high chlorine residual concentrations that could raise public health or consumer concerns.

When construction is complete, we usually require a tracer study to confirm an empirically estimated baffling factor. While simple in theory, there are many complexities and nuances to a well conducted tracer study. For that reason, you **must** submit a tracer study plan to DOH for review and approval before you start the tracer study (WAC 246-290-636(5)). Additional guidance on conducting tracer studies is in Appendix B.4.

11.2.5.2 Disinfection Profiling and Benchmarking

A disinfection profile is a graphical plot of a system's level of *Giardia lamblia* or virus inactivation measured over a one- to three-year period. Disinfection profiles can identify erratic operation of the disinfection process. They also can show when a system is adding more disinfectant than needed, either seasonally or year-round. Adding more disinfectant may increase disinfection byproduct (DBP) formation. A disinfection benchmark is the lowest monthly average pathogen inactivation ratio during the disinfection profile time period. You can use the benchmark to evaluate the result of a change in treatment.

Modifications to treatment plants can cause changes to the disinfection practices and DBP formation. Therefore, community or nontransient noncommunity systems with surface water or GWI sources **must** develop a disinfection profile if they have elevated levels of DBPs. And, we recommend that all surface water systems develop a disinfection profile. In this context, "elevated" means one of the following:

- The annual average TTHM level is 0.064 mg/L or greater.
- The annual average HAA5 level is 0.048 mg/L or greater (40 CFR 141.530 and 141.172).

When water systems required to develop a profile propose any change to their disinfection process, they **must** include the profile and calculated disinfection benchmark in the project report and include an analysis of how the proposed change will affect the current level of disinfection (WAC 246-290-630(4) and (12)). Examples of disinfection changes that trigger this requirement include moving the point of

disinfection, changing the disinfectant(s) used, increasing pH, and altering contact basin geometry, inlet-outlet piping, or baffling conditions.

11.3 Predesign Studies

Predesign studies, including pilot studies as appropriate, are **required** for proposed treatment projects (WAC 246-290-250). See Chapter 10 and Figure 2-3. The goal of the predesign study is to establish the most effective treatment approach, considering life-cycle costs, and produce treated water that meets all regulatory requirements. A predesign study should precede the project report. As such, engineers **must** include information from the predesign study in the project report (WAC 246-290-250).

Predesign study approaches include desktop, bench-scale, and pilot studies. See Section 10.3 for more detail. For surface water projects, engineers often use desktop and bench-scale studies to assess various treatment options before conducting a more thorough and detailed analysis of a treatment approach through a pilot study.

11.3.1 Pilot Studies

Pilot studies attempt to replicate as closely as possible the operating conditions and treatment results expected at full scale. Pilot plants are scaled-down versions of a proposed process, and may be skid or trailer mounted. Engineers use pilot plant testing to ensure treatment is effective, determine final design parameters, and estimate construction and operation costs.

We usually **require** pilot studies for proposed treatment projects (WAC 246-290-250 and WAC 246-290-676(3)). For surface water treatment, the limited situations that may not need a pilot study include:

- Construction of a new water treatment plant that replaces an existing one using essentially identical treatment processes and design criteria.
- Identical treatment processes applied to nearly identical source waters, such as using the same membrane filtration equipment, including pretreatment on withdrawals with practically identical water quality.

Because equipment for proprietary processes is usually so specialized that pilot testing results are unique to a specific equipment design, it is usually impractical to transfer pilot results from one proprietary design to another. For example, low-pressure membrane filtration systems have different fiber sizes, materials, packing densities, and other factors that affect system performance and limit transferability of design criteria to another membrane system.

11.3.2 Pilot Study Duration

Pilot studies should be long enough to demonstrate the effectiveness, stability, and reliability of the proposed treatment system. Pilot testing of surface water treatment **must** capture seasonal changes in water quality, such as fluctuations in source water alkalinity, temperature, pH, color, turbidity, tastes, odors, and organic matter (WAC 246-290-676(3)). The testing should include the period of most challenging water quality for the piloted treatment technology.

The number of samples collected and study duration can vary widely depending on the type of source, amount of historical data, water quality, and the proposed treatment technology (Logsdon et al. 1996; Ford et al. 2001; AWWA 2012e). In some cases, design engineers can use bench-scale testing to determine the initial operational parameters for pilot testing and possibly decrease the duration of the pilot study. See Table 11-3 for guidance on the duration and objectives of pilot studies for a variety of surface water treatment processes.

11.3.3 Pilot Study Plan and Report

Review the section on pilot studies in Chapter 10. Sections 10.3.3 and 10.3.4 discuss recommended scope and content of a pilot study plan and final pilot study report.

11.4 Project Reports

A project report should define the size, scope, and design parameters for a proposed treatment project. For all surface water projects, the design engineer should seek DOH approval of the project report before submitting construction documents. The water system **must** get DOH approval of the project report before modifying or expanding existing treatment facilities and before beginning construction of new treatment facilities (WAC 246-290-110).

Table 11-3
Surface Water Filtration Pilot Study Duration and Objectives

Treatment	Minimum Recommended Duration¹	Typical Objectives	References
Rapid Rate Filtration	6–12 months ²	Coagulant dose(s), polymer dose(s), sufficient alkalinity, sedimentation rate, hydraulic loading rate, backwash parameters, disinfection byproduct (DBP) precursor removal, finished water quality.	Kawamura 2000a; Logsdon et al. 1996
Slow Sand Filtration	12 months	Pretreatment requirements, ripening period, run length, filter loading rate, sand type, finished water quality.	Hendricks et al. 1991
Diatomaceous Earth (DE) Filtration	1–4 months	Pretreatment requirements, precoat rate, filter media grade, screen size, body feed rate, run length, and finished water quality.	AWWA 1999
Bag and Cartridge Filtration	2–6 weeks	Pretreatment requirements, replacement frequency, finished water quality.	USEPA 2003b
Membrane Filtration	4–7 months	Pretreatment requirements, flux rate and stability, back flush parameters, chemical dose(s), cleaning frequency, fiber breakage, DBP precursor removal, finished water quality. To determine which membrane manufacturer is best suited for source water	Freeman et al. 2006; USEPA 2005

Notes:

¹ When providing a range duration, the design engineer should justify anything less than the maximum duration listed.

² Engineers can consider a series of multiple week pilot studies to cover the expected seasonal variation in water quality instead of operating a full-time pilot plant.

The design engineer should await DOH approval of the project report before submitting 100 percent complete construction documents. Project reports for treatment facilities should reference all planning, design, and applicable pilot study reports for the proposed facility. They **must** include:

- Detailed design criteria and calculations.
- Process control information.
- Proposed methods and schedules for start-up, testing, and operating the completed treatment facility.
- Operational complexity and staffing.
- Operator training and certification requirements.
- Reliability.

Because surface water treatment projects are often more complex than other types of projects, multiple DOH staff participate in review. The design engineer should submit at least three copies of the project report to DOH. See Chapter 2 for additional guidance on preparing project reports.

11.4.1 Design Criteria

Design criteria are a key element of the project report. They define the specific treatment objectives, basis for sizing equipment, and operational requirements. As such, project reports **must** include design criteria for all major treatment-facility project elements (WAC 246-290-110(4)(h)). See Section 10.4.1 for additional guidance on project design criteria and calculations and Section 11.2 for basic information on pretreatment, clarification, filtration and disinfection processes.

11.4.2 Process Control: Monitoring, Instrumentation and Alarms

Process control tools, including monitoring, instrumentation, and alarms, help to ensure that treatment processes are safe and reliable. In addition to meeting regulatory monitoring requirements, these tools allow operators to adjust the treatment process and alert staff when a process may not be functioning properly. See Section 10.4.2 for basic design guidance on monitoring, instrumentation, and alarms. For surface water treatment facilities, the water quality monitoring needed depends on the type of treatment process. Table 11-4 summarizes these needs.

Table 11-4
Surface Water Treatment: Water Quality Instrumentation

Treatment Process	Water Quality Instrumentation for Specific Treatment Processes							
	Streaming Current/Zeta Potential	Turbidity	Particle Counts	Differential Pressure Head Loss	pH Analyzers	Temperature	Disinfectant Residual	UV Transmissivity/Absorbance
Clarification - General		R						
Disinfection - Chemical					E	E	E	
Disinfection - Ultraviolet		R						E
Filtration - Bag and Cartridge		E		E				
Filtration - DE		E		E				
Filtration - Membrane	O	E	E ¹	E				O
Filtration - Rapid Rate	E	E	E/R ²	E				O
Filtration - Slow Sand		E		E				

E = Essential, either a regulatory requirement or necessary for process control.

R = Recommended as part of good design practice.

O = Optional. Not typically used, but could be considered for process control.

Notes:

¹A particle counter or laser turbidimeter is required to indirectly assess membrane integrity.

² Most particle counters are useful for assessing particle breakthrough. In some cases, DOH requires particle counters as part of the design approval.

Some special aspects of process control for surface water treatment

- Streaming Current Monitors or Zeta Potential Meters:** Water systems use these types of instruments for coagulation control. For on-line instruments, there should be a 1- to 3-minute lag time between coagulant addition and when the sample reaches the sensor (AWWA 2011).
- Jar Testing:** Jar testing can be a useful tool for operators to evaluate modifications to treatment processes and chemical dosages. The design engineer should provide the initial jar test settings that reflect plant operations as part of the design process. This should include the mixing speed, mixing times, and chemical injection sequences.
- Turbidimeters and Particle Counters:** You should keep sample lines to these online instruments short to keep the delay between sample collection and the instrument to one minute or less. In addition, engineers **must** provide bench-top equipment for turbidimeters so that operators can perform weekly verification checks (WAC 246-290-638(4)). Place turbidimeters in a location that also allows

measurement of turbidity during filter to waste. You can find useful information about setting up these types of instruments in *Monitoring Surface Water Treatment Processes* ([DOH 331-620](#)).

- **Turbidity Data Recording and SCADA for rapid rate filtration plants:** The SCADA computer usually does turbidity data recording. The file from the SCADA is called the “data log.” The data logs in a SCADA system should have the capacity to handle long-term turbidity data storage needs. The SCADA **must** continually monitor turbidity from each individual filter effluent (IFE) and record the data at least every 15 minutes. The SCADA also **must** record turbidity from the combined filter effluent (CFE) every 4 hours, and record the daily maximum value of the continuous CFE measurements each day (WAC 246-290-664(3)).

To support plant operators in achieving turbidity optimization goals, the SCADA should record maximum IFE and CFE values within a 15-minute period or capture data at intervals of 1 minute or less. Water systems **must** store recorded IFE data for at least 3 years and recorded CFE data for at least 5 years (WAC 246-290-480).

The SCADA should create a daily data log in an easily accessible format - such as .csv or .xlsx - including date, time and turbidity value for each continuous reading turbidimeter. Logged turbidity data should be tagged to identify key filter operating conditions such as filter-to-clearwell, filter-to-waste, backwash, and out of service. The data log files should be in a directory easily accessible to the plant operators. The system should include automatic routine backups both onsite and offsite. Data log storage devices should have surge protection to mitigate power failures. The SCADA monitoring system should be programmed to allow operators to create their own trend lines using a flexible turbidity scale and a flexible time scale. It should also allow operators flexibility to create plant-specific control screens showing selected trend lines. Useful trend lines include selected filter IFE turbidity, filter flow rate, and valve open-closed positions for the selected filter in the same view (USEPA 2019).

11.4.3 Start-up and Testing

A well-planned start-up of any treatment process, including initial testing, is important to ensure the treated water is protective of public health and the process is safe and reliable. Treatment facility submittals **must** include proposed methods and schedules for start-up and testing (WAC 246-290-110(4)(h) and 100(4)). See Section 10.4.3 for additional information on start-up and testing and Section 11.6 for guidance on placing a surface water treatment plant into service

11.4.4 Treatment Plant Operations and Staffing

Project reports for treatment facilities **must** address operation of the completed project, including staffing needs (WAC 246-290-110(4)(h)). Even the smallest and simplest surface water treatment plant should have at least two trained and appropriately certified operators so that public health is not placed at risk if an operator becomes ill, needs to attend to family matters, takes leave, or participates in required training and professional development opportunities.

The design engineer and public water system should work together with an experienced certified water treatment plant operator to develop a staffing plan and include it in the project report submitted to DOH for review and approval. In each staffing plan:

- Establish the legal obligation of the water system to remain fully staffed, maintain the treatment plant facilities, and describe the corrective actions upon failure to do either.
- Identify the organization or people responsible for operating the proposed facility, their required qualifications, and their responsibilities in the plant.
- State that the surface water treatment plant will be visited every day of operation including weekends and holidays.
- Prepare a draft [Purification Plant Criteria Worksheet](#) and identify the correct treatment plant classification.
- Describe the training program for new operators.
- Describe the succession planning process for replacing operators who leave or retire.
- Describe back-up staffing if one or more existing operators are unable to perform tasks.
- Evaluate the number of staff required to ensure safe and reliable operations, considering:
 - **Treatment Technology.** Rapid rate filtration is sensitive to changes in raw water quality and dependent on precise chemical feed processes to function effectively. A significant shift in water quality or even a short interruption in chemical feed can cause the filtration process to suddenly perform poorly and place public health at risk. That's why rapid rate plants with limited or no treatment process automation require continuous staffing. This filtration process is more staff intensive, usually requiring significantly more operational oversight than other types of filtration. Monthly operational water treatment report forms for filtration technologies are on the [forms page](#) of our website. It may be useful to review them when assessing staffing needs.

- **Location.** For small plants, especially those in remote locations, it may be difficult to attract and retain highly certified operators. For these locations, simpler technologies less prone to failure are more appropriate than complex treatment processes requiring a higher level of operator certification. In-plant training programs are essential in these areas to ensure new operators are trained, qualified, and readily available.
- **Automation.** A well-trained operator is essential to ensure that the health of consumers is protected. Automation can be useful for improving process control and ensuring smooth operations when treatment plants are unattended, but cannot replace a well-trained professional to oversee operations and take action if an equipment failure or process upset occurs. The design engineer should consult with DOH early in the design process to determine the conditions under which remote monitoring may be appropriate (USEPA 2003a).
- **Water Quality.** Some sources, such as rivers or lakes prone to algae blooms, may experience rapid changes in water quality that can affect treatment processes. Water systems should consider the vulnerability of the source to such changes when assessing staffing needs.
- **Treatment Capacity:** Larger treatment facilities have more equipment and instrumentation than smaller treatment facilities, and need more staffing time just to keep the facility in good working condition. In addition, the consequences of failure for larger treatment facilities are more significant. For these reasons, most treatment plants greater than 10 MGD provide continuous operational oversight (USEPA 2002).
- **Plant or System Layout.** A compact plant or system with centrally located controls will require a much smaller staff than a facility spread over a larger area.

Contact our Operator Certification Program for advice on finding a qualified certified operator or getting an existing operator certified at the required level.

We developed Table 11-5 (below) after reviewing staffing at existing WTPs and other references. You can use it as a general guide in developing staffing plans for proposed facilities (USEPA 2002; Ohio EPA 2016; Florida DOH 2013).

Inadequate staffing presents a public health risk. The values listed in Table 11-5 represent the estimated minimum time that an operator should spend at a treatment plant each day it operates. Additional time will be required for weekly, monthly, and seasonal operation and maintenance activities, for equipment repairs, unscheduled events, and during times of changing water quality. Don't apply the guidance in Table

11-5 to existing facilities. You should base staffing requirements at existing facilities on what is necessary to protect the health of consumers. Staffing decisions should take into account raw water quality, the site-specific capacity and demands of the treatment process, the degree of automation, and the training and experience of its operators.

**Table 11-5
Surface Water Filtration: Estimated Minimum Staffing**

Filtration Process	Estimated Minimum Staffing per Day		
	Maximum Design Rate		
	<2 MGD	2-10 MGD	>10 MGD
Bag and Cartridge Filtration	1 to 2 hours		
DE Filtration	1 to 2 hours	2 to 4 hours	
Membrane Filtration	1 to 2 hours	2 to 6 hours	6 to 10 hours
Rapid Rate Filtration	4 to 8 hours ¹	8 to 12 hours ¹	At all times
Slow Sand Filtration	1 to 2 hours	2 to 4 hour	3 to 6 hours

Note:

¹. If the design doesn't provide the recommended process control noted in Table 11-6 and automatic shutdown, rapid rate WTPs should be continuously staffed when they operate.

11.4.5 Process Reliability

A high degree of reliability is especially important for surface water treatment facilities because a treatment process failure can present an acute health risk. Most surface water treatment plants include some automation, which can improve process reliability. The extent of automation varies depending on the type of treatment process employed.

Automation analysis should identify the response to these reliability and process control issues:

- Source water quality variations. High or sudden increases in turbidity or color, or decreases in alkalinity related to extreme precipitation events, algal blooms, chemical spills in source water, and other factors that could result in risks to public health.
- Chemical feed issues. Loss of chemical feed or overfeed.
- Equipment failures. Malfunctioning valves, pumps, and process control equipment.
- Finished water quality. High turbidity, inadequate disinfection, and other water quality changes that indicate process upsets.
- Waste handling and disposal. Engineers should consider provisions for waste handling so that waste disposal does not impose restrictions on the main treatment process. See Section 10.8 for special considerations if the design includes recycling any of the backwash waste stream.

Table 11-6 provides a basic overview of recommended process control by treatment process. More extensive guidance is in standard professional references.

Table 11-6
Surface Water Treatment: Recommended Process Control

Treatment Process	Recommended Process Control
Disinfection - Chemical	Continuous flow, pH and disinfection residual monitoring with alarms and shutdown conditions clearly identified. If a minimum water level in the clearwell or reservoir is not maintained via a weir, there should be alarms for critical water levels.
Disinfection - Ultraviolet	Continuous monitoring of the parameters used to calculate UV efficacy (flow, UV intensity, and UV absorbance) with alarms and shutdown conditions clearly identified. See Policy F.13 .
Sedimentation/Clarification	Continuous monitoring of turbidity from each basin or clarifier.
Filtration - Bag and Cartridge ¹	Continuous monitoring of turbidity from each filter and the combined filter effluent. Continuous flow and differential pressure measurements.
Filtration – DE ²	Continuous monitoring of turbidity from each filter and the combined filter effluent. Continuous flow and differential pressure measurements. Uninterruptible power supply for recirculation pumps.
Filtration – Membrane ²	Continuous monitoring of turbidity from the combined filter effluent. Daily direct integrity monitoring. Continuous indirect integrity monitoring of each membrane filtration unit. Continuous flow and differential pressure measurements for membrane filtration unit. Flow-paced chemical feed systems if coagulant control is provided.
Filtration - Rapid Rate ²	Continuous monitoring of turbidity from each filter and the combined filter effluent. Flow-paced chemical feed systems and streaming current-adjusted coagulant feed control. Continuous flow and head loss measurements for filter. Filters should automatically backwash if head loss or turbidity set points are reached. Continuous monitoring of clearwell or reservoir levels if used for backwash supply.
Filtration - Slow Sand ¹	Continuous monitoring of turbidity from each filter and combined filter effluent. Continuous monitoring of flow and head loss for each filter.
Backwash Recycle	Continuous monitoring of flow and turbidity for the settled water that is recycled. Continuous monitoring of water level in the settling process with alarms if the tank level gets too low.

Notes:

¹ Recommended monitoring parameters may not be warranted or feasible for all installations.

² If the recommended automation is not provided for these processes, an appropriately certified operator needs to actively monitor the treatment at all times.

Certain process reliability features **must** be included in the design of any new filtration facility (WAC 246-290-678). These reliability features include:

- **Alarms:** Alarms play a critical role in process control, especially when surface water treatment facilities operate without staff present. Therefore, project reports **must** describe proposed alarms and their settings (WAC 246-290-110(h)). Critical alarms include those for coagulation, filtration, and disinfection. See Section 10.4.2 for additional guidance.
- **Standby equipment:** Such as pumps, chemical feed equipment, and mixers to ensure continuous operation and control of coagulation, clarification, filtration, and disinfection processes.
- **Redundant treatment units:** Redundant units include filtration so that treatment can continue when filters are out of service for operational reasons, such as ripening, backwash, or maintenance. In addition, redundant disinfection units are required for sources that meet the criteria to remain unfiltered. See [Policy F.10](#).

A reliable power supply is another important aspect of process reliability. Most treatment plants should have standby generators to maintain operations and life-safety equipment during power outages. It also may be necessary to install uninterruptible power supplies on some critical process components, such as key chemical feed pumps, instrumentation, SCADA systems, and recirculation pumps for DE filtration to avoid significant process upsets.

Reliability guidelines for surface water facilities include those in the “Policy Statement on Automated/Unattended Operation of Surface Water Treatment Plants” in the *Recommended Standards for Water Works* (Ten State Standards 2012). According to this policy statement, in their project reports, engineers should:

- Identify all critical features in the treatment facility that will be monitored electronically. Describe automatic plant shutdown controls with alarms and conditions that would trigger shutdowns. Dual or secondary alarms may be necessary for certain critical functions.
- Provide automated monitoring of all critical functions with major and minor alarm features. Automated plant shutdown for all major alarms. Inability to automatically startup the plants following a major alarm. Built-in control test capability to verify the status of all major and minor alarms.
- Discuss the ability to operate all treatment plant equipment and process functions manually through the control system.
- Outline plans to challenge test each critical component.

Additional information on treatment-process reliability is in other published design references (AWWA/ASCE 2012f; Ten State Standards 2012).

11.5 Operations Program

Without proper operation and maintenance, surface water treatment involves multiple treatment processes that could deliver unsafe water. An Operations Program is an indispensable tool supporting plant operations staff in achieving optimized treatment.

Creating an Operations Program will inform the design and initial plant start-up, establish routine and contingent activities operators must perform, and create the framework for judging facility performance. New operators will rely on the treatment plant Operations Program for support in quickly gaining an understanding of the procedures and decisions necessary to achieve optimized treatment plant performance. The design engineer **must** prepare a detailed Operations Program for a water treatment facility treating a surface water or GWI source (WAC 246-290-654(5)).

The purpose of the Operations Program is to help water system personnel reliably produce optimally filtered water quality. As such, it should identify specific, quantifiable optimization goals. Engineers can use the following to develop treatment optimization goals:

- DOH Treatment Optimization Program
- EPA Composite Correction Program
- AWWA-EPA Partnership for Safe Water
- AWWA Standard G100: Water Treatment Plant Operation and Management

At a minimum, the Operations Program **must** describe:

- Coagulation control procedures (when a coagulant is used).
- Procedures used to determine chemical dosages and feed rates.
- Operations and maintenance for each unit process, including overall goals and specific water quality targets.
- Treatment plant performance monitoring. Monthly operational report forms for each type of filtration technology are available on our website under [surface water forms](#).
- Laboratory procedures.
- Reliability features.
- Data validation procedures.

- Emergency response plans, especially for treatment process failures and watershed emergencies.

The Operations Program should also include:

- An overall schematic of the treatment process.
- Process and instrumentation diagrams for the treatment facility.
- Control loop descriptions.
- Processes for verifying and calibrating instrumentation, such as turbidimeters, particle counters, pH meters, and chlorine residual analyzers.
- Procedures for testing alarms and confirming communications with on-call operators and water system staff.
- Procedures for completing required monthly operations reports.
- Documented circumstances that require a health advisory to customers, who decides to issue a health advisory, and how the water system will provide communication to customers.
- Procedures for other routine or ongoing monitoring not already included in the regulatory monitoring that may be used for process control.

The engineer or water system **must** submit the draft Operations Program for new, expanded, or modified treatment facilities (WAC 246-290-654(5)). Often, not all of the information needed to complete the Operations Program for these facilities is available until after construction starts. Usually a draft Operations Program is submitted for review and comment during construction. This process allows a revised final draft to be available prior to startup along with the *Construction Completion Report*.

When developing the Operations Program, the design engineer should remember that water system staff will need to periodically update and modify it to reflect their current water treatment practices. As such, the water treatment plant operators and managers should be heavily involved in developing the initial Operations Program, and be able to readily update it.

The project report should initially specify applicable operator training requirements, specific training the equipment supplier(s) will provide, and related schedules. The final Operations Program and equipment-specific operations and maintenance manuals should be available during the operator training sessions.

11.6 Placing a Surface Water Treatment Plant into Service

Given the importance of reliable and effective treatment to the protection of public health, a thorough commissioning process is warranted. Before a surface water treatment plant can be placed into service, it **must** be properly tested, inspected, and disinfected (WAC 246-290-120(4)). A licensed engineer **must** complete a *Construction Completion Report Form* ([DOH 331-121](#)) and submit it to DOH before a water system uses treatment facilities to serve water to the public (WAC 246-290-120(5)).

This section complements the more general information about placing a water treatment plant into service in Section 10.9. These more general topics include:

- Prestart-up meetings.
- Start-up of other plant components.
- Testing of process instrumentation.
- Potential for effects on the distribution system (sediment release and corrosion control).

Monthly operational report forms for each type of filtration technology are available on our website under [surface water forms](#). Water system operating staff should review these forms before final commissioning. This will allow operating staff to work with their DOH regional engineer on adapting the forms specific to the treatment facility, integrating them with process control, SCADA, and operational practices. Before the facility begins to serve water to consumers, the operator in responsible charge should plan to submit to DOH a completed set of operational reporting forms that address any reporting issues we raised.

Each set of operational reporting forms for a surface water treatment plant includes one form for disinfection. The process for calculating the CT_{calc} , including determination of volume(s), flow(s), and baffling factor(s), should be established in the project report as outlined in Section 11.2.4. The design engineer should confirm the process for calculating the CT_{calc} prior to commissioning, as the initial design assumptions could have changed in the design process. The operator should plan to submit sample or example disinfection monitoring results to DOH before serving water to the public.

Planning for disposal of treated water is an important part of the start-up due to the large volume of water that may need to be discarded before serving water to customers. To address this issue, it may be necessary to operate the water treatment plant intermittently.

Table 11-7 summarizes the final commissioning tasks that should be completed before serving water to customers. These comprehensive commissioning tasks usually follow thorough testing of individual treatment plant components, as well as disinfection and bacteriological testing. We covered this type of testing in Section 10.9, and in other chapters on individual plant components such as pump testing and treated water storage facilities.

Table 11-7
Surface Water Treatment Technologies: Start-up and Testing

Treatment	Minimum Recommended Duration ¹	Final Commissioning Tasks
All Types of Treatment	NA	Confirm instrumentation and process control work correctly; test alarms. Compare instrumentation output with readings in SCADA. Complete applicable portions of monthly operational reports and submit. Check finished water quality.
Rapid Rate Filtration	5 days	Assess backwash process, settings, and filter-to-waste. Complete at least two filter runs, including backwash and filter-to-waste cycles.
Slow Sand Filtration	3 months	Allow filters to fully ripen. Complete coliform or other biological testing.
Diatomaceous Earth (DE) Filtration	2 days	Complete at least two filter cycles (precoat, body feed, DE removal) to ensure all systems work.
Bag and Cartridge Filtration	8 hours	Confirm that instrumentation works correctly, test alarms (if applicable).
Membrane Filtration	3 days ²	Complete at least 16 hours of operational multiple filtration cycles, test maintenance cleaning process.
UV Disinfection	2 days	See Appendix I

Notes:

¹ The design engineer and water system should justify anything less than the duration listed.

² For membrane systems, there may be initially high particle counts or filtered water turbidity. If these conditions persist, direct integrity testing may be required every 4 hours until the indirect integrity monitoring provides reliable results.

For most surface water treatment facilities, a few tasks usually are completed after the plant is operating fully and serving water to customers. These tasks include:

- **Field Data Sheet:** This document summarizes the processes and operational settings for the treatment plant. Engineers should develop it with the DOH regional engineer, who can provide an appropriate template for the treatment technology being installed.

- **Tracer Study:** Engineers usually need to make some assumptions about the operational levels and baffling efficiency of the disinfection process to calculate the initial CT_{calc} of the disinfection process. Often, they need to conduct a tracer study after constructing the disinfection facilities to confirm or revise the initial hydraulic assumptions. See Appendix B.4.
- **Disinfection Summary:** This document provides the basics for determining the effectiveness of disinfection for a treatment facility, including any underlying assumptions. This document is sometimes called a “CT summary.”
- **Final Operations Program:** As noted in Section 11.5, the engineer or water system **must** submit an Operations Program for new, expanded, or modified treatment facilities (WAC 246-290-654(5)). They should submit a draft Operations Program during facility construction and a final version during or shortly after the commissioning process.

References

- Alvarez, M., J. Nash, and G. Mitskevich 1999. Evaluation of High Rate Treatment Processes for Highly Colored Florida Surface Water Using Particle Counting, AWWA WQTC.
- AWWA. 1999. *Precoat Filtration*, 2nd Edition: AWWA Manual M30. American Water Works Association, Denver, CO.
- AWWA. 2011. *Operational Control of Coagulation and Filtration Processes*, 3rd Edition: AWWA Manual M37. American Water Works Association, Denver, CO.
- AWWA. 2016a. B100 – AWWA Standard for Granular Filter Material. American Water Works Association, Denver, CO.
- AWWA. 2016b. B101 - AWWA Standard for Precoat Filter Media. American Water Works Association, Denver, CO.
- AWWA. 2016c. B110 - AWWA Standard for Membrane Systems. American Water Works Association, Denver, CO.
- AWWA. 2016d. *Microfiltration and Ultrafiltration Membranes for Drinking Water*, 2nd Edition: AWWA Manual M53. American Water Works Association, Denver, CO.
- AWWA and American Society of Civil Engineers (ASCE). 2012. *Water Treatment Plant Design*, 5th Edition, McGraw-Hill. New York, NY.
- , (a) Chapter 8. Clarification
- , (b) Chapter 9. High Rate Granular Media Filtration
- , (c) Chapter 10. Slow Sand and Diatomaceous Earth Filtration
- , (d) Chapter 11. Oxidation and Disinfection
- , (e) Chapter 19. Pilot Plant Design and Construction
- , (f) Chapter 29. Design Reliability Features

- CDPHE. 2014. *Baffling Factor Guidance Manual: Determining Disinfection Capability and Baffling Factors for various Types of Tanks at Small Public Water Systems*. Colorado Department of Public Health and Environment, Denver, CO.
- Cleasby, J. L., Hilmoie, D. J., & Dimitracopoulos, C. J. 1984. Slow sand and direct in-line filtration of a surface water. *Journal AWWA*, Vol. 76. No. 12. pp. 44-55.
- Crozes, G. F., J.P. Hagstrom, M.M. Clark, J. Ducoste, and C. Burns. 1999. *Improving Clearwell Design for CT Compliance*. AWWA Research Foundation, Denver, CO.
- Edzwald, J. K., Tobiasson, J. E., Dunn, H., Kaminski, G., & Galant, P. 2001. Removal and fate of *Cryptosporidium* in dissolved air drinking water treatment plants. *Water Science and Technology*, Vol. 43. No. 8, pp. 51-57.
- Florida. 2013. Florida Administrative Rules Chapter 62-699: Treatment Plant Classification and Staffing. Effective 3/6/2013. Florida Department of Health, Tallahassee, FL.
- Ford, R., M. Carlson and W.D. Bellamy. 2001. "Pilot-testing with the End In Mind," *Journal AWWA*, Vol. 93, No. 5, pp. 67-77.
- Freeman, S., B. Long, S. Veerapaneni, and J. Pressdee. 2006. "Integrating Low-pressure Membranes into Water Treatment Plants," *Journal AWWA*, Vol. 98, Issue 12, pp. 26-30.
- Great Lakes-Upper Mississippi River Board of State and Provincial Public Health and Environmental Managers. 2012. Ten State Standards - *Recommended Standards for Water Works*. Health Education Service, Albany, NY.
- Haas, C., French, K., Finch, G. R., & Guest, R. K. 2001. *Data Review on the Physical/chemical Removal of Cryptosporidium*. AWWA Research Foundation, Denver, CO.
- Hendricks, D., J.M. Barrett, J. Bryck, M.R. Collins, B.A. Janonis, and G.S. Logsdon. 1991. *Manual of Design for Slow Sand Filtration*, Chapter 4: "Pilot Plant Studies," AWWA Research Foundation, Denver, CO.
- Huisman, L., & Wood, W. E. (1974). *Slow Sand Filtration*. World Health Organization. Geneva, Switzerland.

- Kawamura, S. 1999. Design and operation of high-rate filters. *Journal AWWA*, Vol. 91. No. 12, pp. 77-90.
- Kawamura, S. 2000. *Integrated Design and Operation of Water Treatment Facilities*, 2nd Edition, John Wiley & Sons, New York, NY.
- Letterman, R.D. 1986. *The Filtration Requirement in the Safe Drinking Water Act Amendments of 1986*. USEPA/AAAS Report.
- Logsdon, G. S., Thurman, V. C., Frindt, E. S., & Stoecker, J. G. 1985. Evaluating sedimentation and various filter media for removal of Giardia cysts. *Journal AWWA*, Vol. 77. No. 2. pp. 61-66.
- Logsdon, G., S. LaBonde, D. Curley, and R. Kohne. 1996. Pilot-Plant Studies: From Planning to Project Report, *Journal AWWA*, Vol. 88, No. 3, pp. 56-65.
- Mote, P. W., Hamlet, A. F., Clark, M. P., & Lettenmaier, D. P. 2005. Declining mountain snowpack in western North America. *Bulletin of the American Meteorological Society*, Vol. 86. No. 1.
- Ohio EPA. 2016. Ohio Administrative Code (OAC) 3745-7: *Operator Certification for Public Water Systems and Wastewater Treatment Works*. Effective 3/4/2016. Ohio Environmental Protection Agency, Columbus, OH.
- Plummer, J. D., Edzwald, J. K., & Kelley, M. B. (1995). Removing Cryptosporidium by dissolved-air flotation. *Journal AWWA*, Vol. 87. No. 9, pp. 85-95.
- Porter R.L., Stewart K.P., Feagin N., Perry S. Baffling efficiency insights gained from tracer studies at 32 Washington treatment plants. *AWWA Wat Sci*. 2018;e11115.
- USEPA 1975. *Manual for Evaluating Public Drinking Water Supplies: A Manual of Practice*. USEPA 430/9-75-011.
- USEPA. 1990. *Guidance Manual for Compliance with the Filtration and Disinfection Requirements for Public Water Systems Using Surface Water Sources*, EPA Contract No. 68-01-6989.
- USEPA. 2002. *Community Water Systems Survey 2000. Volume II: Detailed Tables and Survey Methodology*. EPA 815-R-02-005B.

- USEPA. 2003a. *Small Drinking Water Systems Handbook – A Guide to “Packaged” Filtration and Disinfection Technologies with Remote Monitoring and Control Tools*. EPA/600/R-03/041
- USEPA. 2003b. *Long Term 2 Enhanced Surface Water Treatment Rule: Toolbox Guidance Manual (Draft)*, Chapter 8: “Bag and Cartridge Filters,” EPA 815-D-03-009.
- USEPA. 2005. *Membrane Filtration Guidance Manual*, EPA 815-R-06-009.
- USEPA. 2019. *Generating High-Quality Turbidity Data in Drinking Water Treatment Plants to Support System Optimization and Monitoring*, EPA 815-B-19-010
- Valade, M. T., Becker, W. C., & Edzwald, J. K. 2009. Treatment selection guidelines for particle and NOM removal. *Journal of Water Supply: Research and Technology-Aqua*, Vol. 58. No. 6, pp. 424-432.
- Vischer, J.T.; Paramasivan. R.; Raman, A.; Keijnen, H.A. 1987. *Slow Sand Filtration for Community Water Supply: Planning, Design, Construction, Operation and Maintenance*. International Reference Centre for Community Water Supply and Sanitation. The Hague, The Netherlands.

Appendix A: Forms, Policies, and Checklists

Appendix A.1 Forms

Appendix A.2 Policies

Appendix A.3 Project Checklists

Appendix A.1 Forms

You can obtain DOH forms for drinking water projects by contacting our regional offices (see Table 1-1). The forms referenced in this manual are at

<http://www.doh.wa.gov/CommunityandEnvironment/DrinkingWater/PublicationsandForms/Forms.aspx>. For persons with disabilities, forms are available on request in other formats. To submit a request, call 800-525-0127 (TTY 1-800-833-6388).

- ✓ **Project Approval Application Form (331-149).** The [Project Approval Application Form](#) identifies the project applicant, design engineer, water system, and type of project. We use this information to determine review and approval fees.
- ✓ **Water Right Self-Assessment Form (331-370 or 331-372).*** The [Water Rights Self-Assessment Form](#) identifies the water right information we need to review and approve construction documents and project reports. We will forward the *Water Right Self-Assessment Form* to the Department of Ecology for review.

Water system plans, small water system management programs, and project reports for projects involving a new or expanding source or increased water system capacity **must** include a completed *Water Right Self-Assessment Form* (WAC 246-290-100(4)(f); -105(4)(e); and -110(4)(e)).
- ✓ **Construction Completion Report Form (331-121, 331-146, or 331-147).*** The [Construction Completion Report](#) documents that the project was constructed according to DOH-approved plans and specifications. This form **must** be completed and submitted to us within 60 days of completion and before use of any new or modified water system facility DOH approved for construction (WAC 246-290-120(5)). The water system **must** have a *Construction Completion Report* on file for all distribution mains and other distribution-related facilities a professional engineer designs, but is not required to submit it to DOH for approval under WAC 246-290-125.

* Form depends on project type.

Appendix A.2 Policies

Department of Health Office of Drinking Water policies are available at www.doh.wa.gov/DWPolicies.

Appendix A.3 Project Checklists

Checklists can help design engineers determine whether they met minimum design requirements. On the following pages, you will find various project submittal checklists you can use to prepare submittals for DOH or third party review.

The purpose of the project checklist is to ensure that you submit a complete and properly organized project to DOH. We may return incomplete submittals; that will result in a delayed project review due to the time required to receive the missing information.

DOH developed a project checklist covering each of the project types listed below:

1. General
2. Groundwater Source of Supply
3. Transmission and Distribution Mains
4. Hydraulic Analysis
5. Reservoirs
6. Booster Pump Stations
7. Pressure Tanks
8. Water Treatment Facilities
9. UV (see Appendix I for project checklist)

Appendix A.3.1 General Project Report Checklist

Include the following information in the project report, as applicable to the project and water system's planning status. See Chapter 2, including the project development flowcharts therein, and WAC 246-290-110 and -120 for further design guidance and requirements.

- The signed and dated stamp of a Washington state-licensed professional engineer. Federal facilities can have a PE from any state, but still must have a PE stamp.
- Narrative discussion that establishes the need for the project. It should include a construction schedule for the recommended alternative, project cost, and method of financing. Also, indicate the relationship of the project to the currently approved water system plan or one in the process of being prepared or updated.
- Alternatives analysis and rationale for selecting the proposed project. It should include an evaluation of life cycle costs, including initial capital costs and on-going operations and maintenance costs.
- Appropriate planning elements: Cite appropriate reference in an approved water system plan, prepare an amended water system plan, or include as part of the project report.
- Capacity analysis if seeking a change in the number of approved service connections. Include rationale and calculations to justify total number of service connections and equivalent residential units (ERUs). The analysis should identify the number of residential, industrial, commercial, and municipal connections the water system now serves. If the water system seeks to increase its approved number of connections through construction of new facilities, document water system plan approval status.
- Water Right Self-Assessment Form* must be completed for new sources and all projects that increase the approved number of connections.
- Hydraulic analysis that demonstrates the ability of the project to supply minimum pressure requirements during peak flows and fire events. The analysis should include a narrative discussion that describes the hydraulic analysis method, explains critical assumptions, and summarizes the effect of the proposed expansion on the existing water system.
- Measures to protect against vandalism.
- Disinfection procedures according to AWWA or APWA/WSDOT standards and a narrative discussion on how the project will be disinfected and tested prior to use.
- Provisions to discharge water to waste including description of how wastewater is disposed, and documentation that procedures are acceptable to the Department of Ecology and local authorities.
- Routine and preventive operations and maintenance tasks and their frequency, and the role of a certified operator in completing them.

Appendix A.3.2 Groundwater Source of Supply Checklist

Address these design elements in source of supply project report and construction document submittals. Refer to Chapter 5, WAC 246-290-130 and -135, and Appendix E for further design guidance and requirements. If the new groundwater source requires treatment, refer to Appendix A.3.8.

The following guidance also applies to sources serving existing, unapproved water systems. If the source is an existing well the project proposes to convert into an “approved” water source, the water system or engineer should inform the DOH engineer about any DOH-requested information that is not available (such as a missing well log).

For new surface water supplies, contact your regional engineer for further guidance. Applicable design references include Chapters 5, 10, and 11, and Appendix A.3.8.

Project Report

- Source of supply analysis that justifies the need for a new or expanded source of supply and the alternative source options evaluated.
- Water right permit or certificate issued by the Department of Ecology plus a completed *Water Right Self-Assessment Form*.
- Copies of legal documents (easements or covenants) for the sanitary control area (WAC 246-290-135). See [DOH 331-453](#) and [DOH 331-048](#).
- Water quality test results for each source, including:
 - Bacteriological/coliform test (bacti/coli)
 - Inorganic chemical and physical analysis (IOC)
 - Volatile organic chemical (VOC) test
 - Radionuclide test (only required for community water systems)
 - Synthetic organic chemical (SOC) tests, unless demonstrated that source can meet DOH's requirements for a monitoring waiver
 - Results of any other tests required due to site-specific concerns
- Assess potential effects of the new source of supply on water quality in the distribution system, especially with respect to corrosion and compliance with the Lead and Copper Rule (WAC 246-290-110(4)(d)).
- Assess adequacy of each reservoir overflow capacity to safely discharge the total possible flow to the reservoir (all sources, booster pump station discharges and flow through PRVs) to ensure the structural integrity of each reservoir in the event of control system failure.
- Well site inspection that DOH or the local health jurisdiction did.

- Susceptibility assessment, wellhead protection area (WHPA) delineation, and contaminant inventory within the WHPA (WAC 246-290-130 and -135). See DOH 331-274-F.
- Update the Wellhead Protection Plan (WHPP). See [DOH 331-018](#) and [331-106](#).
- Well log including unique well identification tag number, surface seal, depth to open interval or top of screened interval, overall depth from well the top of the casing, and elevation of top of casing.
- DOH well pumping test results following procedures in Appendix E.
- Source pump control logic and pump cycle protection. Chapter 9 has pressure tank sizing requirements and Chapter 7 has appropriate pump control levels for reservoirs.
- Alarm conditions.
- Given the triggers for mandatory CT6 and 4-log virus inactivation treatment of groundwater sources (see WAC 246-290-451 and -453, respectively) after being placed into operation, we believe it is advantageous to assess and, given construction cost and other constraints, design and install facilities capable of providing 4-log virus inactivation treatment prior to the first connection at each new groundwater source. Submit such assessment. See Appendix F.1 for hypochlorination submittal outline.
- Report on the evaluation of a potential groundwater under the direct influence of surface water source. See WAC 246-290-135.
- Natural and geotechnical hazards analysis of the well site and well house building.

Construction Documents

- Site piping plans including:
 - Source meter set according to manufacturer's minimum required upstream and downstream pipe configuration.
 - Valves (i.e., isolation, check, well pump control, air/vacuum, pressure relief). Show screen secured on each valve discharge outlet.
 - Sample taps for raw and finished water.
 - Location, size, type and class of pipe.
- Pumping equipment specifications including:
 - Horsepower, GPM, head, pump controls, and alarm system.
 - Specific pump curve being used and operation range of head and flow conditions clearly indicated on pump curve.
 - Narrative discussion of ability of the source and pumping system to supply peak daily water volumes.

- Well construction details, including general design and construction standards, casing specifications, general sealing requirements and material specifications, adequately sized and screened inverted well casing vent constructed to prevent entry of contaminants, and access port for measuring water level. See [Policy M.01](#) for information on pitless units and well caps.
- Map of the site and vicinity drawn to scale, including well location (township, range, and latitude-longitude), pump house, water lines, site topography, sanitary protection area, and location of potential sources of contamination including septic systems, sanitary sewers, buildings, roads, and driveways.
- Well house details including security measures, casing and pump house slab elevations, ventilation, room for future disinfection equipment if and when it's needed (if not currently being designed), and electrical connections allowing the use of emergency power.
- Building equipment and instrument layout demonstrating adequate clearance to safely enter, operate, and maintain all well house components.

Appendix A.3.3 Transmission and Distribution Main Checklist

Address these design elements in your transmission and distribution main project report and construction document submittals or reference this information in an approved water system plan. Refer to Chapter 6 and WAC 246-290-230 for further design guidance and requirements.

Project Report

- Water system sizing analysis documenting availability of adequate source and storage to serve the proposed service area.
- Hydraulic analysis used to size mains and to confirm ability to maintain required pressures (see Checklist A.3.4 Hydraulic Analysis for additional details).
- Hydraulic transient analysis for transmission mains and distribution mains where warranted by high pressures or high velocities (see Checklist A.3.4 Hydraulic Analysis for additional details).
- Identification and description of proposed land use within the area the new distribution system will serve.
- Service area map identifying the properties the new distribution system will serve.
- Review of soils in the proposed construction area. Assess corrosivity of soils along the proposed pipe alignment. A qualified professional may need to do a more detailed geotechnical analysis in areas prone to landslides, liquefaction in an earthquake, or other geologic hazards.
- Assess water quality effects associated with physically disturbing existing pipe tuberculation resulting from increased flow velocity and/or reversal of traditional flow direction (see Section 6.2.9).
- Distribution system map showing location of proposed water lines, pipe sizes, pipe material, pressure zone boundaries and hydraulic grade line elevation, easements, and location of control valves, hydrants, meters, and blow-off valves.
- Identification of cross connections and measures designed to eliminate or control such connections.

Construction Documents

- Specifications for:
 - Pipe materials,
 - Disinfection,
 - Bacteriological testing,
 - Pressure and leakage testing.

- Adequate separation from sewer mains, nonpotable conveyance systems, and other buried utilities.
- Construction drawings including:
 - Plan views with a scale of no more than 100-feet to the inch.
 - Easement locations and dimensions, if applicable.
 - Profiles or crossing details with a vertical scale of no more than 10-feet to the inch for:
 - Areas where pipeline projects encounter other utilities that cannot be easily relocated or that could conflict with the proposed pipeline, such as storm and sanitary sewers, gas mains, and telecommunications lines.
 - Pipelines proposed across a streambed.
 - Location, size, and construction materials of all proposed pipelines in the project area. Show all hydrants, valves, vaults, sample stations, meters, blow-off valves, and other distribution system features.
 - Typical construction details of:
 - All new pipeline tie-ins to existing pipelines.
 - Pipeline trench cross-section indicating bedding, backfill, and compaction requirements.
 - Installations of air and vacuum relief valves and vaults, pressure-reducing valves and vaults, backflow assemblies, fire hydrants, blow-offs, sampling stations, and other system appurtenances.
 - Thrust blocking or restraints.
 - Service connection details, where appropriate.
 - Corrosion mitigation measures, where appropriate.
 - All other buried utilities, including storm and sanitary sewers, dry wells, telephone, natural gas, power and TV cable lines in the project area (existing or proposed concurrent with pipeline construction) to the extent possible, given existing available records.
 - Construction drawings should note that all buried utilities are to be field located prior to construction. Notification of the One Call Center/811 is **required** at least two days before any excavation (RCW 19.122).

Appendix A.3.4 Hydraulic Analysis Checklist

A hydraulic analysis **must** be used to size and evaluate new, or expanding to existing, distribution systems. Refer to Chapter 6 and WAC 246-290-230 for additional design considerations. Address these design elements in a hydraulic analysis:

- Description of model whether steady state or extended period simulation.
- Describe assumptions, including:
 - Allocation of demands.
 - Friction coefficients, which will vary with pipe materials and age.
 - Pipe network skeletonization, as appropriate.
 - Operating conditions (source, storage booster pumps, and valves).
- Minimum design criteria are met, including:
 - Peak hourly demand: 30 psi or greater when equalizing storage has been depleted (Section 6.2.5).
 - Maximum day demand plus fire flow: 20 psi or greater when equalizing storage and fire flow storage have been depleted (Section 6.2.5).
 - Transmission main pressure 5 psi or more, except adjacent to storage reservoirs (Section 6.2.2).
 - Maximum pipe velocity: 10 ft./sec or less in transmission mains and 8 ft./sec or less in distribution mains (Section 6.2.6). If not, include hydraulic transient analysis.
- Describe demand scenarios, including:
 - Current demand.
 - Projected 6–10 year demand.
 - Projected build-out demand (for small water systems).
- Water age analysis and, where applicable, updating disinfection byproducts monitoring plan and coliform monitoring plan.
- Provide copies of input and output, including:
 - Input data, (demands, elevations, friction losses, and pump curves).
 - Hydraulic profile.
 - Node diagram.
- Model calibration results satisfy one of the industry criteria for hydraulic models (see Section 6.1.3 and Table 6-1).
- Summary of results, deficiencies and conclusions including:
 - Identification of deficiencies addressed in a capital improvement plan.
 - Locations in distribution system where pressures exceed 80 psi (Section 6.2.7).
 - Hydrant flow and placement on undersized mains.

- Fire flow reliability, if applicable. The Water System Coordination Act (chapter 70.116 RCW) requires water systems that serve more than 1,000 connections or that are located in a critical water supply service area to meet certain reliability standards when pumping provides fire flow (see WAC 246-293-660).

Appendix A.3.5 Reservoir Checklist

Address these design elements in reservoir project report and construction document submittals. Refer to Chapter 7 and WAC 246-290-235 for further guidance and requirements.

Project Report

- Reservoir purpose and sizing analysis including, at a minimum, operating, equalizing, standby, and fire suppression storage requirements. Include documentation of nesting standby and fire suppression storage, if applicable. Adequate tank freeboard also required.
- Reference to applicable industry design standards (e.g., AWWA D-100).
- Reference to and confirmation that applicable OSHA and WISHA safety requirements are satisfied.
- Site feasibility considerations:
 - Location and site considerations (see Section 7.3)
 - Natural hazards analysis (see Section 7.3.1)
- Basis for overflow, bottom of equalizing storage, and bottom of standby or fire-suppression storage elevations including justification by hydraulic analysis.
- Assess capacity of the reservoir overflow to safely discharge the total possible flow to the reservoir (all sources, booster pump station discharges and flow through PRVs) to ensure the structural integrity of the proposed reservoir during a control system failure.
- Basis for overflow and reservoir vent design capacity.
- Describe the level control system and identify specific control levels; SCADA interface.
- If you intend the new reservoir to support aeration or disinfection contact time, refer to Chapter 10 (Treatment).
- Mixing, water circulation, and water age analysis if nominal residence time exceeds 3 to 5 days during the summer.
 - Measures needed to maintain water circulation and prevent water stagnation (dead zones)

Construction Documents (or shop drawings if the contract is so structured)

- Construction details including but not limited to:
 - Reservoir isolation valve(s), which permit isolating the tank from the water system (WAC 246-290-235).
 - Altitude valve and valve vault, if applicable.

- Combination air release and vacuum relief valve on the distribution system side of the isolation valve if there is no other atmospheric reservoir in the pressure zone to prevent vacuum conditions in the distribution system.
 - Smooth-nosed sample tap on the tank outlet pipe, located between the tank and outlet pipe isolation valve (WAC 246-290-235).
 - The capacity to measure water quality at various depths within the reservoir (see Section 7.6)
 - Drain pipe outlet (WAC 246-290-235) (see Section 7.4.3).
 - Overflow pipe inlet and outlet details (including outlet screen, flapper, or duckbill valve protection) (WAC 246-290-235) (see Section 7.4.4).
 - Overflow and drain discharge disposal, drainage pathway, and easement.
 - Inlet, outlet, overflow, and drain piping size, material, location, invert elevations, pipe joints, and couplings below the reservoir and within 20 feet of the reservoir foundation.
 - Tank atmospheric vent, vacuum relief, and screening material (WAC 246-290-235) (see Section 7.4.5).
 - Weatherproof, raised, lockable access roof hatch (WAC 246-290-235) (see Section 7.4.6).
 - Access ways and ladders providing ready, safe access for maintenance (WAC 246-290-235).
 - Security features to protect stored water from contamination due to unauthorized entry or vandalism (see Section 7.4.8).
 - High- and low-level alarm system that directly notifies operations personnel.
 - Location of level control system and details of any wall or roof penetration.
 - Lightning arresters and electrical grounding, as applicable.
 - Silt-stop on the outlet pipe to keep sediment from entering the distribution system.
 - Construction joint details (for concrete reservoirs).
 - Cathodic protection details (for steel reservoirs).
 - Slope of reservoir roof at least 2 percent (1/4 inch per foot) (see Section 7.4.7).
 - Natural hazard design elements such as seismic bracing.
- ANSI/NSF Standard 61 certification of coatings, concrete form release and curing agents, liners, or other materials, if any, that would be in substantial contact with potable water. Application procedures for coatings should be specified in plans and specifications (WAC 246-290-220). See Appendix G for more information.

- Leakage testing procedures per AWWA and a narrative discussion of how the tank will be tested for leaks.
- Disinfection procedures per AWWA and related bacteriological sampling conducted before use (WAC 246-290-451).
- Procedures, if any, to test for taste and odor compounds before use. To confirm the applied coating system cured properly, a VOC sample taken from the filled but not yet commissioned reservoir may be specified.

In addition to applicable elements from the list above, address these design elements in plastic reservoir construction documents (or shop drawings if the contract is so structured):

- Install the tank inside a secured (locked) building because these tanks are vulnerable to vandalism, damage from tree fall, freezing, and UV exposure when located outdoors. If installed outside a building address all physical security risks to the tank.
- Provide headspace and structural support above or beside the tank to enable inspection and safe entry to the tank.
- Put a secondary cover over the screw-in disc hatch to keep dust, rodent droppings, and other potential contaminants off the hatch cover and screw-in frame. If installed outside a building, provide a weatherproof, raised, lockable access roof hatch (WAC 246-290-235) (see Section 7.4.6).
- A reservoir roof vent installed independent of the access hatch.
- Identify all intended modifications (post-delivery) of a plastic tank and provide written approval from the tank manufacturer of the intended modification(s).

Appendix A.3.6 Booster Pump Station Checklist

Address these design elements in booster pump station project report and construction document submittals. Refer to Chapter 8 and WAC 246-290-230 for further guidance and requirements.

Project Report

- Sizing analysis, including pumping system discharge capacity requirements, and fire-flow requirements, if any.
- Flow and pressure control.
- Alarm conditions.
- Hydraulic analysis that demonstrates the ability of the project to meet minimum pressure requirements during peak hourly demands and maximum day demands plus fire flow. The analysis should include a narrative description of the hydraulic analysis method, explain critical assumptions, and summarize the effect of the proposed demands on the existing system (see Checklist A. 3.4 Hydraulic Analysis for details).
- Service area map for the zone(s) to be served.
- Site feasibility considerations:
 - Location and site considerations (see Section 8.2).
 - Natural hazards analysis (see Section 8.2.1).
 - Noise from the pumps and equipment, and any need for noise mitigation.
- Assess capacity of each reservoir overflow to safely discharge the total possible flow to the reservoir (all sources, booster pump station discharges and flow through PRVs) to ensure the structural integrity of each reservoir in the event of control system failure.
- Assess potential for damaging transient pressure wave during pump start up and abrupt pump station shutdown.
- Electrical power issues including:
 - Supply: voltage, quality, and desired phase configuration.
 - Reliability: frequency of power outages.
 - Assessing the need for backup power.

Construction Documents

- Map of the site and vicinity drawn to scale, including the pump station structure, water lines, site topography, roadways, and all above and underground utilities.

- Pump station details including security measures, slab elevation, ventilation, and electrical connections allowing the use of emergency power.
- Building equipment and instrument layout demonstrating adequate clearance to safely enter, operate, and maintain all pump station components.
- Pumping equipment specifications including:
 - Horsepower, flow rate (gpm), head, pump controls, and alarm system.
 - The specific pump curve used and operation range of head and flow conditions.
- Flow and pressure control and instrumentation specifications.
- Site piping plans including:
 - Sample tap(s).
 - Isolation valves on the suction and discharge sides.
 - Flexible couplings.
 - Check valves on the discharge side.
 - Surge anticipation valves, as needed.
 - Suction side pressure gauge(s).
- Pump station start-up task including:
 - Field-testing pumps for output, efficiency and vibration.
 - Disinfecting piping.
 - Pressure, leakage, and bacteriological testing.
- General facility considerations including:
 - Security measures.
 - Special anchoring or support requirements for equipment and piping.
 - Heating, cooling and humidity control for equipment protection and operator comfort.

Appendix A.3.7 Pressure Tank Checklist

Address these design elements in pressure tank project report and construction document submittals. Refer to Chapter 9 (Pressure Tanks), Appendix B.2 (Cycle Control Valves), and Appendix B.3 (Variable Frequency Drives) for further design guidance.

Project Report

- Sizing analysis, pump protection, and pump discharge control.
- Pressure settings. Include a narrative justification of water system hydraulics and operating pressure range.

Construction Documents

- Pressure relief valves:
 - Specify an ASME Section VIII pressure-relief valve installed between a pressure tank greater than 37.5 gallons gross volume and the tank isolation valve.
 - Specify a properly sized pressure relief valve manufactured according to a recognized national standard installed between a pressure tank equal to or smaller than 37.5 gallons gross volume and the tank isolation valve.
 - Pressure relief valve capacity.
 - See [DOH 331-429](#)
- Isolation valve for each pressure tank.
- Site piping plans including location, size, type, and class of pipe.
- Clearance provided around each tank adequate for operations and maintenance.
- Bladder tanks only:
 - Pre-charged pressure
- Hydropneumatic tanks only:
 - Confirmation of oil-less or food-grade oil lubricated air compressor.
 - Air filter.
 - Access hatch with minimum 5-foot clearance.
 - Level control.
 - Sight glass.
 - Structural support and earthquake resiliency or bracing.

Appendix A.3.8 Water Treatment Facilities Checklist

Address these design elements in water treatment project report and construction document submittals. Refer to Chapter 2, including the project development flowcharts therein; Chapters 10 and 11; chapter 246-290 WAC Parts 3 and 6; DOH subject-specific [publications](#); and the project-specific guidance located in these appendices for further guidance and applicable requirements

- Hypochlorination in Appendix F.1
- Sodium fluoride saturators in Appendix F.2
- Arsenic removal in Appendix F.3 and F.4
- Ozone in Appendix F.5
- Desalination of seawater or brackish water in Appendix F.6
- Rainfall catchment in Appendix F.7 and F.8
- Iron and manganese treatment in Appendix F.9 and F.10
- Nitrate removal by ion exchange in Appendix F.11
- Slow sand filtration in Appendix H
- Tracer studies in Appendix B.4

Before any significant design work begins, the engineer should contact the appropriate DOH regional engineer. Please contact one of our [regional offices](#) for guidance on required pilot studies.

Project Report

- Narrative description of water quality problem and type of treatment proposed.
- Analysis of alternatives
 - Raw water quantity and quality.
 - Secondary effects of water treatment. Assess how the proposed project could affect water quality in the distribution system (WAC 246-290-110(4)(d)), and specifically address how a change in treatment will affect compliance with the Lead and Copper Rule (40 CFR 141.86(d)(4)(vii)).
 - Distribution system water quality effects.
 - Operations and maintenance plan, including operator certification requirements, monitoring and reporting requirements, alarm conditions, and daily-weekly-monthly tasks required to achieve reliable operation and treatment performance goals.
 - Waste disposal.
 - Life cycle cost analysis.

- Plant location and site considerations.
- Natural hazards analysis.
- Predesign study.
 - Pilot study plan.
 - Pilot study report.
- Assessment of treatment process reliability
- Detailed design criteria and calculations for:
 - Proposed treatment process.
 - Process control.
- Power reliability.
- Operator and plant safety considerations.
- Performance standards for water treatment facility based on desired water quality at the defined point of compliance.

Construction Documents

- Map of the site and vicinity drawn to scale, including the treatment plant building(s), water lines, site topography, roadways, and all above and underground utilities.
- Treatment plant details, including security measures, slab elevation, heating, cooling and ventilation, and provision allowing the use of emergency power.
- Building equipment and instrument layout demonstrating adequate clearance to enter, operate, and maintain all treatment plant components safely.
- Equipment specifications.
- Flow and pressure control and instrumentation specifications.
- Site piping and instrumentation plans, including:
 - Sample tap(s).
 - Isolation, check, flow control, backflow, and pressure valves.
 - Pressure, flow, level, temperature, and on-line water quality (e.g., pH, turbidity, conductivity, chlorine residual).
 - Alarm conditions.
- Start-up tasks, including:
 - Field-testing equipment to satisfy specifications, including sequence and duration.
 - Disinfection.
 - Pressure, leakage, and bacteriological testing.

- General facility considerations, including:
 - Security measures.
 - Special anchoring or support requirements for equipment and piping.
 - Heating, cooling and humidity control for equipment protection and operator comfort.
- Specifications for materials and equipment for the treatment facility.
- ANSI/NSF Standard 60 certification within approved application dosage of any additives used in the treatment process.
- ANSI/NSF Standard 61 certification of coatings, liners, or other materials, if any, that would be in substantial contact with potable water. Specify application procedures in the plans and specifications.
- Methods and schedules for start-up and performance or acceptance testing of the completed treatment facility.
- Provisions to dispose of solid waste material from the treatment process. Describe how waste is to be properly disposed, and include documentation showing the procedures are acceptable to the Department of Ecology and local authorities.

When the source is surface water, or confirmed to be groundwater under the direct influence of surface water, submittals **must** meet the following additional requirements:

- Disinfection analysis, such as a tracer study (see Appendix B.4), to determine that adequate disinfection can be provided.
- Filter design details including the filter-loading rate and backwash design.
- Turbidimeter locations, including those for individual filter turbidimeters and a combined filter effluent turbidimeter prior to the clearwell.
- Filter-to-waste design including an adequate air gap and properly sized waste pipe.
- Alarms for critical process control elements, such as water levels, coagulation, filtration, and disinfection. Alarms must be set to provide sufficient warning to allow operators to take action or shut the plant down as appropriate.
- Standby equipment for critical processes, such as coagulation, filtration, and disinfection to ensure that the plant can operate continuously.
- Multiple filtration units to allow for major maintenance and repairs on the filtration units. Complete redundancy for peak design flows is not required.
- Draft Operations Program (O&M manual) outlining how the treatment facility will operate. The final manual must describe:
 - Coagulation control methods.
 - Chemical dosing procedure.

- Each unit process and how it will operate.
- Maintenance programs for each unit process.
- Treatment plant performance monitoring.
- Laboratory procedures.
- Recordkeeping.
- Reliability features.
- Emergency response plans, including ones for treatment process failures and watershed emergencies.

Appendix B: Selected Guidelines

Appendix B.1 Well Field Designation and Source Sampling Guidelines

Appendix B.2 Cycle Control Valve Guidelines

Appendix B.3 Variable Frequency Drive Pumps and Motors

Appendix B.4 Tracer Study Checklist

Appendix B.1 Well Field Designation and Source Sampling Guidelines

We support the concept of designating nearby wells that draw from the same aquifer as a “well field.” A well field designation allows the wells of a well field to be monitored as a single source. This designation reduces the number of samples needed to meet water quality monitoring requirements, which reduces monitoring costs for water systems and still protects public health.

This guidance is meant to ensure consistency when dealing with well field designations for Washington state water systems. A design engineer seeking designation of two or more individual wells as a well field should demonstrate all of the following criteria are met:

1. The depth to first open interval of all individual wells are within 20 percent of each other after accounting for wellhead elevation differences.
2. All individual wells draw from the same aquifer(s) as determined by both the following:
 - a. An analysis of water chemistry of all sources that demonstrates similar water chemistry for all analytes.
 - b. An evaluation of geology as documented in well logs or water well reports for all of the wells under consideration.

And, one of the following:

- i. A demonstration that the cones of depression of the wells in the well field overlap under normal operating conditions (e.g. that the water level(s) in the adjacent well(s) in the well field drop when the proposed well of the well field is pumping).
 - ii. A report submitted by a Washington state-licensed hydrogeologist that demonstrates a well field designation is appropriate. If we disagree with the conclusions of this report, we may deny the well field designation.
3. All individual wells:
 - a. Have a sample tap, installed upstream of treatment, that is not influenced by any other well in the well field.
 - b. Discharge to a common pipe, treatment system or storage facility that has a sampling tap located downstream on the common pipe or after the treatment or storage facility but prior to any service connections.
 - c. Be under the control of the same water system.

Notes on monitoring for well fields

To comply with source water quality monitoring requirements from a well field, samples:

1. Should be collected from the sample tap mentioned in requirement 3 above (before the entry point to the distribution system).
2. Should represent normal operating conditions of the well field when the sample is collected That is, not every well in a well field needs to be pumping at the time of sample collection.
3. May **not** be composited with other samples.

Well Field Examples

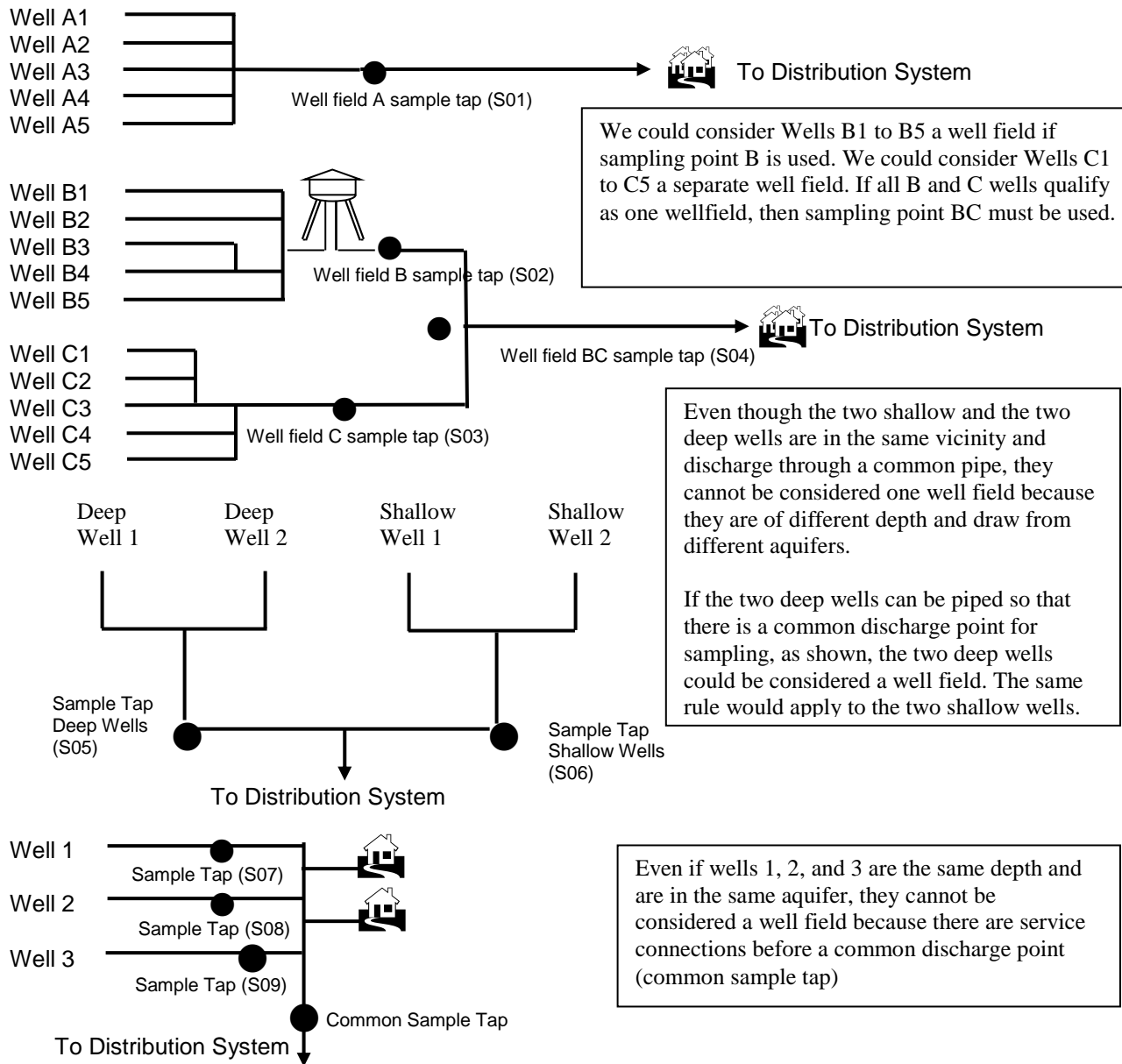

Composite Sampling

DOH Source Code	PWS Source Number	Composite Sampling Allowed?
S01	Well Field A	No. Cannot be composited with other sources
S02 and S03	Well Field B and Well Field C	
S04	Well Field BC	
S05	Well Field Deep Wells	
S06	Well Field Shallow Wells	
S07	Well 1	Yes. Can be composited together for VOC and SOC monitoring compliance
S08	Well 2	
S09	Well 3	

Appendix B.2 Pump Cycle Control Valve Guidelines

Designers may use a pump cycle control valve (CCV) to control distribution system pressure. The CCV is intended to extend run time with minimal pressurized storage. It will maintain constant downstream pressure (the valve's set point) until demand downstream of the valve falls below the valve's prescribed low flow level. At that point, pressure rises to the pressure switch pump-off set point. The valve is mechanically prevented from restricting flow past its preset minimum.

The CCV needs pressurized storage to supply the distribution system when demand falls below the valve's minimum flow setting and shuts down pump operation. The size of the pressure tank(s) will depend on several factors described below, but the size and number always will be less than that required without a cycle control valve. Designers should review manufacturer's recommendations to ensure all valve application requirements are met.

Advantages of using a CCV:

1. Limits well pump on-off cycling and the associated wear on water system components.
2. Reduces the size or number of pressure tanks required for any given installation.
3. Reduces the potential for damaging transient pressure waves ("water hammer") resulting from hard pump-start and pump-stop conditions.

Design considerations and challenges of using a CCV include:

- The control valve can impose significant energy loss ("head loss") at the high end of its flow range when fully open (a 1¼-inch control valve causes the loss of about 10 psi at 50 gpm). The well pump design must account for the head loss the control valve imposes.
- It is difficult to predict whether the savings through limiting the number of "pump-start" events and reduced initial capital cost associated with fewer bladder tanks will offset the cost of the additional energy used to prolong the pump-on portion of the cycle.
- Water quality may affect control valve performance. Particulate matter (sand) may adversely affect the performance of the control valve.
- At low flow conditions, the pressure on the upstream side of the control valve will be near the pump's shut-off head. You should pay attention to the design, material specifications, and construction of the pump to ensure it can operate near its shut-off head for extended periods, and to the pressure rating of the piping and valves on the upstream side of the control valve.

- CCV consumes greater amounts of energy per gallon pumped due to prolonged operation at low pump efficiency.

The CCV is usually installed between the pump(s) and the pressure tank(s). The valve's downstream pressure setting should fall between the pressure switch on and off pressure settings. As demand in the water system varies, the cycle control valve modulates the size of the valve opening to adjust the pressure generated by the pump. The pump-on phase of the pump cycle will continue until water system demand drops below the valve's minimum flow setting. At this point, pump supply in excess of system demand goes into pressurized storage until the pressure tank reaches the pressure switch "pump-off" setting. If demand (including leaks) never drops below the valve's minimum flow setting, the pump will never shut off.

While the pump is off, water released from the pressure tank(s) satisfies all water demand. The length of the "pump-off" period depends on water system demand and the available withdrawal volume of the pressure tank(s).

The number of pump starts per hour is important because excessive heat build-up from too-frequent starts may damage pump motors. With no other recommendation from the pump motor manufacturer, pump starts should be limited to no more than 6 per hour.

To design the pressure tank system to limit pump starts to no more than 6 starts per hour (or per the manufacturer's specification), designers should consider:

- The valve's minimum flow setting and preset downstream pressure setting.
- Pump-on and pump-off pressure setting.
- Where the valve pressure set point falls within the pump-on-off pressure range.

Example

Given:

- Bladder tank system
- Pump on pressure = 40 psi
- Pump off pressure = 60 psi
- Cycling control valve pressure setting = 50 psi
- Pump control valve low-flow setting = 5 gpm

Find:

Volume ("V") of pressurized storage between 60 and 40 psi available to the distribution system while the pump is off to provide for a minimum pump cycle time of 10 minutes (equal to 6 cycles per hour)

Solution:

- The shortest pressure tank fill time + tank draw time occurs when distribution system demand is about equal to one-half the low-flow valve setting (2.5 gpm in this example). System demand is "Y" and valve flow setting is "X".
- To simplify and remain conservative, assume the time to fill the pressure tank from the low-pressure pump-on setting (40 psi in this example) to valve preset pressure setting (50 psi) is instantaneous. Also, assume pressurized volume from 40 psi to 50 psi is equal to the pressurized volume from 50 psi to 60 psi.
- Time to fill (T_f) pressure tank from 50 psi to 60 psi:

$$T_f = \frac{0.5V}{X - Y}$$

- Time to draw down (T_d) pressure tank from 60 psi to 40 psi while pump is off:

$$T_d = \frac{V}{Y}$$

- Solve this equation:

$$\frac{0.5V}{X - Y} + \frac{V}{Y} = 10 \text{ minutes} = 6 \text{ cycles per hour}$$

If X = 5 gpm and Y = 2.5 gpm, then V = 16.7 gallons

In the above example, the bladder tank system must provide at least 16.7 gallons of storage between 40 psi and 60 psi. Based on the following pressure tank manufacturer's information, the drawdown for a nominal 34-gallon pressure tank is 9.1 gallons from 40-60 psi. To provide 16.7 gallons, two 34-gallon pressure tanks are needed. Alternately, one 62-gallon pressure tank will satisfy the pressurized storage requirement.

IN-LINE MODELS

MODEL NUMBER	CAPACITY GALLONS	DRAWDOWN/GALLONS			HEIGHT INCH	DIAMETER INCH	SYSTEM CONNECTION	ASSEMBLY WEIGHT LBS.
		20-40 PSI	30-50 PSI	40-60 PSI				
WX-101	2.0	0.7	0.6	0.5	12-5/8	8	3/4" NPTM	5
WX-102	4.4	1.6	1.4	1.2	15	11	3/4" NPTM	9
WX-103	8.6	3.1	2.7	2.2	25	11	3/4" NPTM	15

STAND MODELS

MODEL NUMBER	CAPACITY GALLONS	DRAWDOWN/GALLONS			HEIGHT INCH	DIAMETER INCH	SYSTEM CONNECTION	ASSEMBLY WEIGHT LBS.
		20-40 PSI	30-50 PSI	40-60 PSI				
WW-20	20.0	7.3	6.2	5.3	31-5/8	15 3/8	1" NPTF	35
WW-32	32.0	-	9.9	8.5	46-3/8	15 3/8	1" NPTF	43
WX-201	14.0	5.1	4.3	3.7	23-7/8	15 3/8	1" NPTF	27
WX-202	20.0	7.3	6.2	5.4	31-5/8	15 3/8	1" NPTF	35
WX-203	32.0	-	9.9	8.6	46-3/8	15 3/8	1" NPTF	43
WX-205	34.0	12.4	10.5	9.1	29-1/2	22	1-1/4" NPTF	61
WX-250	44.0	16.3	13.6	11.9	35-5/8	22	1-1/4" NPTF	69
WX-251	62.0	22.9	19.2	16.7	46-3/4	22	1-1/4" NPTF	92
WX-252	86.0	34.6	29.2	24.9	62-1/4	22	1-1/4" NPTF	114
WX-255	81.0	34.6	29.2	24.9	56-13/16	22	1-1/4" NPTF	114
WX-302	86.0	34.6	29.2	24.9	46-13/16	26	1-1/4" NPTF	123
WX-350	119.0	44.0	36.9	32.1	61-7/8	26	1-1/4" NPTF	166

UNDERGROUND MODELS

MODEL NUMBER	CAPACITY GALLONS	DRAWDOWN/GALLONS			HEIGHT INCH	DIAMETER INCH	SYSTEM CONNECTION	ASSEMBLY WEIGHT LBS.
		20-40 PSI	30-50 PSI	40-60 PSI				
WX-202-U/G	20.0	7.4	6.2	5.4	29-3/4	15 3/8	1" NPTF	33
WX-250-U/G	44.0	16.3	13.6	11.9	33-3/8	22	1-1/4" NPTF	63

Appendix B.3 Variable Frequency Drive Pumps and Motors

A variable-frequency drive (VFD) is an electronic controller that adjusts the speed of an electric motor by modulating frequency and voltage. VFDs provide continuous control by matching motor speed to the specific demands of the work being performed. VFDs allow operators to fine-tune pumping systems while reducing costs for energy and equipment maintenance.

Use in potable water systems

VFDs are becoming more popular at water facilities, where the greatest energy demand most often comes from pump motors. VFDs enable pumps to accommodate fluctuating demand, running pumps at lower speeds and drawing less energy while still meeting water system needs.

Benefits

Single-speed drives start motors abruptly, subjecting the motor to high torque and current surges up to 10 times the full-load current. In contrast, variable-frequency drives offer a “soft start” capability, gradually ramping up a motor to operating speed. This lessens mechanical and electrical stress on the motor system, reduces maintenance and repair costs, and extends motor life.

VFDs allow more precise control of processes, such as water production and distribution. They can also maintain pressure in water distribution systems to closer tolerances. Energy savings from VFDs can be significant. Affinity laws for centrifugal pumps suggest that a reduction in motor speed will generate energy savings. While motor speed and flow are proportional (e.g., 75% speed = 75% flow), motor speed and horsepower have a cubed relationship (e.g., 75% speed = 40% power consumption). Despite some of the VFD controller’s additional energy requirements VFDs can reduce a pump’s energy use over many single speed pumping applications.

Pumps may be designed and installed for the built-out condition, and operate economically and efficiently for the many years it will take to reach the full demand design condition.

Disadvantages and Design Challenges

- Outdoor installations can be a problem because VFDs cannot tolerate extremely cold weather. Check the manufacturer’s specifications for ambient air temperature limitations.
- VFD controllers are sensitive to high temperature, humidity, and particulates. Consult the manufacturer on the need for air conditioning and air filtering.

- Without special provisions, placing the controller more than 100 feet from the motor can be a problem. Check with the VFD manufacturer for specific requirements.
- Power and control wires must be in separate conduits.
- VFDs only work on three-phase motors, except in very small pump applications.
- VFD-controlled pumps may not meet the minimum water flow required to keep the motor winding cool. Make sure the pump is not operating below that speed. Sleeving may be an option to protect the pump motor. Confirm with the submersible pump manufacturer the minimum flow rate across the motor needed for motor cooling.
- The quality of the power coming into the VFD controller can significantly affect controller performance. Monitor voltage fluctuations before installing a VFD controller.
- The resonant frequency of the pump and motor should be checked and accommodations made if the resonant frequency is within the range of expected pump speeds.
- Experienced electronics personnel will be required for maintenance and repair.

When designing a VFD pumping system

Certain rotational speeds may induce resonance and excessive vibration. Designers should check with the manufacturer about the resonant frequency of the pump or motor, and find out whether that frequency could be induced by a speed within the predicted operating range of the pump.

The designer should reference the minimum flow requirements of the pump when establishing the operating range of the pumping system. Each manufacturer will have its own specific requirements for pressurized storage volume to ensure compatibility with the specific low-flow pump off discharge rate, ramping speed, and the system control pressure range.

Appendix B.4 Tracer Study Checklist

Tracer studies are simple in concept; you add a tracer prior to the inlet of a structure and measure the concentration at the outlet. However, conducting a tracer study that gives you meaningful results can be very challenging. To maximize the potential for success, you **must** submit a tracer study plan to DOH before conducting a tracer study (WAC 246-290-636(5)). This checklist provides general expectations for the information you should include in a tracer study plan.

General Information

Provide the purpose of the study and basic information about the facility. In addition, please provide the following information:

- The names, titles, and qualifications of the persons conducting the study.
- A description of the plant and how it is operated, including range of flows, operating levels, and operational controls. Note if laminar flows due to low velocity occur.
- An overview of how the study will be conducted.
- A schematic of the part(s) of the facility through which the tracer will pass, showing:
 - Point of tracer addition.
 - Other chemical additions (such as disinfectants, fluoride, etc.) and sampling locations used for normal process monitoring.
 - Tracer sampling locations (after tracer addition, after flow passes through the structure(s), and other locations as needed).
 - Flow meters.
- Dimensions, depth(s), and volume(s) of the part(s) of the facility assessed, including:
 - Length to width (or depth) ratio
 - Cross-sectional velocity and associated Reynolds number under normal operating conditions (see Porter et al 2018).
 - special conditions such as parallel, sequential or segmented basins

Tracer Study Plan

You should include the following information in the tracer study plan:

- Tracer
- Type of test
- Sampling schedule
- Flow rates
- Data and instrumentation

- Procedures to confirm that water level/flow rate instrumentation or measurement is accurate.
- Field verification of basin dimensions and configuration details.

Tracer

There is no one ideal tracer. For the best results, the tracer must be conservative. That means it cannot react over the period of the tracer study. The most commonly used and reviewed ones are fluoride, lithium, sodium, chloride, and calcium. Sometimes conductivity is used as a surrogate when sodium chloride is used as a tracer. Reactive tracers, such as hypochlorite, can be used in limited cases where the tracer study time is short, and preliminary tests have demonstrated that there is little or no decay of the tracer under the conditions of the proposed test.

- Information about the proposed tracer should include:
 - Rationale for selected tracer.
 - Sampling locations (after tracer addition, after flow passes through the structure(s), and others as needed).
 - ANSI/NSF Standard 60 approved dose or acceptable alternative.
 - How solution will be prepared.
- Target dose
- Background/baseline level of the tracer.
- Injection method (saturators should not be used. A premixed solution is best).
 - Identify how tracer will be dispersed into the flow stream.
- Identification of lag times between the flow path and point of sample collection.
- Analytical method (range, sensitivity, accuracy, field or laboratory analysis).

Type of Test

The two main types of tracer studies are step dose tests and slug dose tests. Slug dose tests can result in density current effects because very concentrated solutions are needed to conduct the study. We recommend using a step dose approach because of this issue and other disadvantages of the slug dose approach. We will only accept the use of a slug dose approach if you submit a thorough and adequate justification for review and approval.

Sampling Frequency and Duration

It is important to sample for the tracer often enough, especially shortly after the start of the test, so that the baffling efficiency (T_{10}/T) can be clearly identified. T_{10} is the time it

takes for 10 percent of the tracer to break through and T is the mean hydraulic residence time. You can use the following framework from Teefy (1999) for step dose tests.

Period	Time between samples
Start to 0.25T	0.025T
0.25T to 1.5T	0.042T
1.5T to 2T	0.050T
2T to 3T	0.100T
3T to 4T	0.200T

You should also collect samples shortly after the point of tracer injection (at or near the inlet of the basin) at a frequency of 0.10T to confirm constant tracer addition and accurately estimate tracer recovery. In addition, flow and clearwell level measurements should be collected continuously. The duration should be sufficient to achieve at least 95 percent recovery of the tracer.

In some cases, it may be difficult to maintain a constant level in a clearwell and flow for four hydraulic residence times. In these cases, you can use a shorter step dose test, but it should not be shorter than the calculated mean hydraulic residence time, especially in well-baffled structures.

Flow Rates

You should conduct tracer studies at three and preferably four different flow rates, spaced out over the range of normal low, average, and peak flows. The basic premise is that the baffling efficiency (T_{10}/T) should be fairly constant over the range of flows tested. Studies have shown that the baffling efficiency is slightly lower at lower flow rates. However, a significant variation in baffling efficiency may reveal issues with ways the tracer study was conducted or even issues with the facility, such as construction anomalies. The highest flow rate tested should be at least 91 percent of the peak hourly flow expected through the portion of the facility evaluated (USEPA 1990).

- Provide an explanation for the determination of peak hourly flow (including historical flow data and any supporting calculations).

You can use computational fluid dynamic (CFD) modeling conducted over multiple flow conditions to minimize the number of flow conditions tested in the field. You need to conduct at least one field tracer test, after you submit the CFD modeling results, to validate the CFD modeling results.

You should anticipate changes in flow due to backwashing, finished water pump operation, or other routine plant operation, and minimize or address them during the study. For higher flow rates, you may need to address practical considerations, such as where to put the excess water. At higher flow rates, it may be necessary to conduct tracer studies in the summer to take advantage of increased demand.

Data and Instrumentation

The instrumentation used in the tracer study test is critical in the evaluation of the tracer study data. The instruments of interest include the chemical test equipment as well as flow meters. Please provide the following information on tracer study data and instrumentation.

- Analytical method (range, sensitivity, accuracy, field or laboratory analysis).
- Identify the field and facility instruments used in the tracer study.
 - Make and model of instrument(s).
 - Calibration date of instrument(s).
 - Reagents used in test and associated expiration dates.
 - Sensitivity range of equipment.
- Level measurements (if the water level can vary during the test)
 - Method for maintaining a near-constant water level.
- Provide a copy of the proposed field data sheets. Each data sheet should include the following.
 - Flow, level, temperature, and tracer measurements.
 - The instrument used to obtain the data.

Presentation of results

- Templates (forms, tables or graphs) you will use to present the results
- Instructions explaining how to use the results to complete daily CT monitoring, including a method for determining peak flow (inflow, outflow).
- CFD modeling results, if applicable.

References

- Porter R.L., Stewart K.P., Feagin N., Perry S. 2018. Baffling efficiency insights gained from tracer studies at 32 Washington treatment plants. *AWWA Wat Sci.* ;e1115.
- Teefy, S. 1996. *Tracer Studies in Water Treatment Facilities: A Protocol and Case Studies*. AWWA Research Foundation. Denver, CO.
- USEPA 1990. *Guidance Manual for Compliance with the Filtration and Disinfection Requirements for Public Water Systems Using Surface Water Sources – Appendix C: Determination of Disinfectant Contact Time*. United States Environmental Protection Agency, Washington, DC.

Appendix C: List of Agencies and Publications

Here are addresses and phone numbers for each agency's main office or location. Many of the agencies also have local or regional offices that offer services. This list of agencies and the information they provide is not intended to be all-inclusive.

Organization Name	Organization Type	Telephone and Web Site	Information or Publications Available
U.S. Environmental Protection Agency (EPA) Region 10	Federal	(206) 553-1200 or (800) 424-4372 (general) http://www.epa.gov/r10earth/ https://www.epa.gov/ground-water-and-drinking-water	All topics related to the Safe Drinking Water Act
Center for Disease Control and Prevention	Federal	800-CDC-INFO (800-232-4636) TTY: 888-232-6348 https://www.cdc.gov/fluoridation/index.html	Fluoridation information
National Oceanic and Atmospheric Administration	Federal	(206) 526-6087 (Weather Service - Seattle) http://www.weather.gov/sew/ Climatic Data Center https://www.ncdc.noaa.gov/	Climate information
Occupational Safety and Health Administration (OSHA)	Federal	https://www.osha.gov/	Employee and construction safety

Organization Name	Organization Type	Telephone and Web Site	Information or Publications Available
Department of Ecology	State	Water Resources Program: http://www.ecy.wa.gov/programs/wr/wrhome.html Well Report Viewer: https://fortress.wa.gov/ecy/waterresources/map/WCLSWebMap/default.aspx River and Stream Flow Data: http://www.ecy.wa.gov/programs/eap/flow/index.html Water Quality Program: http://www.ecy.wa.gov/programs/wq/wqhome.html Hazard Waste and Toxics Reduction Program: http://www.ecy.wa.gov/programs/hwtr/index.html Phone: 360-407-6000 (voice) 800-833-6388 (TTY) Publications: https://fortress.wa.gov/ecy/publications/UIPages/Home.aspx	<ul style="list-style-type: none"> - Water rights - Well logs - River and stream flow data - Criteria for sewage works design - Disposal of chlorinated water - Dam safety - Well construction standards - Disposal of WTP backwash - Hazardous waste disposal
Department of Health Office of Drinking Water	State	(360) 236-3100 (800) 525-0127 TTY users dial 711 http://www.doh.wa.gov/ehp/dw Publications: http://www.doh.wa.gov/CommunityandEnvironment/DrinkingWater/PublicationsandForms	<ul style="list-style-type: none"> - Water System Planning Guidebook - Small Water System Management Program Guide - Water use efficiency information - Group B Design Guidelines - Fact sheets - Approved Backflow Assemblies List - Training opportunities

Organization Name	Organization Type	Telephone and Web Site	Information or Publications Available
			<ul style="list-style-type: none"> - Drinking water rules, policies and other guidelines - Subject matter experts and technical assistance contacts
Department of Labor and Industries (L&I)	State	(360) 902-5800 (Main) TTY: 1-800-833-6388 (360) 902-5500 (WISHA) (360) 902-5226 (Plumbing and Contractor Registration) (360) 902-5270 (Boiler and Pressure Vessels) http://www.lni.wa.gov/	<ul style="list-style-type: none"> - Safety rules - Work in confined spaces - Working with asbestos-cement pipe - Statutes and rules on boilers and pressure vessels - Plumber certification and contractor registration
Department of Natural Resources	State	(360) 902-1000 (Main) (360) 902 1450 (Geology and Earth Sciences) http://www.dnr.wa.gov/	Liquefaction susceptibility maps
Department of Transportation Standard Construction Specifications	State	(360) 705-7430 http://www.wsdot.wa.gov/Business/Construction/SpecificationsAmendmentsGSPs.htm	<ul style="list-style-type: none"> - Technical and construction manuals - Standard specifications

Organization Name	Organization Type	Telephone and Web Site	Information or Publications Available
State Building Code Council (SBCC)	State	(360) 407-9277 https://fortress.wa.gov/es/apps/SBCC//	<ul style="list-style-type: none"> - International Building Code - Uniform Plumbing Code - International Fire Code
Office of Washington State Climatologist (OWSC)	State	(206) 543-3145 http://www.climate.washington.edu	Historical climate information
Office of the State Fire Marshal	State	(360) 596-3900 http://www.wsp.wa.gov/fire/firemars.htm	<ul style="list-style-type: none"> - Fire prevention information - Fire sprinkler information
Utilities and Transportation Commission (UTC)	State	(360) 664-1300 https://www.utc.wa.gov/regulatedIndustries/utilities/water/Pages/default.aspx	Requirements related to inventory owned water systems (water companies)
American Water Works Association (AWWA)	Professional	(303) 926-7337 https://www.awwa.org/	<ul style="list-style-type: none"> - Standards - Water Research Foundation reports - Manuals - Standard methods - Various journals and periodicals
Pacific Northwest Section – AWWA (PNWS-AWWA)	Professional	(503) 760-6460 http://www.pnws-awwa.org/	<ul style="list-style-type: none"> - Brochures - Bill stuffers - Cross-Connection Control Manual - Training Opportunities
Health Research Inc., Health Education Services Division	Regional	(518) 439-7286	Ten States Standards

Organization Name	Organization Type	Telephone and Web Site	Information or Publications Available
NSF International (formerly the National Sanitation Foundation)	Audit and Certification	800-673-6275 http://www.nsf.org/	- List of NSF-approved products - NSF Standards
University of Southern California (USC) Foundation for Cross-Connection Control and Hydraulic Research	Academic	866-545-6340 http://www.usc.edu/dept/fccchr	- Approved Backflow Assemblies List - Manual of Cross-Connection Control
Washington Surveying and Rating Bureau	Professional	(206) 217-9772 http://www1.wsrb.com/wsrbweb/	Insurance ratings
Western Regional Climate Center	Academic	(775) 674-7010 https://wrcc.dri.edu/	- Climate data - Rainfall data

Appendix D: Estimating Water Demands

Appendix D.1 Background and Development of Residential Water Demand vs. Precipitation

Appendix D.2 Estimating Nonresidential Demand

Appendix D.3 Deriving Maximum Daily Demand to Maximum Month Average Daily Demand Ratio

Appendix D.1 Background: Residential Water Demand vs. Precipitation

Appendix D.1 is a study originally published in the 1999 Water System Design Manual. We present D.1 to support the design of new water residential-only systems without metered data or analogous water system data to estimate the ERU_{ADD} and ERU_{MDD} .

Data Collection

A basic tenet for the revised design standards was to provide a conservative basis for designing new water system development, or extensions to existing development, whenever more reliable historical data was unavailable. It was recognized that a basic design parameter such as residential water demand may be better estimated if it could be based on available information throughout the state that could be both accessible and reliable. Information gained from water system records throughout the state, or from other locales with residential developments similar to this state, would be useful and generally more applicable to the establishment of a general design standard.

In attempts to secure accurate water use data from all parts of the state, we used three sources of information—two from DOH surveys and one from reviews of documented information contained in various DOH-approved Water System Plans (WSPs). An additional source of information was a report the California Department of Water Resources prepared.

An initial (1993-94) survey questionnaire was sent to 30 selected utilities representing a uniform geographical distribution throughout the state. This survey was intended to determine a complete accounting of all water uses experienced by the utility from which specific data regarding residential uses could be derived. Questions were asked for number of metered accounts, total annual water demand, total population served, recorded average annual demands for all types of accounts (residential, industrial, commercial), multifamily uses (if possible to discern), recorded maximum day demands, and estimates of unaccounted water uses. The information was requested for the three year period, 1990-92. Also, the average annual rainfall for the utility service area was requested, if it were known by the utility. Where rainfall data was not provided by the responding systems, rainfall levels were determined from Meteorological Service records for the gauging station within, or nearest to, the utility.

For the 19 survey responses received from the initial questionnaire, the information was analyzed in an attempt to identify the water demands associated only with residential uses. This data was in turn correlated with rainfall records for the area. Of the survey responses returned, nine were of sufficient detail that residential demand estimates

could be made with a relatively high degree of confidence. Information regarding maximum daily demands was generally not readily available, although in some instances water systems did present estimates of maximum day uses based on ratios to their peak monthly demands. The ratios of maximum day use to peak month use ranged from 1.4 to 2.7 for those utilities providing an estimate.

Because the results of the initial survey were insufficient to develop generalized relationships useful for design standards, a second survey was conducted in early 1995. Thirty-eight (geographically distributed statewide) water utilities were asked for more directed information. Under the logical premise that irrigation demands were strongly associated with residential lot size, questions were asked regarding specific metered residential accounts in service locations where residential densities could be determined (i.e. utilities were asked to provide actual meter data from 20 to 30 accounts located in portions of their service area which ranged from a low density of one or less services per acre to a high density of five services per acre). The year for which utility meter records were to be reviewed and assessed was 1993.

Twenty-six systems responded to the survey and presented information based on actual 1993 meter readings for residential accounts, and where possible, an estimate of the residential density (ranges requested were for one or fewer units per acre, two units per acre, three units per acre, four units per acre, and in some cases, five units per acre) for those locations in their systems from which the meter records were taken.

The analysis of this information provided somewhat more direct, and presumably more accurate, estimates of annual residential water demands. Since 1993 was unusual in that the summer period experienced higher than normal rainfall, the demand data were related to the rainfall records for that year rather than using average annual rainfalls.

Analysis of the relationship of water demand to lot size, although generally showing that higher demands were related to larger lot sizes, and that this aspect was especially pronounced for lots in excess of an acre as compared to higher density developments (especially in eastern Washington), was not supported by sufficient unequivocal data to allow formulation of quantifiable design relationships.

However, the design engineer is to be cautioned that the size of residential lots, especially in eastern Washington, is clearly influential on the expected water demands, particularly for lots larger than an acre in size. As much as 60 percent more water may be used by a residence on an acre-plus lot than on lots which are less than an acre. The engineer must be aware of this aspect, and will be held accountable for proper

consideration of this factor, when estimating water demands for tracts with large lot sizes.

Additional (and considered reliable), information on residential water demands was also found through reviews of 28 Water System Plans (WSPs) which had received DOH approval in 1995 to early 1996. The information from these WSPs was specific to residential water demands associated with meter readings or from professional engineer estimates. These data were then related to the rainfall records information documented in the WSP or from data on file with the Meteorological Service for gauging locations proximal to the utility.

Additional information was also collected from a 1994 report prepared by the California Department of Water Resources (Bulletin 166-4, "Urban Water Use in CA," August 1994). Included in this report (which provided a wide array of recorded water use patterns specific to utilities or geographic areas in California) was some summary data for twenty selected utilities which associated a ten-year average annual demand (on a per capita basis) to average annual rainfall. Using a factor of 2.7 persons per Equivalent Residential Unit, estimates of the average annual demands for 19 of these utilities (in terms of gallons per day per ERU) were made and incorporated into the data set used for this demand analysis. (One utility, Palm Springs, had demands that were influenced so greatly by an abnormally large transient population that it could not be considered reflective of a true residential community, and was therefore not included in the data set).

Data Analysis

The data (a total of 122 data points) were evaluated in an attempt to identify and characterize any discernable relationships. Although it was recognized that many factors exist which could influence residential water demands, with the exception of average annual rainfall there appeared to be insufficient information to draw relationships with any other factor which could be used as a numerical and rational basis for specifying design parameters. In earlier drafts of the revised design standards, factors were developed and proposed to account for water demand influences associated with residential density. From the data available there was clear evidence that lot size was related to water use in both Western and Eastern Washington. However, the data were limited and could not be reasonably applied to specific relationships descriptive of statewide observations. The impact of lot size was, therefore, not accounted by some design relationship, but was addressed as a qualitative aspect of design, which must be considered and addressed. For other factors (such as economic status, pricing structure, landscaping practices, conservation practices, etc.) which can be of significant influence on water demand, there was insufficient information to draw any relationships or

qualitative conclusions. Some water systems may have in the past developed specific relationships between several of these factors and their water demands, but such relationships would be specific to an individual system and would not be applicable on a statewide basis, unless they could be verified through collection and analysis of additional and reliable information.

Development of Rainfall/Residential Demand Relationship

The data were plotted in an x-y scatter plot and visually inspected. From an examination of the plotted data, there seemed to be a generalized relationship between average annual demand for residential developments and average annual rainfall. It was apparent that use of a single value for demand estimates on a per household basis (as has been historically the practice), for the design of residential water systems was not particularly appropriate. A curvilinear function appeared to be more descriptive of average water demands when associated with such a climatic factor as average annual rainfall.

Accepting that the data could be better described by a curvilinear function, several different fitting models were used to develop best-fit curves for the data. Figure D-1 presents two best-fit curves, one based on a hyperbolic function, and a second based on a power function. Both provide similar fits to the data set, with correlation coefficients (R) of 0.49 and 0.61, respectively. Although these correlations are not as strong as one would like to develop basic relational equations, they were considered sufficient to allow acceptance of the general form of a function which could be used for water demand design criteria. The data scatter in the low rainfall areas contribute significantly to the marginal correlations with rainfall which points out the influence of other factors in determining average daily demands for residential populations.

Figure D-1
Power and Hyperbolic
Function Best Fit Curves

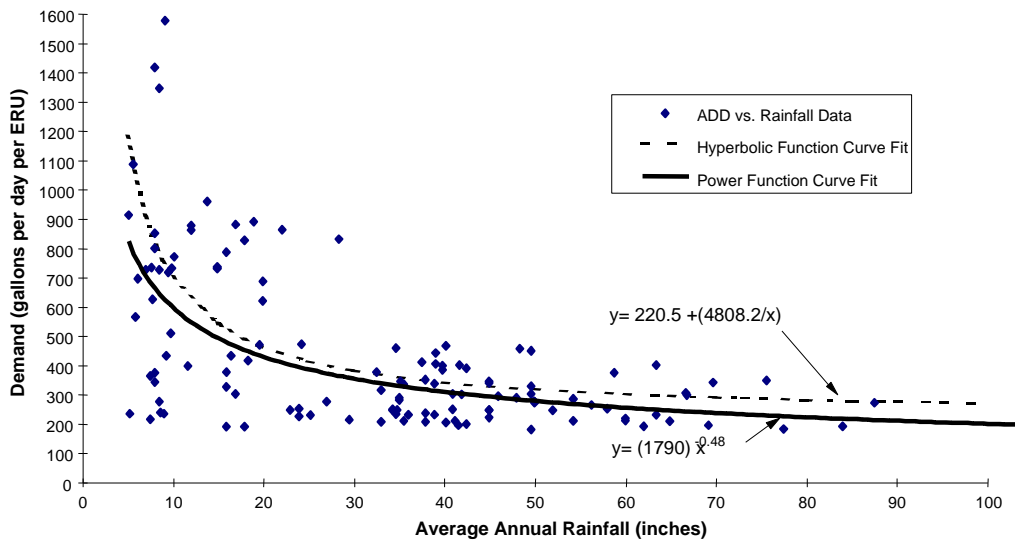

In order to determine confidence intervals (C.I.s) for the mean of the data set, and more usefully in this application, prediction intervals for individual points, the data were transformed to develop a linear relationship. A log x-log y transformation provided a data set with a linear regression line corresponding to the best-fit power function curve. The linear regression line for the plot of y vs. 1/x corresponds to the hyperbolic function. The transformed data and appropriate C.I.s are presented in Figures D-2 and D-3, and were developed using SPSS statistical software.

Mean and Point Prediction Intervals at 60%

The centerline in Figures D-2 and D-3 represent the mean of the data set. The curved lines on each side of the center line are the 60 percent confidence bounds for the mean of the data, and the parallel lines at the outer portions of the data are the 60 percent Prediction Intervals for individual points. That is, based on the data available, and standard assumptions about the validity of that data as representative of the larger population, it can be said with 60 percent certainty that usage, as a function of rainfall, of any new data point will fall between the two outer, parallel lines. It is noted that although 60 percent represents a relatively marginal level of confidence, the notable data scatter in the low rainfall range biases these results.

Figure D-2: Log Transformation of Average Day Demand vs. Rainfall (Power Function)

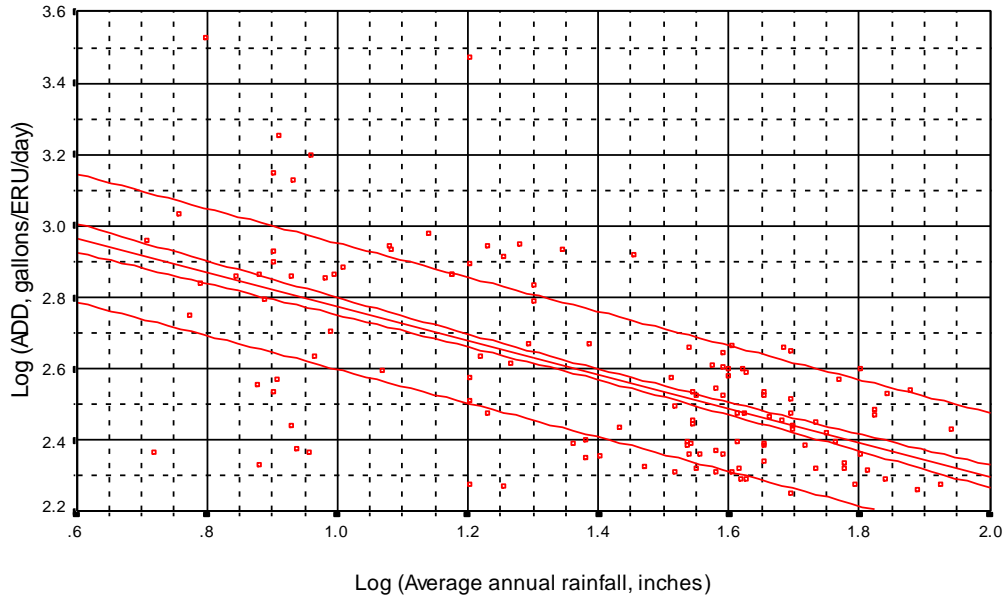
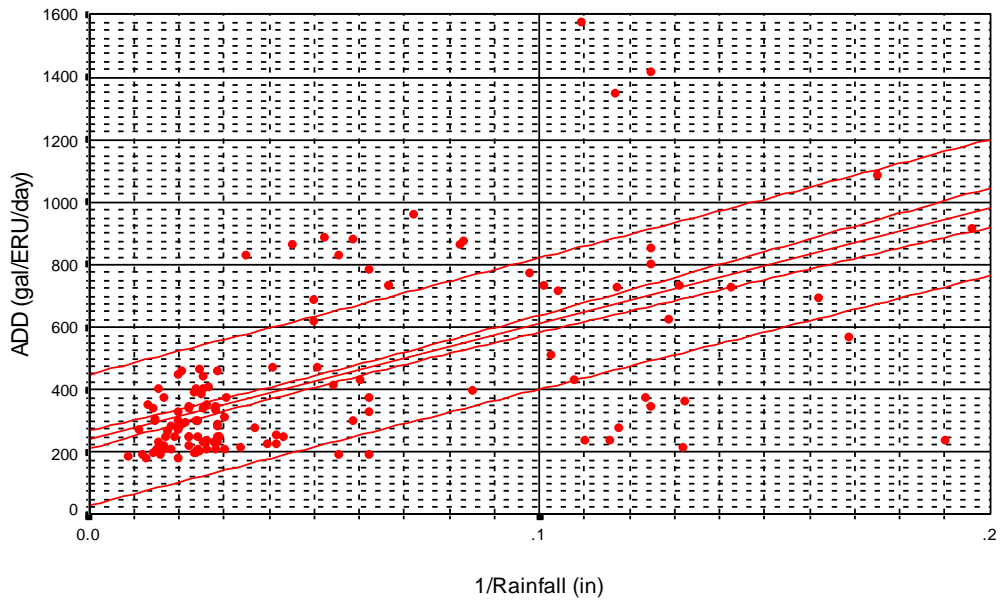

Figure D-3: Transformation of Average Day Demand vs. Reciprocal of Rainfall (Hyperbolic Function)



An upper level curve for the Power Function based on the 60% confidence boundary, when plotted back to arithmetic coordinates, indicates that 85% of all points are below the upper bound. For rainfalls averaging less than 30 inches per year, almost all points are below the upper bound.

Review of Figures D-2 and D-3 indicates that transforming the data based on a hyperbolic function (i.e. y vs. $1/x$) provides a slightly poorer linear relationship than the power function. However, the difference was not considered of such significance that use of a hyperbolic relationship could be discounted.

Baseline Residential Water Demand

The data (shown in Figure D-1) shows an interesting aspect which appears to have general application and credence for baseline residential water demands. With only a few exceptions where a few data points can be seen to be lower, all data generally lied above a value of 200 gpd/ERU (i.e., at all rainfall levels, the average annual demands reported were greater than 200 gpd/ERU). This observation may be construed as a threshold level for residential demands which appear to be independent of average annual precipitation levels and may indicate the base level of demand associated with internal household (non-irrigation, etc.) uses. As such, the function which describes the relationship between ADD and average annual rainfall would be more strongly associated with external household uses (irrigation, lawn watering, etc.). Assuming this is the case, design requirements for total demands could be separated into two components - one related to internal uses and the other to external uses. For internal demands, a constant value independent of rainfall could be prescribed and for external demands, a relational function could be established which was dependent upon rainfall levels.

From the data, the single valued level for average annual household demands (internal uses), which would appear to apply statewide independent of rainfall, is about 200 gpd/ERU. Logic dictates that this demand may be consistent on an average annual basis, but cannot be expected to be uniform on a day to day basis. Residential households would be expected to experience peak demand days for internal uses associated with a number of factors. Peak day uses could be expected with increased water demands for showering in the summer, or when visitors or relatives are entertained. The actual levels associated with the peaking demand days would be dependent upon many variables. There were no known relational studies, or anecdotal accounts, that could be found which would assist in development of design parameters for internal household peaking uses. Nonetheless, in order to maintain consistency with stipulations of the state's Group B water system design criteria, and with the Department of Ecology, who in some instances provides estimates of peak day internal uses for water rights issues, a

reasonable level for a Maximum Daily Residential Demand for internal uses can be established at 350 gpd/ERU (a value which can be seen is marginally less than double the average annual internal demand of 200 gpd/ERU previously discussed).

For projects that propose to have separate irrigation systems, the design of the potable (internal use) water system can be predicated on the estimate of 350 gpd/ERU. The irrigation portion of the system may be designed based on the respective needs of the customers, or by using the difference between the demand estimated for complete service (Maximum Total Daily Demand) and that for just the internal uses (Maximum Internal Daily Demand).

Selection of Design Functions for Residential Water Demands

In development of a functional design relationship which can be used for estimating the residential water demands in Washington State a number of approaches were examined:

- Based on the statistical features of the data set, a function that described the relationship associated with the upper bound of the 60% confidence interval could be used.
- The current approach that sets demand levels at constant values for Eastern and Western Washington could be retained. However, this "status quo" approach may not be particularly applicable based on a review of the data. There appears to be a trend better described by a continuous function rather than by a single, but separate, value ascribed to water system design simply because of gross climatic differences between East and West Washington.
- Another approach would be to establish a function that gives criteria higher than any recorded data to insure that, at least, the data set available was completely accounted in a highly conservative manner.

The foregoing approaches were all rejected under criteria that were believed appropriate to guide the design function selection process. It was considered reasonable and prudent to establish an approach that would provide for a relationship that was patterned to the "best-fit" curves developed for the data that were sufficiently conservative so that reasonable confidence could be placed on the use of the design relationship (i.e., the function would describe demands that were in excess of at least 80% of the recorded data), that the relationship would be as simple as possible to use and understand, and that the relationship would be asymptotic to a baseline demand of 200 gpd/ERU.

In addition, based on the wide range of reported data in the low rainfall range which showed some, but very few, systems that experienced very high average annual

demands (> 1000 gpd/ERU), it was determined appropriate to establish an upper boundary of 1,000 gpd/ERU for any relationship (function) that was developed.

Under these criteria, two functions were developed, one a power function and the other a hyperbolic function, which were asymptotic to the 200 gpd/ERU lower boundary and which were presented in very simplistic terms. Another function was also developed, which does not show an asymptotic boundary associated with the 200-gpd/ERU level, but does parallel the best-fit power function relationship used for the previous data analysis. Each of these functions is conservative in that 80% or more of the data would lie below the curves describing the functions. Presented in Figure D-4 are three graphical relationships with their associative functions. One hyperbolic relationship and two power function relationships are presented, any of which may be used to estimate residential water demands throughout the state when no other better information is available or applied for design.

Although the power function relationship may have somewhat greater statistical strength, the relatively high conservative nature of these functions would allow for any of them to be used for design purposes. Since the hyperbolic function provides more conservative estimates at lower rainfall ranges, and is possibly the simplest to use and understand because of its arithmetic nature, it was selected as the function of choice for estimates of average annual residential demands used for project designs **when more appropriate information is not available.**

Maximum Day Demand

A variety of peaking factors have been reported in the literature and within the data collected for this analysis, but generally the Maximum Daily Demand (MDD) is 1.5 to 3 times average daily demand. By selecting an appropriately conservative approach to estimating ADDs (as was done in this analysis), use of a standard peaking factor of 2.0 was considered to be adequately conservative. MDD can therefore be calculated by multiplying ADD values by a factor of 2.0. Again, an upper maximum level would be established based on the upper boundary for the average annual demand (1000 gpd/ERU). The MDD value would be 2000 gal/day/ERU as an upper bound. The absolute lower limit MDD values, as previously discussed, are set at 350 gpd/ERU (for developments without irrigation or with restrictions on the external use of water).

Limitations of This Analysis

It is clear from inspection of the graphs presented in this appendix that the data varies widely, and the existence of many other factors that affect both average annual and peak daily water use have been acknowledged. **The intent of this document is to ensure that new systems, or system improvements, are designed based on**

reasonable and conservative criteria when there is an absence of sufficient production and use data to allow other design parameters to be used. The approaches presented here reflect this philosophy, and as such, have tried to use relatively sparse data in a reasonable and judicious manner. The water demand design criteria contained in the Design Manual (Chapter 3) represent an improvement over what has historically been used in the state. In the future as more and better information becomes available, even greater refinement of the approaches can be expected.

FIGURE D-4

Functional Relationships Describing Average Residential Demand Relative to Average Annual Rainfall Levels

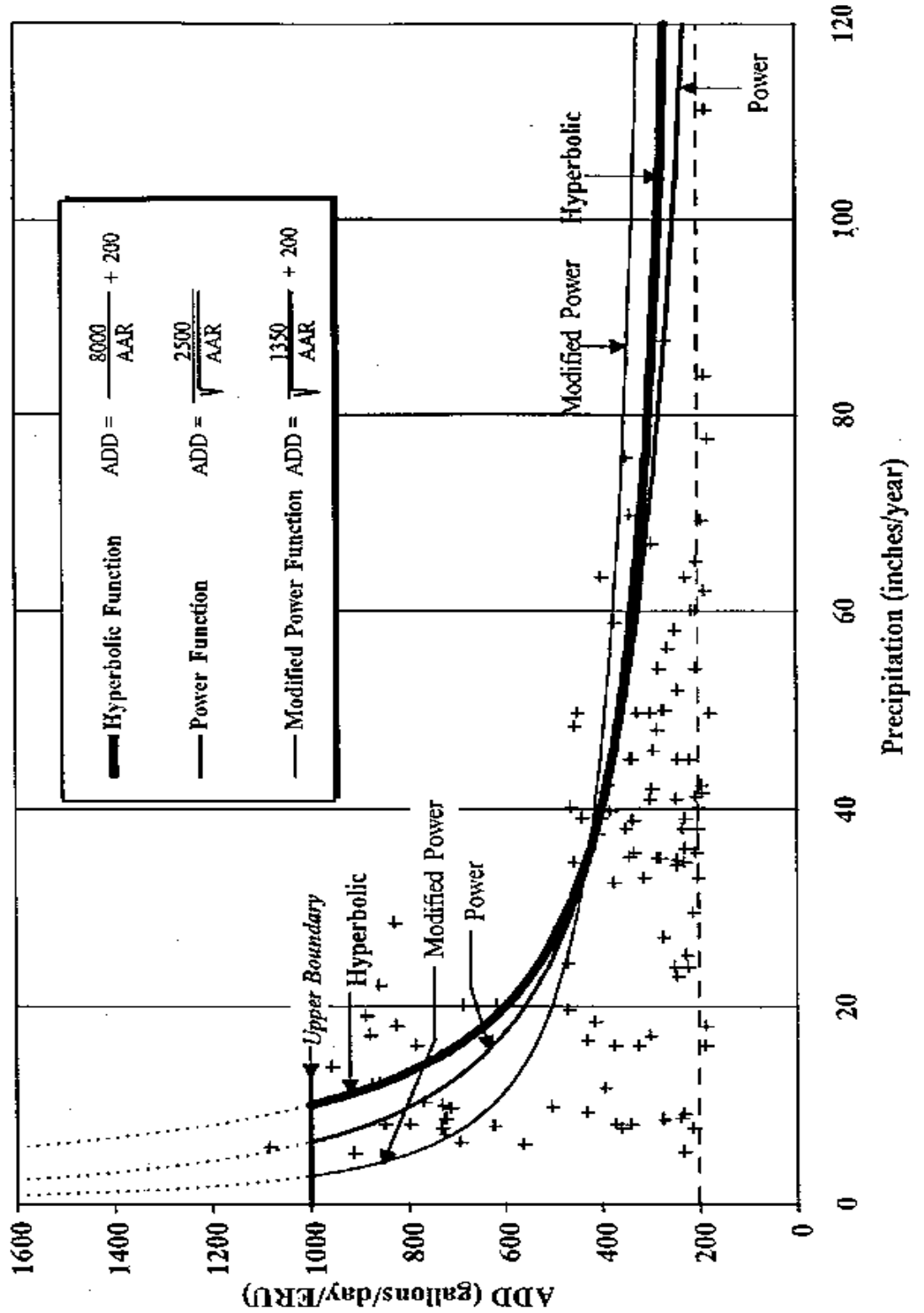

Appendix D.2 Estimating Nonresidential Demand

Table 3-2 in Chapter 3 of this manual provides guidance on estimating nonresidential maximum daily demand (MDD). Design engineers should apply the following assumptions when using the values presented on Table 3-2:

- Unit nonresidential demand will vary little from day to day.
- MDD is based on a full facility (the campsite or hotel is fully occupied or the school is operating at capacity).

Tables 1 and 2 provide guidance on establishing nonresidential peak hour demand (PHD) using the fixture method.

Table 1
Demand Weight in Fixture Units

Fixture Type	Weight in Fixture Units per Fixture Type
Shower	2
Kitchen sink	1.5
Urinal	3
Toilet (flushometer)	5
Toilet (tank flush)	2.5
Bathroom sink (lavatory)	1
Clothes washer	4.0
Drinking fountain	0.5
Dishwasher	1.5
Hose bibb	2.5

Source: Adapted from the 2009 Uniform Plumbing Code, Appendix A, Table A-2

After determining the total number of fixture units (sum of fixture type times fixture weight), round the total to the next value given in Table 2, and determine the peak hourly demand.

Table 2
Conversion of Fixture Units to Nonresidential Peak Hourly Demand

Total Number of Fixture Units	PHD (gpm)	Total Number of Fixture Units	PHD (gpm)
10	8	50	29
15	12	60	32
20	15	70	35
25	18	80	38
30	20	90	41
35	22	100	43
40	25		

Source: Adapted from the 2009 Uniform Plumbing Code, Appendix A

Example

A proposed catering business in Western Washington will employ 30 daytime employees and have no visitors. The proposed building will have its own drinking water system, using a permit-exempt well. The area around the building to be irrigated is 3,000 sq. feet. A fire pond filled by a nonpotable water supply will meet the building's fire-suppression requirements. The fire pond and associated fire-suppression piping have no physical connection with the potable water system.

Step 1: Apply the fixture weight to each fixture type (Table 1), and determine the building's total fixture units.

Fixture Type	Number of Fixtures	Fixture Weight	Fixture Units
Drinking fountain	2	0.5	1
Toilet (tank flush)	4	2.5	10
Urinal	1	3	3
Lavatory	2	1	2
Kitchen sink	2	1.5	1.5
Dishwasher	2	1.5	3
Total			22

Step 2: Round the total fixture units from 22 up to 25 (the next increment in Table 2).

Step 3: Use Table 2 to establish peak hourly demand for internal use within the building. Nonresidential internal PHD is 18 gallons per minute. If the irrigation system is not operated while the building is occupied, then the estimated design PHD should be 18 gpm. If the irrigation system can be operated while the building is occupied, then the design estimate for PHD should include both the internal PHD (18 gpm in this example) plus the peak flow rate of the irrigation system.

Appendix D.3 MDD vs. Maximum Month Average Daily Demand

We analyzed daily water treatment plant data in an attempt to establish a maximum daily demand (MDD) to maximum month average daily demand (MMADD) ratio. For the purpose of this analysis we assumed production was equivalent to total water system demand.

We based the guidance presented in Section 3.4.1 on our analysis of the source production records for 79 water systems using surface water in Washington for the period 2009 through 2014. These systems operate surface water treatment plants and are required to record and report daily source production. The surface water treatment plants are the only routine supply for these 79 water systems, and we used their net treatment plant production information as a proxy for daily system demand (ignoring changes in storage).

We identified the maximum month of production for each year and calculated the MMADD for that month. We then identified within that month the MDD, and for each year and each system calculated the MDD to MMADD ratio. We removed significant statistical outliers from the data set—those outside two standard deviations.

We found strength in correlation between increasing system size and decreasing MDD to MMADD ratio for water systems serving more than **1,000 people**. The larger the system, the more likely it is that the system has access to its own daily source production data. But, if such primary source production data is unavailable, our analysis of the 80th percentile value indicates an MDD to MMADD peaking factor of 1.35 for systems serving 1,000 to 100,000 would be appropriate. We believe applying a 80th percentile threshold for design is appropriate without daily source meter data. The location of the water system was not seen as a factor.

For the 28 water systems serving fewer than **1,000 people**, we found a weak correlation between population served and the MDD to MMADD ratio. In addition, as with the larger system cohort, system location did not matter. From the primary smaller system production data, we determined the 80th percentile value of 1.65 for the MDD to MMADD ratio.

In the 2009 version of the *Water System Design Manual* we recommended a MDD to MMADD ratio of 1.7 for water systems in Western Washington and 1.3 for water systems in Eastern Washington. This recommendation was based on review of a single year of data from 35 water systems. As described above, updated analysis is based on 79 systems reporting water production over a five-year period. Based on this expanded

data set we observed the MDD to MMADD is more strongly correlated to system size and not to system location.

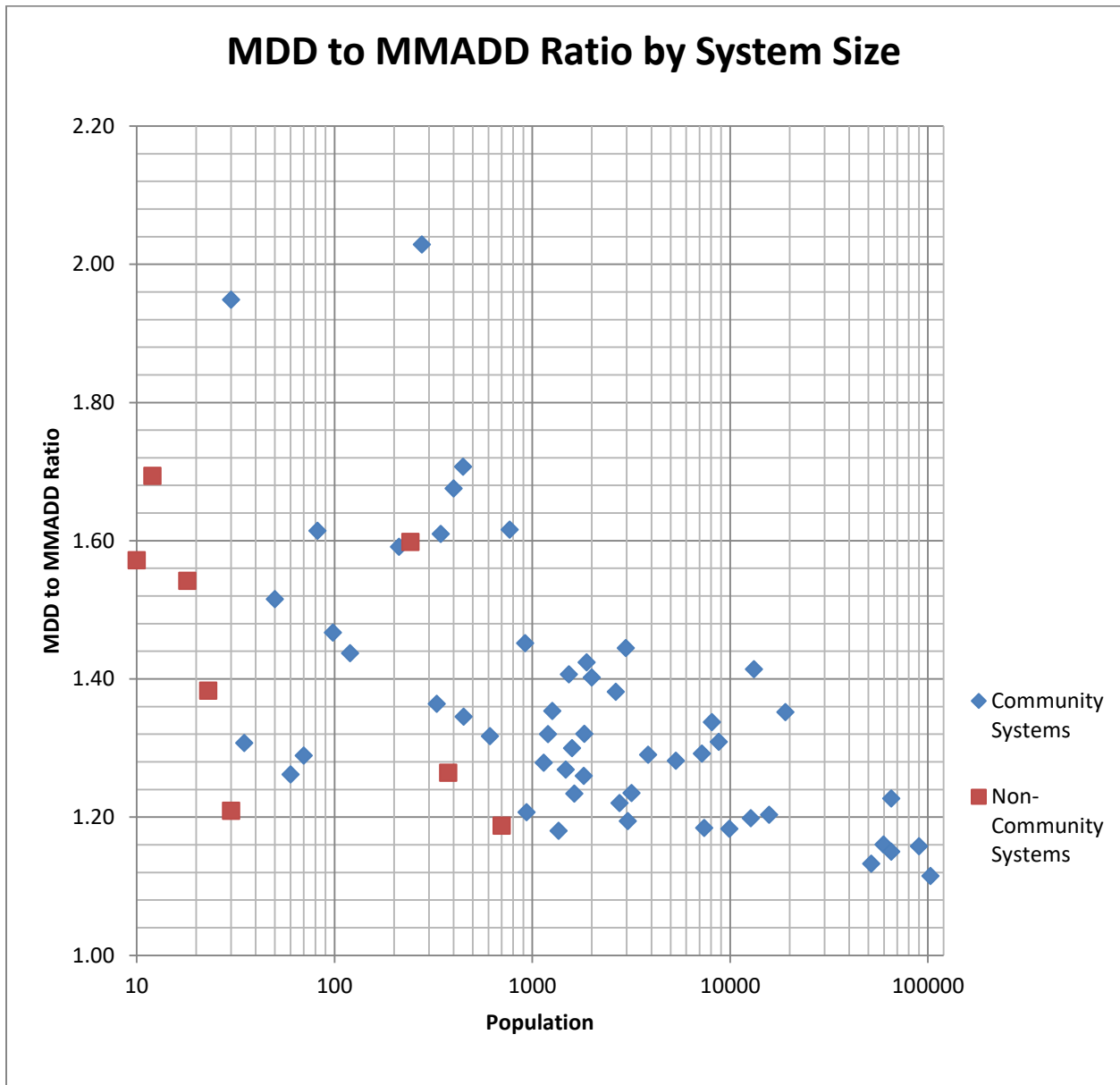

Appendix E: Recommended Pumping Test Procedures

1.0 Introduction

We intend this pumping test guidance to provide Group A water systems with basic information suitable to develop an approach to satisfy source approval requirements in WAC 246-290-130 (3)(c)(iii) and (3)(d). One acceptable approach for demonstrating source reliability is to conduct a pumping test at the maximum design rate and duration, according to WAC 246-290-130(3)(c)(iii).

This guidance explains how to establish the physical capacity and reliability of a new or redeveloped well for the proposed use. This guidance does not address the legal adequacy or availability of water. The Department of Ecology manages the permitting process for appropriating and using the state's water resources. Local government determines water adequacy for the purpose of making local land use and building permit decisions. Contact Ecology and the local government for requirements necessary to demonstrate legal adequacy and availability.

The principal objective of a source approval pumping test is to establish a reasonable estimate of the well's sustainable yield and specific capacity. Once established, these values enable the proper selection and positioning of the well pump in the well.

This pumping test guidance includes:

- Basic approach to pumping tests (Section 2.0)
- Pumping test planning elements (Section 3.0)
- Pumping test methods and analysis (Section 4.0)
- Special aquifer settings and considerations (Section 5.0)
- Pumping test results (Section 6.0)
- Reporting (Section 7.0)
- Potable water supply samples (Section 8.0)

These recommendations represent the minimum criteria for obtaining reliable, useful, and verifiable data. Some hydrogeologic settings may require investigative efforts beyond the scope of this guidance. The design engineer should consult with a licensed hydrogeologist wherever site conditions warrant expertise in the design and evaluation of the pumping test.

As a rule, the more thorough the pumping test and comprehensive the data collection and analysis, the greater the confidence in the assessment of safe yield and specific capacity. It is incumbent upon the design engineer to determine the appropriate scope, duration, and data collection and analysis for each new or rehabilitated source. In so doing, the design engineer should identify and address the degree of uncertainty by applying a suitable factor of safety, water supply contingency planning, or developing redundant water supply facilities.

2.0 Basic Approach to Pumping Tests

For most aquifer conditions, you can adequately define source reliability by conducting step-drawdown and constant-rate pumping tests. If you consider another pumping test approach, contact your DOH regional engineer before submitting your pumping test plan. We recommend conducting pumping tests during periods when the water table is at its lowest (summer and fall months). Bailer tests, air lift tests, and slug tests are not acceptable.

2.1 Step-Drawdown Pumping Test

A step-drawdown test is a single-well pumping test designed to assess a well's performance. It is the most reliable way to determine the pumping rate and pump setting, and it can provide a maximum design pumping-rate you can use for the constant-rate pumping test. The test yields information primarily about the performance of the well rather than aquifer properties and does not require observation well data. The step-drawdown test will likely not identify impermeable boundaries, recharge boundaries, interferences from other wells, or conditions of groundwater under the influence of surface water, unless these conditions exist in very close proximity to the well being tested. For the step-drawdown test, the discharge rate in the pumping well is increased from an initially low constant-rate through a sequence of pumping intervals (steps) of progressively higher constant-rates.

You may not need the step-drawdown test in settings with established water quality and water reliability. For example, when a low-yield source is in an aquifer where existing wells have repeatedly produced high-yield with very little drawdown. Talk to DOH for approval before you start a constant-rate test without conducting step-drawdown test.

Designers may extend the last step of the step-drawdown test and skip the constant-rate test if the proposed well is a low-yield source and they extend the last step until they achieve stabilized drawdown. You should measure post-test well recovery. If you can't achieve stabilization, or the water level fails to return to 95 percent of static water

level measured prior to conducting step-drawdown test after 24-hours, you should perform a constant-rate test.

The designer may skip the step-drawdown test and proceed directly with a constant-rate test if both:

- Water quality and water reliability of the aquifer have been established.
- The proposed well is a low-yield source in an aquifer known to support high-yielding wells with very little drawdown.

You should discuss any variation from the standard step-draw-down test with DOH before starting the pumping test. For example, you should contact DOH before you proceed to a constant-rate test without conducting a step-drawdown test.

Beware when satisfactory stabilized drawdown is achieved and then declines due to poor recharge characteristics of the surrounding material. In such situations, a constant-rate test is required. You also should observe the ability of the water level to recover. If the water level fails to return to 95 percent of the static water level measured prior to the low-yield source step-drawdown test after 24-hours, the reliability of the producing zone is open to question and additional constant-rate testing is required. You will need to submit an explanation and justification of this additional test to DOH for review and approval.

2.2 Constant-rate Pumping Test

The constant-rate pumping test is performed by pumping a well at a constant-rate and measuring drawdown versus time. Most engineers use or install one or more observation wells at an appropriate distance from the pumping well to measure water levels. You should conduct the constant-rate discharge test at the pump setting and maximum design pumping-rate determined from the step-drawdown test. Before the constant-rate test, you should allow the aquifer to recover to within 95 percent of the static water level measured before the step-drawdown test.

2.2.1 Recovery Phase

Water-level measurements obtained during the recovery phase of the constant-rate test are of equal or greater importance than those collected during the pumping phase because they can confirm flow disturbances. The recovery phase is not subject to fluctuations, such as discharge rate variations or well losses. Section 4.0 presents details concerning these data.

3.0 Planning a Pumping Test

You should prepare your pumping test plan and discuss it with DOH for endorsement before starting the test. This planning step supports efficient use of client resources in satisfying the source approval process and in achieving test results supporting conclusions on the safe yield and pump setting depth. Sufficient information about each element, including references and rationale for the planning and design decisions, should be collected, documented and discussed.

The pumping test plan you submit to DOH for review and approval can be simple or complex, depending on the project setting, size, and owner's resources. The development of a well represents a significant investment for a water system. Many elements of system design, including the number of customers that can connect to the water system and the design of the well pump are based on the expected yield of the source. The objective of the pumping test plan is to guide a well driller in establishing, with an appropriate level of confidence, the capacity of the aquifer and the pumping well to satisfy the minimum well yield expectations.

The proposed pumping well construction should be finalized prior to the pumping test plan. A pumping test should be designed to reflect the hydrogeology of the site, the hydraulic parameters to be determined, the defined test endpoints, and the degree of confidence. We provide a comprehensive outline for preparing a pumping test plan in the following sections.

3.1 Well Site Description

You should use existing data to develop a source area description:

- A map and description of the proposed well location, property ownership, topography, land use, known or potential sources of contamination in the vicinity (hazardous waste sites, sewer lines), and other pertinent related details. You should describe surface water bodies, including wetlands, irrigation channels, creeks, streams, rivers, lakes, ponds, estuaries, and coastal waters near the source area, as well as bedrock outcrops, faults and other potential boundaries.
- A table with information about wells located within ½ mile of the source (location, date installed, elevation, depth, casing length, screen interval, aquifer where the well is screened). If available, obtain copies of the well logs.
- Include vicinity, topographic, and other maps depicting the source area features and existing well locations with the source area description.

- Discussion on the aquifer conditions (confined, semi-confined, unconfined), thickness, lateral continuity, and special aquifer conditions as defined in Section 5.0
- Relevant aquifer or aquitard characteristics including soil or rock type; depth to, thickness, and areal extent of aquifer and aquitard units; known or suspected boundaries, water level data; type of aquifer (confined, leaky, unconfined), and hydraulic properties (hydraulic conductivity, transmissivity).
- Distance from the site to surface water bodies located (within one mile).

3.2 Well Construction and Condition

For a proposed well, include the following in a pumping test plan:

- Drilling method
- Ground surface elevation and method of determination
- Annular (surface) seal material, depth, and thickness
- Intended well diameter, depth, and casing
- Intended well screen type, screen interval(s), and length/depth

For an existing well, in addition to the items above, include the following:

- Well log
- Well development procedures
- Past pumping test results
- Past seasonal static water level and pumping level
- Documentation of problems with well performance
- History of well rehabilitation, cleaning, and redevelopment
- Present condition of casing, well screen, or perforations

3.3 Data

Provide test data reporting sheets, interval of data collection, means of collection (written or by automated data logger), who will be running the pump test/collecting data, and measuring device specifications, including:

- Clearly define the pumping test objective using definable endpoint(s) (e.g., demonstrate sustainable yield equals or exceeds 500 gpm/0.7 MGD and determine appropriate pump setting depth during crop irrigation season while S01 and S03 are pumping; based on a 24-hour constant-rate pump test).
- Identify and describe data gaps you will need to fill before and during the pumping test. (e.g., how will data collected during high groundwater conditions

inform the design so that the operational pumping rate and pump setting of the water source are suitable for the dry season?).

- Assess the confidence level obtainable with the proposed pumping test. Explain how the level of uncertainty effects the overall design of the water system. (*Will data collected provide a single source that will meet the desired demand or will storage capacity be required for the overall design?*).

3.4 Pumping Test Mechanics and Field Procedure

Describe water level and discharge measurement procedures, including measuring device(s), device calibration and accuracy, and the frequency of monitoring. We attached a template of the field data sheets to be used to the end of this appendix. Describe the capacity of the pump you will use in the pumping test and the rationale for selecting it. Provide a disposal plan for discharged water and potential impacts to the pumping test.

4.0 Recommended Pumping Test Methods and Procedures

The following components require consideration when designing a pumping test. We don't intend this information to be a resource for all aspects of pumping tests; it covers considerations necessary to collect useful, reliable data. You should conduct the pumping tests after full recovery from pumping that occurred before the start of the pumping tests. To reproduce the anticipated stress on the aquifer, the pumping test should take place when nearby wells are operating under normal conditions. Likewise, the pumping test plan should reflect multiple wells in a wellfield intended to be pumped simultaneously to meet the design source production.

No pumping should be conducted at or near the test site for at least 24 hours before the test. If on-site or nearby pumping cannot be curtailed due to system supply needs or other factors, you should note this and discuss it and how it relates to the test accuracy. If an interruption in the pumping test occurs, you need to demonstrate that the interruption had no significant effect on the data. If the interruption is longer than two hours, you should terminate the test, allow the water level to recover fully, and restart the test.

4.1 Stabilized Drawdown

Stabilized drawdown is when a water level has not fluctuated by more than plus or minus 0.5 foot for each 100 feet of water in the well (i.e., static water level to bottom of well) over the duration of constant flow rate of pumping. See Section 4.3.2 for guidance on the duration of a constant-rate pumping test under various aquifer conditions, and

guidance on the minimum duration of the stabilized drawdown phase the test. Plotted measurements of drawdown should also not show a trend of decreasing water levels.

Stabilized water level can often be misjudged due to varying hydrogeologic factors and the basis for stabilized water levels provided is the minimum required. Final judgement for stabilized drawdown ultimately rests with the hydrogeologist or engineer in charge of the pumping test.

4.2 Observation Wells

Observation wells provide more representative and accurate data during the pumping test. You should consider wells near the pumping well for observation well monitoring. Pretest analysis of well depth and distance can determine the best wells to use as observation wells. Observation wells with an open interval in the same aquifer as the test well are desired. If the aquifer you're evaluating is confined, it may be useful to select additional observation wells completed within the overlying or underlying aquifer to determine whether there is leakage into or from the confined water system.

For saltwater intrusion concerns, observation wells between the pumping well and saltwater body can provide the most useful information.

You should not use wells with floating food-grade lubricant or other product for pumping test evaluation, unless there is a shortage of observation wells at the site. The floating lubricant may introduce measurement errors and provide misleading results. If you use wells with floating food-grade lubricant, you should estimate the density of the product to calculate the equivalent head in the well.

4.3 Test Duration

The length of a pumping test depends on the purpose of the test and hydraulic properties of the aquifer. This guidance does not support the historical concept of a 4-hour pump test.

4.3.1 Step-Drawdown Test

The step-drawdown test procedure should consist of at least four constant-rate tests each run successively at increasingly higher flow rates until stabilized drawdown occurs. The well test begins at a low constant discharge rate until the drawdown in the well stabilizes, then the process is repeated at successively higher pumping rates through at least four steps. The duration of each step depends on achieving stabilized drawdown. Each step is typically of equal duration, lasting from about 30 minutes to 2 hours

(Kruseman and de Ridder 1994). It is important to run the initial step long enough to establish that the effects of well storage have dissipated.

4.3.2 Constant-Rate Test

The time required to run a constant-rate pumping test depends on the type of aquifer, distance to boundary conditions, and the level of accuracy needed to estimate hydraulic characteristics. A confined aquifer should be pumped a minimum of 24 hours while an unconfined aquifer should be pumped for a minimum of 72 hours. You also should do a pumping test of 72 hours or longer if pumping from aquifers with fracture flow, aquifers of limited areal extent, seawater intrusion, delayed yield or slow drainage effects.

You may need to extend the minimum pumping test duration if you anticipate that a delayed yield or slow drainage effect will influence the pumping test interpretation. While there are methods available to analyze fluctuating data, it is good practice to achieve stabilized water levels, especially when you need accurate information concerning aquifer characteristics. You should establish stabilized drawdown for a constant-rate test lasting at least 6 hours at the end of the minimum test duration. If stabilized drawdown is not achievable within a reasonable period, you should stop the test, allow the water level to recover to its original static water level, and conduct a new test at a lower pumping rate.

4.4 Pumping Rate

It is very important that the pumping rate be held constant during each phase of a pumping test. The pumping rate should be monitored to ensure the rate is maintained within 10 percent of its starting value. Fluctuations in pumping rate make the test analysis difficult and raise questions as to whether deviations in the data are actually a result of flow boundaries or other hydrogeologic features. Control of the pumping rate is often best accomplished by accurately measuring and controlling the discharge rate.

4.4.1 Step-Drawdown Test

Pumping rates used in a step-drawdown test should encompass the maximum design pumping rate for the well (Q_{max}) and be based on the pumping rate of nearby wells completed in the same aquifer or geologic unit.

Table 1 shows the recommended scheme for pumping rates in a step-drawdown test.

Table 1
Step-Drawdown Pumping Rates

Step	Rate
1	0.5 Q_{max}
2	0.75 Q_{max}
3	Q_{max}
4	1.25 Q_{max}

4.4.2 Constant-Rate Test

You should perform the constant-rate pumping test at or above the maximum design-pumping rate determined from the step-drawdown test results, and the rate sought for approval in the water-supply application.

4.5 Water-Level Measurements

Water-level measurements should be recorded to the nearest 0.01 foot. The well to be tested should be at its static water level prior to the test. Static water levels at the pumping well and observation wells should be measured at least daily for one week prior to the start of the test.

You also should make water level measurements of the pumping test at 24, 16, 12, 3, 2, and 1 hours prior to initiating pumping. Within the hour immediately preceding pumping, you should take water level measurements at 20-minute intervals to establish short-term trends in water level changes that may be occurring. Immediately before starting the pump, you should measure water levels in observation wells and in the pumped well to determine the static water levels upon which you will base drawdowns. These data and the time of measurement should be recorded.

The start of the pumping test should be recorded as time zero. It is important in the early part of the test to record with maximum accuracy the time at which readings are taken. You should follow the chosen time schedule as closely as possible. If the schedule is missed, you should record the actual time of a reading. Estimating drawdown readings to fit the schedule may lead to erroneous results. You do not need to take simultaneous readings in the pumping well and observation wells as long as you follow the schedule and record the exact time you take the readings.

You will make most of the measurements within the first 100 minutes when the water levels are changing rapidly. The time intervals given are suggested minimums; more frequent measurements can assist with pumping test analysis and interpretation. Due to the frequency of measurement required during the initial portion of the test, you should use electronic water level indicators marked in tenths and hundredths of a foot or data loggers. We recommend data loggers and pressure transducers, which provide efficiency and ease.

Barometric measurements of atmospheric pressure should be made at the same water level measurement intervals. These measurements will allow appropriate corrections to be applied to the drawdown data. In settings where tidal influences may affect the pumping test results, measurements should be made at a frequency sufficient to correct the pumping test drawdown data for observed tidal influences.

4.5.1 Step-Drawdown Test

Recording water levels during a step-drawdown pumping test should start for each change in rate. Table 2 provides a schedule appropriate for recording water levels during a step-drawdown test.

Table 2
Time Intervals for Measuring Water Level and Recording Data
Step-Drawdown Pumping Test

Time after the start of each step in the drawdown test and after pump shut off for recovery data	Time intervals to measure water levels and record data
0 to 10 minutes	0.5 minutes
10 to 15 minutes	1 minutes
15 to 30 minutes	2 minutes
30 to 60 minutes	5 minutes
60 to end of step*	10 minutes

*End of the step may be extended for a low-yield source

4.5.2 Constant-Rate Test

Before starting the constant-rate test, allow sufficient time for water levels to return to static conditions. As a general rule, the aquifer should be allowed to recover to within 95 percent of the static water level measured before the test. Adherence to the time schedule should not be at the expense of accuracy in the drawdown measurements. Table 3 provides a schedule appropriate for recording water levels during a constant-rate pumping test.

Table 3
Time Intervals for Measuring Water Levels
Constant-Rate Pumping Test

Time after pumping started for constant-rate test and after pump Shut off for recovery	Time intervals to measure water levels and record data	
	Pumping Well	Observation Well
0 to 10 minutes	0.5 minutes	2 minutes
10 to 15 minutes	1 minutes	
15 to 30 minutes	2 minutes	
30 to 60 minutes	5 minutes	
60 to 120 minutes	30 minutes	5 minutes
120 to 240 minutes		10 minutes
240 to 360 minutes		30 minutes
360 minutes to end of test	60 minutes	60 minutes

4.5.3 Recovery Data

When pumping stops water rises toward its pre-pumping level. The rate of recovery provides a means for calculating the coefficients of transmissivity and storage. In addition, the recovery phase is not subject to induced variations and can provide more reliable information. The time-recovery record, therefore, is an important part of an aquifer test.

Recovery measurements should begin immediately upon pump shut down and be collected using the same procedure and time pattern followed at the beginning of the pumping test. Recovery data should be recorded for at least 12 hours or until recovery to the static water level. Water level measurements should be made to the nearest 0.01 foot, and also be collected in all measured monitoring wells. A check valve should be used to prevent backflow of water in the riser pipe into the well, which could result in unreliable data.

4.6 Surface Water

Fluctuations in surface water stages (or stream flow) for all surface waters within 500 feet of the pumping well should be measured. Measurements should be made using, as appropriate: weirs, staff gages, piezometers, and so on. Weir flow measurements should be conducted for small streams. The horizontal distance between each observation point and the pumping well should be measured to the nearest foot. The vertical elevation of a fixed reference point on each observation point should be established to the nearest 0.01 foot and reported in NAVD 1988.

You should read and record measurements at least once daily for one week prior to the start of the test and at least twice per log cycle after the first 10 minutes for the duration of the test. Make measurements more frequently if surface water levels are changing rapidly.

4.7 Conveying Pumped Water

The design engineer should carefully review applicable requirements and permits for discharging pumping test water. You should dispose of the water being pumped from the well legally and follow the discharge practices allowed by local, state and federal regulations. Water discharged during the pumping test should be conducted away from the pumping well in a down gradient direction and at sufficient distance to eliminate recharge of this water to the aquifer.

The objective of conveying pumped water as far from the site as possible is to minimize the possibility of artificially recharging the aquifer and producing an erroneous pumping

test or affecting later stages of the test. There is no fixed rule on how far the water produced during the pumping test should be discharged from the vicinity of the well. It is best to pipe the water outside of the area the pumping test is likely to influence. Water conveyance is particularly important when conducting pumping tests in shallow unconfined aquifer settings. Considerations for determining a suitable distance include:

- If the aquifer is confined, less distance will be necessary.
- The shorter the duration of the pumping test, the less distance necessary.
- Depth to water and nature of geologic materials overlying the water producing materials:
 - The greater the depth to water, the less distance necessary.
 - The more transmissive the aquifer materials, the greater distance necessary.
- If possible do not discharge conveyed water between the test well and observation wells or suspected flow boundaries.

5.0 Concerns in Special Aquifer Settings

Reliability concerns have been identified for several aquifer settings, including water quality concerns and water quantity concerns. These aquifer settings do not require a different pumping test approach, but they do require longer tests, rigorous analysis of the test data, and additional pumping-test design details. Because of the greater difficulty and complexity in pumping test design and evaluation these settings present, we recommend that you consult with a licensed hydrogeologist. The design engineer also should contact the DOH regional engineer before developing the pumping test plan for special aquifer settings. We discuss elements and concerns unique to these conditions below.

5.1 Low-Flow Conditions

Low-flow conditions may be encountered in wells completed in aquifers with low transmissivity. In these situations, the ability of the aquifer to yield the required volume is of concern. Observation wells are not necessary because effects of pumping in low-flow conditions typically are not far reaching.

5.2 Fracture Flow

Typically, sources completed in bedrock or consolidated material may have fractured flow. The continuity of fractures can vary significantly within an aquifer and affect the aquifer's ability to provide water in a consistent manner. Restrictive conditions the pumping test identifies could include lack of stabilized drawdown, which could signify that recharge does not occur fast enough to maintain the desired pumping rate or the presence of multiple recharge boundaries.

It also is possible for the rate of drawdown to decrease with time. This effect would suggest that a recharge boundary was encountered. An extension of the pumping test duration and additional observation wells may be required to determine any effect the fracture flow has on long-term well yield. To obtain the appropriate data, you should carefully consider the goals of a bedrock source-pumping test and fracture density test before you plan the test duration and observation well network.

5.3 Aquifer of Limited Areal Extent

Aquifers of limited areal extent present concerns similar to fracture flow. Wells in this setting may provide a reliable source of water initially, but the limited areal extent and recharge capacity of these aquifers result in a reduced volume of water each day over the long term. The highly variable material that commonly make up these aquifers, can affect their ability to transmit water. The engineer should design the pumping test to identify recharge or impermeable boundaries. You should use observation wells, so you can determine the coefficient of storage as accurately as possible.

5.4 Seawater Intrusion

When water is pumped from an aquifer in a coastal area, the gradational boundary between seawater and freshwater will move in response to the pumping (Culhane, 1993). The location of the well, aquifer characteristics, and amount of the groundwater withdrawn effect the rate and extent of seawater movement. In addition to changing the lateral boundary between fresh and seawater, large withdrawals in individual wells can cause underlying seawater to migrate upward into the well, which is called “upconing” (Island County, 2005) (See Figure 1).

An assessment of inducing seawater into the pumping well or nearby wells is required. Engineers should design the pumping test to establish a rate that achieves stabilized drawdown without an associated increase in chloride levels in the pumping well or observation wells. We highly recommend at least one observation well, positioned between the pumping well and the shoreline, to assess seawater intrusion.

Water quality tests conducted during the pumping test in potential seawater intrusion areas differ from the other aquifer settings primarily in that chloride, total hardness (as CaCO_3), and specific conductivity are monitored in both the pumped wells and observation wells. You don't need to outline specific sampling intervals in the pumping test design. Seawater is

Figure 1
Seawater Upconing

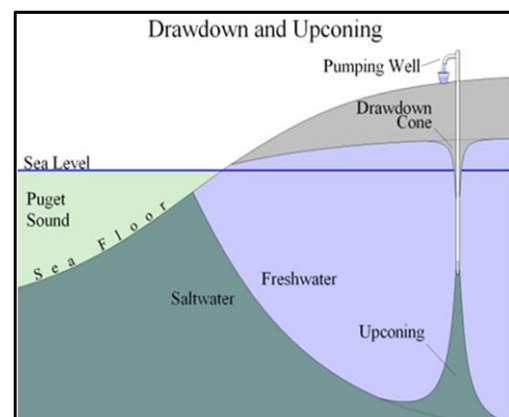

not the only potential source of chloride in groundwater (Culhane, 1993). Highly mineralized groundwater (hard water) can contain high levels of chloride. Other possible sources of chloride include septic tank effluent, windblown sea spray, agricultural practices, irrigation recharge, and well disinfection. Testing for hardness will help determine whether elevated chloride concentrations resulted from hard water or possible seawater intrusion.

You can use instruments or test kits specific to these parameters to monitor water quality indicators in the field. Water quality measurements are used to determine whether concentrations are increasing, potentially signifying that saltwater is being drawn towards the pumping well. Field tests are good screening tools but DOH recommends submitting some samples to an analytical laboratory to verify the field test results. After putting the well into full-time use, continue to monitor for chloride, total hardness, and specific conductivity to identify trends and maintain potability. You need to evaluate tidal influences before conducting the pumping test to determine whether you need to adjust the drawdown data (Kruseman and de Ridder, 1991).

5.5 Multiple Wells and Well Fields

This setting refers to two or more wells completed in the same aquifer. They may be pumped alternately or concurrently. DOH's primary concern in this setting is whether the new well interferes with other wells or with aquifer recovery.

If a pumping test was done for an existing well and data was collected from an observation well(s), you can determine the potential for well interference due to adding another well by using a distance-drawdown graph and evaluating additive drawdown for the pumping wells. This is based on the principle of superposition, where the drawdown at any point in the area of interference caused by the discharge of several wells is equal to the sum of the drawdowns caused by each individual well.

If an applicant is seeking approval for multiple production wells, the engineer should monitor all wells during the test. In addition, the test should be conducted in a way that will obtain information pertinent to the operational needs of the wellfield. Pumping test design should reflect intended operating conditions of all wells. Conducting an additional pumping test exclusively on the new well would provide little new information beyond validating the findings of the initial pumping test. In general, an evaluation of potential well interference for either cyclical or concurrent pumping can be determined using the additive drawdown approach. If an observation well was not used during the pumping test, the same approach can be used. However, the results will likely be less accurate in predicting well interference.

DOH considers each source approval in a multiple well setting on a well-by-well basis. The water system should contact DOH to discuss a pumping test approach before conducting the test.

5.6 Groundwater Wells Potentially Under the Direct Influence of Surface Water

Wells identified as potentially under the direct influence of surface water, may need a pumping test to determine whether a hydraulic connection exists with nearby surface water. A pumping test may be conducted to supplement water quality data and/or an MPA test. Design engineers should use the pumping test evaluation to delineate the well capture zone and estimate the time of travel under various pumping and water level conditions. They will need to adjust the pumping test duration to evaluate hydraulic connectivity.

6.0 Pumping Test Results

To analyze pumping test data accurately, you need to use methods and formulae appropriate for the hydrogeologic and test conditions encountered at, and specific to, the pumping test site. You must know the hydrogeologic conditions in the area to ensure you use appropriate analysis techniques. Numerous texts cover the analysis and evaluation of pumping test data (USEPA, 1993; Kruseman and de Ridder, 1991; Walton, 1970; and Ferris, Knowles, Brown, and Stallman, 1962).

6.1 Pumping Rate Determination

You can select the pumping rate for a well from the step-drawdown test. Calculate the well efficiency, and then plot the well efficiency versus the corresponding pumping rate, to create a sustainable well-yield graph. Well efficiency is defined as the ratio of the theoretical drawdown in the formation to the actual drawdown in the well. By selecting a pumping rate that corresponds to the desired well efficiency, you can identify a sustainable well yield. See Figure 2 for an example of the plot. A well efficiency of 70 percent or more is usually desirable for a sustainable pumping rate.

A specific capacity plot of drawdown versus yield may also be used to show a point that defines a sustainable well yield. By plotting well yield versus drawdown, you can create a specific capacity curve. On this curve, you can identify deviations from a linear response and note the approximate point of departure selected as a sustainable well yield.

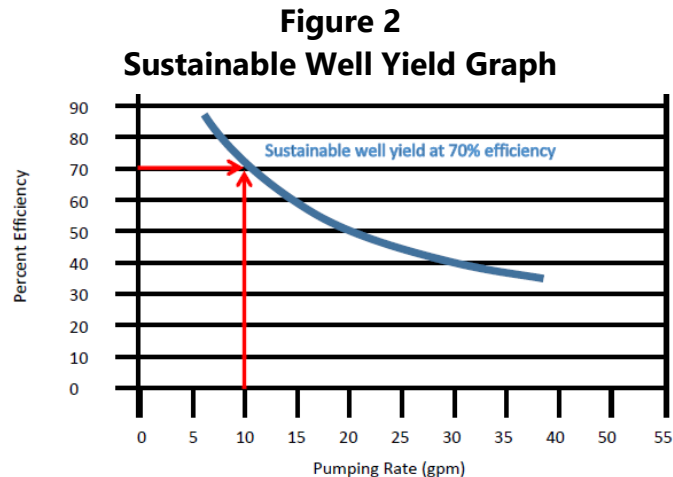

6.2 Pump Setting

Pump and well characteristics determine the pump setting. Specific capacity plots combined with constant-rate test data can identify correct pump settings by correlating points on the plots where stabilized drawdown occurs. The drawdown depth determined from this correlation, incorporation of a safety factor, and the distance the design engineer chooses to place the pump intake below the pumping level, will define the pump setting.

6.3 Safety Factor

There are no rules for determining a safety margin. But, it is a good idea to incorporate a safety margin for long-term operational considerations. Failure to make these provisions may require a change in pump design or setting the pump deeper into the well at a future date. A safety factor helps account for inaccuracies in the pumping test, potential effects from boundary conditions, seasonal water level fluctuations, or other special aquifer settings. These inaccuracies usually arise because of lack of complete information about the overall aquifer characteristics or changes that may occur over time.

7.0 Reporting

A hydrogeologic report summarizing current hydrogeologic data and pumping test data is required. The person preparing the report should use the elements of the planning and design stage. It should:

- Summarize the pumping test.

- Contain the specific capacity, maximum production rate, and estimated aquifer properties. The summary will need to substantiate these values by presenting the worksheets, graphs and calculations.
- Discuss interpretations made about the aquifer at the site, including confining conditions and boundary conditions observed during the course of the test.
- Reconcile observed drawdown characteristics with the hydrogeologic setting, and explain why the analysis technique chosen (curve-fitting or numerical modeling) is appropriate.

All calculations and data analyses should accompany the final report. You should submit all raw data in tabular form along with the analysis and computations. All calculations should clearly show the data used for input, the equations used, and the results achieved. Note any assumptions made as part of the analysis in the calculation section (EPA, 1993).

7.1 Pumping Test Data Presentation

The water-level data presentation should include a graph of the arithmetic water-level elevation versus time for the data from each well. From these graphs, you can discuss long- and short-term trends, recovery of water levels, and evidence of aquifer boundaries. You should address incomplete recovery and deviations from the theoretical recovery trends, if appropriate.

You should present graphs of drawdown, versus time and distance, versus drawdown, on semi-log or log-log paper. You should:

- Correct water level data, graphs, and interpretations, as appropriate.
- Present the effects of ambient water level trends, partially penetrating production well(s), partially penetrating observation wells, delayed yield from well storage and unconfined aquifers, aquifer thickness, recharge, or impermeable boundaries, and barometric pressure changes.
- Stage changes in nearby surface water bodies, recharge events (rainfall, snow melt) during the week preceding the test, during the test, or during the recovery period, influence from nearby pumping wells, and other hydrogeologic influences.

Use the recorded time and the corresponding drawdown to prepare time drawdown graphs. The graphs should be constructed on a semi-logarithmic scale with time plotted on the log scale. The plotted points will form a straight line after a certain pumping time and the slope of that line will estimate the transmissivity of the aquifer. Changes in the slope of the line may indicate boundary conditions.

Theoretical distance-drawdown graphs should be prepared by plotting the drawdown in each observation well versus the distance of those wells from the pumping well. The graphs should set time equal to the length of the pumping test and groundwater withdrawal equal to the pumping test production rate. Storativity values can be determined from the distance-drawdown graph. Recovery data should be analyzed in a similar manner to drawdown data.

8.0 Potable-Water Supply Samples

Samples should be taken at a time representative of aquifer water quality. Ideally, you should take samples within the last 15 minutes of the constant-rate pumping test. Water samples **must** be collected from the source using proper sampling procedures and be analyzed by an accredited laboratory (WAC 246-290-130(3)(g)). DOH will determine source-monitoring requirements prior to the pumping test. Table 4 shows the minimum water quality parameters required for a source approval.

Table 4
Minimum Water Quality Sampling for Source Approval¹

Community	Nontransient Noncommunity	Transient Noncommunity
Coliform Bacteria	Coliform Bacteria	Coliform Bacteria
Inorganic Chemicals	Inorganic Chemicals	Inorganic Chemicals
Volatile Organic Chemicals	Volatile Organic Chemicals	Volatile Organic Chemicals
Synthetic Organic Chemicals ¹	Synthetic Organic Chemicals ²	
Radionuclides		

Notes:

¹ When we published this manual, DOH considered adding a new contaminant standard known as a state action level (SAL). If we adopt a SAL for a previously unregulated contaminant, we will require you to sample some or all new sources for that contaminant at the time of source approval.

² Synthetic organic chemicals (SOCs) unless the source qualifies for a waiver that exempts it from of all or a partial list of SOCs.

References

- Culhane, T. 1993. *High Chloride Concentrations in Ground Water Withdrawn from Above Sea Level Aquifers, Whidbey Island, Washington*. OFTR 93-07. Washington State Department of Ecology, Olympia, WA.
- Ferris, J. G., D. B. Knowles, R. H. Brown and R. W. Stallman. 1962. *Theory of Aquifer Test*. U.S. Geological Survey Water Supply Paper 1536-E, pp 69-174.
- Island County. 2005. *Seawater Intrusion Topic Paper*. Island County Water Resources Management Plan. Island County, Coupeville, WA.
- Kruseman, G.P. and N.A. de Ridder. 1994. *Analysis and Evaluation of Pumping Test Data (2nd ed.)*, Publication 47, Intern. Inst. for Land Reclamation and Improvement, Wageningen, The Netherlands, 370p.
- USEPA. 1993. *Suggested operating procedures for aquifer pumping tests (EPA/540/S-93/503)*, Robert S. Kerr Environmental Research Laboratory, Ada, Oklahoma, 23p.
- Walton, W.C. 1970. *Groundwater Resource Evaluation*, McGraw-Hill, New York, 664p.

Pumping Test Forms

Measurements for elevation and depth to water should be to the nearest ± 0.01 foot.

Owner name: _____

Mailing address: _____ City _____ County _____ Zip _____

Well Location: Address (cross streets ok): _____ City _____ County _____ Zip _____

or Legal description: Sec. _____ in the _____ 1/4 of _____ 1/4 Twp. _____ Rg. _____ E or W _____

Description of well location (attach sketch, if nec.): _____

NAD 83: Zone: _____ and UTM Easting: _____ ft or Latitude: deg: _____ min: _____ sec: _____
 (Datum must be set to NAD83) UTM Northing: _____ ft Longitude: deg: _____ min: _____ sec: _____

Ground elevation: _____ (ft) amsl Method: GPS Level survey Other (specify): _____

Class of well: Group A Tax Parcel Number: _____
 Group B

Pumping Test Summary Information

Type of well pump:

- Submersible Jet (end-suction)
 Vertical turbine Other (specify) _____

Depth of pump setting: _____ ft (btoc)

Type of Pumping Test:

- Constant Rate Step Test Other (specify) _____

Method of water level measurement:

- Water level sounder Data logger Air line
 Wetted tape Other (specify) _____

Reference datum for water level measurements:

- Top of casing Ground level Other (specify) _____

Final stick-up _____ ft ± 0.01 foot

Method of flow measurement:

- Flow meter Orifice 45-gallon drum
 5-gallon pail Other (specify) _____

Start date of pumping test: _____ (MM/DD/YYYY)

Static water level: _____ ft

Duration of pumping: _____ hrs

Duration of recovery: _____ hrs

Well yield estimated from pumping test: _____ gpm

Available drawdown: _____ ft

Specific Capacity: _____ gpm/ft

Method of estimating long-term well yield from pumping test: _____

Pumping test data sheet(s) attached:

Person conducting the pumping test (please print):

Name (first, last): _____

Company name: _____

Phone No. _____

Registration number of person responsible*: _____

Consultant (if applicable; please print): _____

* Fill in the registration of the Qualified Well Driller/Pump Installer. If the test was conducted by a driller/pump installer who is not registered, the Qualified Well Driller/Pump Installer who is directly supervising the work should fill in their registration number.

Declaration:

The pumping test has been done in accordance with the requirements in the Water System Design Manual Appendix E (Pub DOH 331-123) or the Group B water System Design Guidelines Appendix F (Pub DOH 331-467).

PLEASE NOTE: The data recorded in this pumping test report reflect conditions at the time of the test. Water levels, well performance, estimated long-term well yield and water quality are not guaranteed as they are influenced by a number of factors, including natural variability, human activities, and condition of the works, which may change over time.

Signature of Person Responsible: _____

Return Completed Report, Data Sheets and Data Plots to:
 Department of Health Office of Drinking Water Regional Office

Table 1: Definitions of Abbreviations

amsl above mean sea level	gpm.....gallons per minute	Rg.Range
btocbelow top of casing	ininches	sec.seconds
degdegrees	no.number	Sec.Section
ftfeet	deg.....degrees	Twp.Township
hhhour	minminutes	UTMUniversal Transverse Mercator Grid
hrs.....hours	mm.....minute	NAD 83.....North American 1983 datum
Temp.....temperature	Cond.....Conductivity	

Table 2: Recommended Minimum Frequency for Water Level Measurements for Pumping Tests

The recommended minimum frequency for water level measurements during pumping and during recovery is shown below:

Step-Drawdown Test

Time After Pumping Started For Each Step-drawdown Test And After Pump Shut Off For Recovery	Time Intervals To Measure Water Levels And Record Data
0 to 10 minutes	0.5 minute
10 to 15 minutes	1 minutes
15 to 30 minutes	2 minutes
30 to 60 minutes	5 minutes
60 to end of step	10 minutes

Constant-Rate Test

Time After Pumping Started For Constant Rate Test And After Pump Shut Off For Recovery	Time Intervals To Measure Water Levels And Record Data	
	Pumping Well	Observation Well
0 to 10 minutes	0.5 minute	2 minutes
10 to 15 minutes	1 minutes	
15 to 30 minutes	2 minutes	
30 to 60 minutes	5 minutes	
60 to 120 minutes	30 minutes	5 minutes
120 to 240 minutes		10 minutes
240 to 360 minutes		30 minutes
360 minutes to end of test	60 minutes	60 minutes

Office of Drinking Water Regional Contacts

Regional engineer assignments are subject to change. Contact the appropriate regional office for the name of the engineer assigned to your county. This information can be found online at <https://www.doh.wa.gov/CommunityandEnvironment/DrinkingWater/OfficesandStaff>

Appendix F: Submittal Outlines for Select Water Treatment Processes

- Appendix F.1 Hypochlorination Facilities for Small Water Systems Using Groundwater or Seawater**
- Appendix F.2 Fluoride Saturator (Upflow Type)**
- Appendix F.3 Arsenic Removal by Coagulation/Filtration**
- Appendix F.4 Arsenic Removal by Adsorbents**
- Appendix F.5 Use of Ozone in Groundwater Treatment**
- Appendix F.6 Reverse Osmosis for Desalination of Seawater or Brackish/Estuarine Surface Water**
- Appendix F.7 Rainfall Catchment Submittal Requirements**
- Appendix F.8 Rainfall Catchment Reliability Analysis - Example**
- Appendix F.9 Iron and Manganese Treatment by Oxidation-Filtration**
- Appendix F.10 Iron and Manganese Treatment by Sequestration**
- Appendix F.11 Nitrate Removal by Ion Exchange**

Appendix F does not address all water treatment processes. For general water treatment guidance, see Chapter 10 and Appendix A.3.8.

Appendix F.1 Hypochlorination for Small Water Systems

Submittal Outline

This outline will guide and summarize your hypochlorination treatment facilities' design for small water systems using groundwater or seawater sources treated by reverse osmosis.

An engineer licensed in Washington state must prepare submittals for water treatment facilities. You **must** include all supporting documentation with the design submittal (WAC 246-290-110).

F.1.1 General Water System Information

Provide the following information:

- A. Water system name and public water system identification number.
- B. Owner's name, address, and telephone number.
- C. Manager's name, address, and telephone number.
- D. Operator's name, certification level, and telephone number.
- E. Completed (preliminary) [Purification Plant Criteria Worksheet](#). (include all existing and proposed treatment processes)
- F. Completed [Project Approval Application Form](#) (DOH 331-149-F).

F.1.2 Description of the Water Quality Problem

Describe the source of supply and the purpose and goals of the proposed treatment. For example, is groundwater treatment required to address criteria because of any of the following?

- A. WAC 246-290-453(1): Required 4-log virus inactivation due to fecal indicator in source water.
- B. WAC 246-290-451(4): Required CT6 due to coliform present in source water, microbial contaminant sources within the sanitary control area, groundwater in hydraulic connection with surface water, and seawater treated by reverse osmosis.
- C. WAC 246-290-451(5): Required free chlorine residual throughout the distribution system.
- D. Other treatment objectives: Fe/Mn oxidation/filtration, arsenic oxidation, hydrogen sulfide oxidation, and so forth.

F.1.3 Raw Water Quality

Groundwater quality tends to vary less than surface water quality, but some groundwater parameters can substantially change seasonally. If an *E. coli* MCL violation or Ground Water Rule-triggered *E. coli* source detection is driving the disinfection system design, then the priority is to complete the design and construction as soon as possible. Under these circumstances, you should collect one set of water quality parameter samples (see following table) in support of the design.

With sufficient time, the design engineer should use water quality information collected from both the dry season and from the onset of the wet season before completing the design. Two separate measurements should be performed for the parameters listed below.

A qualified person with properly calibrated instruments must measure temperature and pH at the well site (not in a lab). A laboratory certified for drinking water must analyze all other water quality parameters. Submit all lab data sheets to DOH.

Seawater RO product water is of high quality and consistent with very low chlorine demand. Hypochlorination facilities designed for seawater RO systems do not need to sample for the parameters listed below.

Raw Water Quality Table

Water Quality Parameters	Comment
Total Ammonia-Nitrogen (mg/L)	1 mg/L Ammonia-Nitrogen will react with 8-10 mg/L of chlorine.
Dissolved organic carbon (DOC) (mg/L)	DOC is a precursor to the formation of disinfection byproducts and exerts a chlorine demand. We found values less than 1.0 mg/l DOC unlikely to result in exceedances of the TTHM MCL, and values less than 2.0 mg/L DOC unlikely to result in exceedances of the HAA5 MCL. DOC levels can vary seasonally in some groundwater sources. DOH recommends seasonal testing.
Iron (mg/L)	Iron has a secondary MCL of 0.30 mg/L. In addition, 1 mg/L of reduced iron (Fe^{+2}) exerts 0.6 mg/L of free chlorine demand
Manganese (mg/L)	Manganese has a secondary MCL of 0.050 mg/L. In addition, 1 mg/L of reduced manganese (Mn^{+2}) will react with 1.3 mg/L free chlorine

Coliform bacteria	Note the date of any total coliform or <i>E. coli</i> detections in the groundwater source over the previous 12 months.
Bromide (mg/L)	Only applies to coastal groundwater sources.
Chloride (mg/L)	
pH	Applies when free chlorine used to achieve 4-log virus inactivation. A qualified person with properly calibrated instruments must measure temperature and pH at the well site (not in a lab). Temperature should be measured during winter.
Temperature	

Secondary Water Quality Effects

Introducing chlorine into a previously unchlorinated system can cause:

- Release of accumulated metals and sediments in the distribution system
- Formation of disinfection byproducts
- Taste and odor concerns

For these reasons, additional water quality analysis should be conducted. The additional analysis will vary from system to system and could include:

- Oxidation-reduction potential (ORP) of untreated and chlorinated water
- Disinfection byproduct formation potential

In some cases, destabilization and dissolution of accumulated iron, manganese, arsenic, and other metals may create unwanted aesthetics or unsafe drinking water. Engineers and water system staff can evaluate the potential for metal release using a variety of methods ranging from simple desktop studies to pipe-loop studies using sections of water main pulled from the distribution system.

Design engineers must assess how the hypochlorite addition affects the potential for corrosion and submit it to DOH (see Section 10.1.3). We will require systems of all sizes that install sodium hypochlorite for the first time to complete one round of annual lead and copper tap monitoring as soon as possible within the June to September monitoring period following installation. If the design engineer's corrosion assessment demonstrates hypochlorite addition will have minimal effect on corrosion, and DOH agrees, then DOH may not require this special round of annual tap monitoring.

Small systems (population <3,300) may forego a corrosion assessment and simply opt for the annual set of samples. Medium and large systems may not opt out of the corrosion assessment requirement by simply agreeing to collect one round of annual monitoring after installing and beginning to operate sodium hypochlorite treatment.

F.1.4 Hypochlorination System Details

Provide a written description of the hypochlorination treatment operational requirements. Include:

- A. Injection point.
- B. Maximum system pressure at chlorine injection point.
- C. Peak hour demand (Q_{PHD})
- D. Average daily water use, gallons/day (Q_{ADD}).
- E. Maximum daily water use, gallons/day (Q_{MDD}).
- F. Design flow rate of water to be treated at injection point gpm (Q_s), and whether the flow rate at the injection point is constant (for example, Q_s = installed single speed well pump discharge) or variable (for example, VFD booster pump discharge).
- G. Target free-chlorine residual, mg/L (C_t). If the treatment objective is to provide 4-log virus inactivation, C_t is directly related to available contact time (T). See *Contact Time* discussion below. If the treatment objective is to maintain a free-chlorine residual throughout the distribution system, consider the residence time in the downstream storage and distribution system, to the last customer.
- H. Estimated chlorine demand (due to ammonia, organics, iron and manganese, or other inorganics), mg/L (C_d).
- I. Describe how you estimated chlorine demand.
- J. Describe disinfection byproduct formation potential
- K. Calculate required chlorine dose, mg/L ($C_s = C_t + C_d$)

F.1.5 Hypochlorination Feed Pump Requirements

This section is devoted to determining feed pump requirements. DOH recommends that water systems purchase a spare feed pump, so that it's available for immediate installation and use when the operating pump undergoes routine maintenance or fails.

- A. Identify sodium hypochlorite stock chlorine strength, in percent available chlorine (e.g., 8.25%) (C_c). If the source of hypochlorite is calcium hypochlorite, the following equations do not apply. Calcium hypochlorite is typically identified as available chlorine in percentage (e.g., 65% available chlorine). See notes below.
- B. Amount of stock chlorine to be added to solution tank, in cups (V_c)

- C. Volume of feed solution, in gallons (V_f). V_f is the sum of the stock chlorine volume and the volume of added dilution water.
- D. Concentration of feed solution, mg/L (C_f)

$$C_f = \left(\frac{(C_c)(V_c)(10,000)}{(V_f)(16)} \right)$$

- E. Required feed pump rate, gallons/hour (Q_f)

$$Q_f = \frac{(Q_s)(C_s)(60)}{C_f}$$

Q_f = Capacity of chemical feed system, gph

Q_s = Maximum system flow rate, gpm

C_s = Desired free chlorine dose, mg/L

C_f = Concentration of feed solution, mg/L

Calcium hypochlorite [$\text{Ca}(\text{OCl})_2$] disinfection systems create a hypochlorite solution by dissolving [$\text{Ca}(\text{OCl})_2$] into water. One pound of 65% [$\text{Ca}(\text{OCl})_2$] provides 0.65 lbs. of available chlorine. If dissolved into 25 gallons of water (about 210 lbs. of water), 1 lbs. of [$\text{Ca}(\text{OCl})_2$] will produce a solution strength of 0.003 lbs. available Cl_2 per lbs. of water; equal to $C_f = 3100$ mg/L.

F.1.6 Hypochlorination Feed Pump Specifications

Describe the make and model of the hypochlorination feed pump(s), and confirm that the selected pump will perform under the range of operating conditions.

- A. Identify pump make and model.
- B. Identify the pump's discharge pressure range, and confirm that the maximum pressure capacity of the pump is compatible with the maximum discharge pressure at injection.
- C. Identify the pump's volumetric discharge range, and confirm that the maximum and minimum capacities are compatible with the maximum and minimum range of flow to be treated at the point of injection.
- D. Confirm wetted parts are compatible with chemical solution being pumped.
- E. Identify the need for a hypochlorination pump discharge flow modulation. Discharge flow modulation is needed if the flow at the point of injection is variable.

F.1.7 Solution Tank Sizing

Identify the size of the hypochlorite solution tank.

$$RT = \left(\frac{(V_t)(Q_s)(60)}{(Q_f)(Q_{PROD})} \right)$$

RT = Estimated time between tank refills, days

V_t = Size of solution tank, gallons

Q_{PROD} = Expected daily source production, gallons per day

F.1.8 Achieving 4-log Virus Inactivation (CT6) Treatment

Unanticipated environmental conditions, or other factors beyond the water system's control, may adversely affect source water quality at any time. DOH strongly recommends that all water systems planning disinfection include dedicated contact-time facilities capable of achieving 4-log virus inactivation, or CT6 disinfection treatment, as part of the design—even if the source is currently free of contamination.

- A. Dedicated contact time in this context means contact piping (most preferred) and/or contact storage (less preferred) that is solely dedicated to providing disinfection contact time for the disinfected source, and is not nested in a larger storage tank that is providing operational, standby, or equalizing storage.
- B. 4-log virus inactivation treatment triggers are summarized in WAC 246-290-453.
- C. CT6 treatment triggers are summarized in WAC 246-290-451.

A water system with a groundwater or seawater RO source requiring 4-log virus inactivation or CT6 disinfection treatment before the first customer, may achieve this level of inactivation using free chlorine by providing a minimum CT value of 6 if pH is in the range of 6–9 and water temperature is greater than or equal to 10°C. Groundwater supplies with measured temperatures below 10°C or above pH 9 require a CT value greater than 6. See Sections 10.2.1 for guidance.

Provide the following information:

- A. Available minimum contact volume (excluding operational, standby, and equalizing storage), gallons (V)
- B. Baffling factor (BF). Use 0.1 for an unbaffled chlorine contact tank with separate inlet and outlet, where tank volume is equal to the lowest daily value. For chlorine contact piping, a length-to-diameter ratio of at least 160 is needed to achieve a baffling efficiency of 1.0 if the flow through the pipe is turbulent and not laminar. A length-to-diameter ratio of at least 40 is needed to achieve a baffling factor of 0.7. For shorter pipe segments, the baffling factor can be estimated using the

length-to-width ratio and information in *Improving Clearwell Design for CT Compliance* (Crozes et al. 1999). The engineer should assess contact piping comprised of different diameters for total contact time as the sum of separate in-line sequences. Parallel contact pipes must each be adequate to provide a CT value of 6 or greater for the design flow through each pathway. Include elbows in pipeline length.

- C. Credited contact time, minutes (T_{credited}).
- D. Maximum anticipated flow out of the chlorine contact tank and/or through the pipeline to the first customer, gpm (Q).

$$T_{\text{credited}} = BF \left(\frac{V}{Q} \right)$$

The free chlorine concentration at the end of "T" must provide for the minimum required CT value.

F.1.9 Checklist of Additional Items

- A. Plans showing size and location of:
 - i. Sampling taps for both raw and treated water.
 - ii. Sampling tap following contact time piping or storage.
 - iii. Entry to distribution system sampling location.
 - iv. Flow meter on the outlet of the tank used for contact time to measure Q when satisfying CT6 or 4-log virus inactivation requirements.
 - v. Flow meter on the outlet of the contact piping used for contact time to measure Q unless the source meter will measure the same total and instantaneous rate of flow.
 - vi. All existing and proposed raw and treated water piping, existing treatment (if any), valves, appurtenances, equipment controls and monitoring devices, supports, and cross-connection control devices/assemblies.
- B. Manufacturer's specifications for:
 - i. Chemical feed pump.
 - ii. Variable feed pump output control system (if applicable).
- C. Solution tank with calibrated volume.
- D. Flow meter(s).
- E. DPD chlorine test kit (see WAC 246-290-451 and -453 for allowable test methods). DOH recommends using only a digital colorimetric testing device employing an EPA-approved analytical method.

- F. Systems serving more than 3,300 people with a 4-log virus inactivation requirement **must** have a continuous chlorine residual analyzer at the location for measuring "C" (WAC 246-290-453).
- G. Source of hypochlorite listed under NSF 60 (drinking water additives), except as allowed under WAC 246-290-220.
- H. Identify the appropriate DOH monthly treatment plant report form. See [groundwater disinfection report forms](#) online.
- I. Operations and maintenance plan. Confirm that the certified operator reviewed and had the opportunity for input on the design and O&M plan.
- J. Disinfection byproducts monitoring plan (not applicable to transient noncommunity systems).
- K. Updated coliform monitoring plan.

Appendix F.2 Fluoride Saturator, Upflow Type

Submittal Outline

This outline will guide and summarize your fluoride treatment design using an upflow sodium fluoride (NaF) saturator.

An engineer licensed in Washington state must prepare submittals for water treatment facilities. You **must** include all supporting documentation with the design submittal (WAC 246-290-110).

F.2.1 General Water System Information

Provide the following general information:

- A. Water system name and public water system identification number.
- B. Owner's name, address, and telephone number.
- C. Manager's name, address, and telephone number.
- D. Operator's name, certification level, and telephone number.
- E. Completed (preliminary) [Purification Plant Criteria Worksheet](#) (include all existing and proposed treatment processes).
- F. Completed [Project Approval Application Form](#) (DOH 331-149-F).

F.2.2 Description of the Treatment Objective

Describe the source of supply and the purpose and goals of the proposed treatment. The treatment objective should be consistency of fluoride concentration at all times throughout all portions of the distribution system. The optimal treated water fluoride concentration is 0.7 mg/L. Water systems that fluoridate **must** maintain a fluoride concentration between 0.5 mg/L and 0.9 mg/L in the distribution system (WAC 246-290-460).

F.2.3 Fluoridation System Details

- A. Provide a written description of the fluoridation treatment operational requirements. Include:
 - i. Source type (surface, groundwater, purchased). Naturally occurring fluoride concentration in surface water may be more variable than groundwater, demanding more design data and the capacity to recognize changes in natural fluoride concentration in source water.
 - ii. Natural fluoride concentration in source water, mg/L (C_n). Provide natural fluoride source water quality data from the last 10 years if available.
 - iii. Injection point.

- iv. Maximum and minimum system pressure at fluoride injection point, to establish chemical feed pump specification and needed backflow/overfeed protection.
 - v. Population served (direct customers and any customers served by consecutive systems).
 - vi. Average, maximum, and minimum daily source production, gallons/day.
 - vii. Design flow rate of water to be treated at injection point gpm (Q_s), and whether the flow rate at the injection point is constant or variable.
 - viii. Target fluoride residual, mg/L (C_t).
 - ix. Required fluoride dose, mg/L ($C_s = C_t - C_n$)
 - x. Calculated fluoride feed rate at average, maximum, and minimum source production rate. The maximum pump capacity of the chemical feed pump should be no more than twice the chemical feed pumping rate during average source production.
- B. Water softening:
- i. DOH recommends that water used in saturator first undergo softening if total hardness is greater than 75 mg/L as CaCO_3 .
 - ii. Water softener regeneration frequency and salt requirement per regeneration. Operators should strive to maintain at least a 30-day supply of salt.

F.2.4 Fluoridation Feed Pump Requirements

This section is devoted to determining the NaF feed pump requirements. We recommend that water systems purchase a spare feed pump, so it's available for immediate installation and use when the operating pump undergoes routine maintenance or fails.

$$Q_f = \frac{(Q_s)(C_s)(60)}{C_f}$$

Q_f = Capacity of chemical feed system, gph

Q_s = Maximum system flow rate, gpm

C_s = Desired fluoride dose, mg/L

C_f = Fluoride concentration in a saturated solution, mg/L (based on NaF supplier)

F.2.5 Fluoridation Feed Pump Specifications

Describe the make and model of the fluoridation feed pump(s), and confirm that the selected pump will perform under the range of operating conditions.

- A. Identify pump type (diaphragm, peristaltic), make and model.
- B. Identify the pump's discharge pressure range, and confirm that the maximum pressure capacity of the pump is compatible with the maximum discharge pressure at the point of injection.
- C. Identify the pump's volumetric discharge range, and confirm that the maximum and minimum capacities are compatible with the maximum and minimum range of flow to be treated at the point of injection.
- D. Confirm wetted parts are compatible with chemical solution being pumped.
- E. Identify the need for a fluoridation pump discharge flow modulation. Discharge flow modulation is needed if the flow at the point of injection is variable.
- F. Identify need for an in-line mixer. If the distance from the point of injection to the first service tap is less than 100 feet, an in-line mixer should be included in the design.
- G. Feed pump power cord should be specified with a nonstandard outlet plug and outlet receptor, or hard-wired to the source pump interlock.

F.2.6 Solution Tank Sizing

DOH recommends that the design include a clear solution tank filled manually each day from the fluoride saturator. We recommend a maximum 1.25 days (30 hours) of capacity in the fluoride solution tank. Limit the transfer rate from saturator to clear solution tank to 2 gallons per minute.

Identify the size of the fluoride clear solution tank.

$$RT = \left(\frac{(V_t)(Q_s)(60)}{(Q_f)(Q_{PROD})} \right)$$

RT = Estimated time between tank refills, days

V_t = Size of solution tank, gallons

Q_{PROD} = Expected daily source production, gallons per day

F.2.7 Make-up Water Supply and Cross-Connection Control

Describe the make-up water supply and cross connection-control measures:

- A. Water supply

- i. Pipe size, inches
 - ii. Pipe material
 - iii. Static pressure, psi
 - iv. Flow restrictor capacity (2 gpm)
- B. Backflow protection. An RPBA is required on the saturator make-up water supply line. See WAC 246-290-490 for cross-connection control requirements.

F.2.8 Overfeed Protection

Improper controls on fluoride treatment may lead to an increased risk of fluoride overfeed. The following measures are intended to reduce the risk of overfeed, and should be addressed in the design of any fluoride treatment system (WAC 246-290-110):

- A. Fluoride feed pump electrically interconnected with source pump.
- B. Flow sensing switch in water main interconnected with fluoride feed pump.
- C. Antisiphon valve at pump head (not needed if fluoride feed pump is peristaltic type).
- D. Antisiphon valve at injection quill.

F.2.9 Checklist of Additional Items

- A. Sample tap for raw and treated water (following mixing).
- B. Source meter to record total volume pumped.
- C. Make-up meter to record total solution volume fed.
- D. Flow proportioned feed pump (if applicable).
- E. Nonstandard feed pump plug and outlet, or hardwired to the source pump interlock.
- F. ANSI/NSF 60 certification for NaF chemical.
- G. Dry storage for 30-day supply of chemical.
- H. Materials Data Safety Sheet (MSDS) information posted where the chemical is stored and used, and/or available where all other MSDS information is kept in the treatment location.
- I. Provide respirator, gloves, apron, and goggles for handling NaF.
- J. Fluoride test kit (SPADNS or ISE with ionic strength adjustment) in specifications.
- K. Provide DOH monthly report forms.
- L. Provide sample bottles for split sampling.
- M. Plans and specifications.
- N. Operations and maintenance plan, including:

- i. Cleaning the fluoride saturator.
- ii. Cleaning fluoride solution inject lines.
- iii. Maintaining a complete spare chemical feed pump.
- iv. Testing backflow assemblies.
- v. Calibrating feed pump output periodically (using a calibration column).
- vi. Not adding NaF while the system is operating.
- vii. Preparing fluoride overfeed prevention and response plan.
- viii. Identifying the appropriate DOH monthly treatment plant report form. See [DOH fluoridation report forms](#) on our website.
- ix. Training specific to fluoride treatment for every operator with operational or maintenance responsibility.
- x. Confirming the certified operator reviewed and had the opportunity for input on the design and O&M plan.

Appendix F.3 Arsenic Removal by Coagulation/Filtration

Submittal Outline

This outline will guide and summarize your arsenic (As) treatment facilities' design for small water systems using groundwater sources. The following factors are important for the successful, reliable operation of an arsenic removal treatment facility using coagulation and filtration.

- Correct coagulant dose.
- Adequate oxidation of As(III) to As(V).
- Properly sized filter media.
- Complete and accurate raw water data at time of design.
- Appropriate filtration rate.
- Adequate backwashing frequency, rate, and control. Proper monitoring and control of the backwash recycle return (if applicable).

Because many factors affect design, and because raw water quality is so critical to selecting an appropriate treatment technique, we usually require design engineers to pilot test all facilities at the site, and to perform certain raw water quality tests on site.

An engineer licensed in Washington state must prepare submittals for water treatment facilities. You **must** include all supporting documentation with the design submittal (WAC 246-290-110).

F.3.1 General Water System Information

Provide the following general information:

- A. Water system name and public water system identification number.
- B. Owner's name, address, and telephone number.
- C. Manager's name, address, and telephone number.
- D. Operator's name, certification level, and telephone number.
- E. Completed (preliminary) [Purification Plant Criteria Worksheet](#) (include all existing and proposed treatment processes).
- F. Completed [Project Approval Application Form](#) (DOH 331-149-F).

F.3.2 Description of the Water Quality Problem

Describe the source of supply and the purpose and goals of the treatment proposed. Include source number and design flow rate(s).

F.3.3 Raw Water Quality

The raw water quality of most groundwater supplies can vary seasonally and over time. For this reason, a minimum of two separate measurements should be collected for the parameters listed below. In aquifers where the water quality is known to vary significantly, such as some island aquifers, we recommend additional raw water quality sampling. To get accurate data, a qualified person with a properly calibrated instrument must measure pH at the well site (not in a lab). A lab certified for drinking water **must** analyze all other water quality parameters (WAC 246-290-300(1)(c)). Submit all lab data sheets to DOH.

Raw Water Quality Table

Water Quality Parameters	Comment
Arsenic As (Total) (ug/L)	Speciation between As(III) and As(V) should be done in the field, with samples sent to labs. It is unnecessary if adequate preoxidation is provided. However, it can be useful in troubleshooting treatment.
Arsenic As(III)	
Arsenic As(V)	
Ammonia (mg/L)	An indicator of strong reducing conditions. Interferes with use of Cl ₂ as a preoxidant.
Calcium (mg/L)	High calcium reduces interference from Si, lowering the coagulant dose required.
Iron (mg/L)	Iron binds to arsenic so it can be removed. An iron to arsenic ratio of at least 20:1 is required for effective arsenic removal and can be 100:1 or greater depending on pH, and competition from Si, PO ₄ , TOC, etc.
Manganese (mg/L)	Mn removal is frequently desired if it exceeds the secondary MCL of 0.050 mg/L.
TOC (mg/L)	TOC exerts an iron demand, so at concentrations greater than 2.0 mg/L it can significantly affect iron dose and foul the filter media.
pH	pH strongly affects the ability of arsenic to bind to iron. Ideal range pH 7.0 or less. At pH >8.0, pH reduction may be beneficial.
Phosphate PO ₄ (mg/L)	Phosphate is chemically analogous to arsenate [As(V)]. Significant interference occurs at >0.040 mg/L.
Silica Si (mg/L as SiO ₂)	Silica can cause significant interference with arsenic binding to iron at pH>7.5 at 20 mg/L and 50 mg/L regardless of pH.

F.3.4 Pilot Testing

Pilot testing is usually necessary to determine whether a treatment process is functional, economically viable, and to develop the design parameters for the treatment process, including:

- A. Preoxidant type, dose, and contact time.
- B. Coagulant type, dose, and contact time.
- C. Filter media type, depth, and loading rate.
- D. Backwash frequency, duration, and hydraulic rate.
- E. Filter-to-waste duration and rate.
- F. Backwash recycle return (flow rate, volume per filter backwash cycle, quality), if applicable.
- G. Other process control parameters (if used) such as pH adjustment.

Inadequate arsenic pilot testing may result in treatment process performance inefficiencies or outright failure, delayed implementation of effective treatment, and costly retrofitting or replacement of treatment facilities. For these reasons, pilot plant testing, including the submittal of a pilot testing plan, will usually be required. At a basic level, the project report that summarizes the pilot testing should describe:

- H. Pilot plant setup, duration (see Table 10-2), and results as they relate to full scale treatment design.
- I. Pilot plant design parameters:
 - i. Treatment rate of the pilot plant (gpm/sq.ft.).
 - ii. Oxidant and dosage (mg/L), if applicable.
 - iii. Coagulant and dosage (mg/L).
 - iv. Length of oxidation and coagulant contact times. Contact time is detention time from point of oxidation or coagulation addition to filter.
 - v. Backwash parameters (filter run length/volume (hours or gals), backwash rate (gpm), duration (min)) and recycle return (if applicable).
 - vi. pH adjustment, if necessary.

F.3.5 Summarize Coagulation-Filtration Treatment Components

Include schematic drawing of the treatment system identifying:

- A. Major system components.
- B. Process control stations, such as water quality sampling points (raw, post-oxidant, post-coagulant, after each filter, combined filter effluent) flow meter(s), and pressure gauges, chlorine residual analyzer(s), turbidity meter(s)).

F.3.6 Full-Scale Design

The design engineer should cover the following items in the project report and construction documents:

- A. Process Control: Document location of and interaction between these process control components:
 - i. Sample locations:
 - a. Raw water (before any treatment).
 - b. After oxidant addition.
 - c. After iron addition, but before filtration.
 - d. After each filter.
 - e. Combined filter effluent.
 - f. Backwash recycle return, if applicable.
 - ii. Physical parameter and water quality analysis:
 - a. The frequency of monitoring should be identified for the flow, oxidant residual, iron, arsenic, pressure, and filtration volume or run time.
 - b. On-line or continuous water quality instrumentation can improve process control and aid in troubleshooting, so the use of chlorine residual analyzers, pH analyzers, and turbidimeters should be evaluated.
 - iii. Process control narrative describing:
 - a. Process control parameters (oxidant residual, target pH, iron concentration), means of process control, and benchmarks for successful operations.
 - b. Capacity for remote operations
 - c. Alarm and shutdown conditions
- B. pH Adjustment: Document pH adjustment design basis (if applicable)
 - i. Chemical used, dosage (mg/L), and target pH range.
- C. Oxidation: Type, dose, target residual, and oxidation process design basis.
 - i. Oxidant dose (mg/L)
 - ii. Target oxidant residual (mg/L)
 - iii. Contact Time (sec) between oxidant and iron addition (if added) or oxidant and filter (if not added). Usually 20–60 seconds is needed to convert As(III) to As(V) depending on oxidant and other water quality parameters.
If using ozone as an oxidant, see Appendix F.5 for submittal guidance.
- D. Natural Iron and Coagulant Addition: Document coagulant selection.

- i. Raw Water Fe/As Ratio.
An Fe/As mass ratio of at least 20:1 is required for effective arsenic removal, and may need to be greater than 100:1 in some cases.
 - ii. Coagulant:
Type, dose (mg/L), and monitoring approach.
- E. Flocculation: Document flocculation design basis
Time between coagulant addition and filtration vessel.
- F. Filter media
- i. Type, depth (usually at least 36 inches), effective size, and loading rate.
Filtration rate usually less than 5 gpm/sf for effective filtration, though may be higher for some solid manganese dioxide media if raw water quality is suitable and if demonstrated through pilot testing.
 - ii. Expected replacement frequency and sensitivity to oxidants.
 - iii. ANSI/NSF Standard 61 certification.
- G. Backwash: Document backwash design criteria and process.
- i. Describe design objective.
 - a. Optimize finished water quality.
 - b. Minimize backwash volume per cycle.
 - c. Maximize finished water volume.
 - ii. Identify backwash initiation
 - a. Head loss, psi or feet.
 - b. Time since last backwash, hours or days.
 - c. Volume of filtered water, gallons.
 - iii. Identify backwash hydraulics:
 - a. Flow rate (gpm/sf). Identify the manufacturer's recommended backwash application rate in gpm/sq.ft.
 - b. Identify the backwash pump pressure in psi. Attach pump curve. Verify adequacy of system hydraulics for the proposed backwash.
 - c. Backwash duration, in minutes.
 - d. Volume, in gallons.
 - e. Verify that no cross connection exists between the backwash source water and the wastewater.
 - iv. Backwash disposal
 - a. Volume of backwash per cycle, average day and peak day.

- b. Describe disposal of backwash, and include all backwash disposal facilities in construction documents.
 - c. Confirm that the proposed method of backwash waste disposal is acceptable to the Department of Ecology and the local health department. See Chapter 10 for guidance on permitting water treatment plant waste disposal.
- H. Backwash recycle return: Document backwash recycle return design basis, if applicable.
 - i. Backwash storage and return:
 - a. Backwash holding tank volume, in gallons.
 - b. Detention time, in hours.
 - c. Supernatant recycle return volume, in gallons.
 - d. Supernatant recycle return flow, gpm. The recycle return flow should not exceed 10 percent of the total influent to the filters.
 - ii. Conditioning supernatant recycle return:
 - a. Bag/cartridge filter
 - b. Chemical addition
 - c. Turbidity monitoring of supernatant recycle return stream
 - iii. Identify backwash recycle return initiation
 - a. Volume of backwash water, in gallons
 - b. Time since last backwash recycle return, in hours or days. We recommend recycling on a volume basis rather than time because production varies throughout the year.
- I. System Hydraulics
 - i. Describe source-pumping mode (pumps directly to storage or to distribution).
 - ii. Define the current installed source pumping capacity in gpm.
 - iii. Verify that the installed pumping capacity is adequate to meet current design standards with the proposed treatment on line. Discuss all components of the total pumping head (well pump lift, system elevation difference, treatment plant head loss, system head losses, and residual pressure).

F.3.7 Operations and Maintenance

Prepare an O&M manual section that:

- A. Identifies maintenance personnel and operators.
- B. Outlines routine daily, weekly, monthly, and annual inspection and maintenance.
- C. Identifies major equipment components and their manufacturers.
- D. Identifies a record keeping system to track treatment system performance.
- E. Contains your disinfection byproduct monitoring plan, if chlorine or ozone is used (not applicable to transient noncommunity systems).
- F. Identifies the appropriate DOH monthly treatment plant report form. Obtain the applicable reporting form from the DOH regional engineer.
- G. Confirms the certified operator reviewed and had the opportunity for input on the design and O&M plan.
- H. Includes arsenic treatment optimization goals. See [DOH Arsenic Treatment Optimization Program information](#).

Appendix F.4 Arsenic Removal by Adsorbents

Submittal Outline

This outline will guide and summarize your arsenic (As) treatment facility design for small water systems using adsorbents. The cost and performance of adsorbents varies widely. Both depend on the adsorbent type and raw water quality. Breakthrough can occur in as soon as a few weeks or last many months before needing replacement. Because very short run times can make the process economically unsustainable, pilot testing is usually necessary for adsorbents.

An engineer licensed in Washington state must prepare submittals for water treatment facilities. You **must** include all supporting documentation with the design submittal (WAC 246-290-110).

F.4.1 General Water System Information

Provide the following general information:

- A. Water system name and public water system identification number.
- B. Owner's name, address, and telephone number.
- C. Manager's name, address, and telephone number.
- D. Operator's name, certification level, and telephone number.
- E. Completed (preliminary) [Purification Plant Criteria Worksheet](#) (include all existing and proposed treatment processes).
- F. Completed [Project Approval Application Form](#) (DOH 331-149-F).

F.4.2 Description of the Water Quality Problem

Describe the source of supply and the purpose and goals of the treatment proposed. Include source number and design flow rate(s).

F.4.3 Raw Water Quality

The raw water quality of most groundwater supplies can vary seasonally and over time. For this reason, a minimum of two separate measurements should be collected for the parameters listed below. In aquifers where the water quality is known to vary significantly, such as some island aquifers, we recommend additional raw water quality sampling. To get accurate data, a qualified person with a properly calibrated instrument must measure pH at the well site, not in a lab. A laboratory certified for drinking water **must** analyze all other water quality parameters (WAC 246-290-300(1)(c)). Submit all lab data sheets to DOH.

Raw Water Quality Table

Water Quality Parameters	Comment
Arsenic As (Total) (ug/L)	You should do speciation between As(III) and As(V) in the field, and send samples to labs. Speciation is not necessary if adequate preoxidation is provided. However, it can be useful in troubleshooting treatment.
Arsenic As(III)	
Arsenic As(V)	
Ammonia (mg/L)	An indicator of strong reducing conditions. Interferes with use of Cl ₂ as preoxidant.
Calcium (mg/L)	High calcium reduces interference from Si leading to longer adsorbent runs.
Iron (mg/L)	Iron in excess of 0.3 mg/L may cause fouling of the adsorbent and may cause excessive backwashing.
Manganese (mg/L)	Mn removal is frequently desired if it is greater than the secondary MCL of 0.050 mg/L.
TOC (mg/L)	TOC in excess of 2 mg/L may cause fouling of the adsorbent and may result in the need for excessive backwashing.
pH	pH strongly affects the ability of arsenic to bind to iron. Ideal range pH 7.0 or less. At pH >8.0, pH reduction may be beneficial.
Phosphate PO ₄ (mg/L)	Phosphate is chemically analogous to arsenate. Significant interference occurs at >0.040 mg/L.
Silica Si (mg/L as SiO ₂)	Silica can prevent arsenic binding to the adsorbent at pH>7.5 at 20 mg/L and 50 mg/L regardless of pH.

F.4.4 Pilot Testing

Pilot testing usually is necessary to determine whether a treatment process is functional and economically viable and to develop the design parameters for the treatment process, including:

- A. Preoxidant type, dose and contact time.
- B. Volume of water treated to breakthrough, expressed in term of bed volumes.
- C. Backwash frequency, duration, and hydraulic rate.
- D. Backwash recycle return (flow rate, volume per filter backwash cycle, quality) if applicable.
- E. Other process control parameters (if used), such as pH adjustment.

Inadequate arsenic pilot testing may cause treatment-process performance inefficiencies or outright failure, delay implementation of effective treatment, and require costly retrofitting or replacement of treatment facilities. For these reasons, pilot plant testing, including the submittal of a pilot testing plan, will usually be required. At a basic level, the project report that summarizes the pilot testing should describe:

- F. Pilot plant setup, duration (see Table 10-2), and results as they relate to full-scale treatment design.
- G. Pilot plant design parameters:
 - i. Treatment rate of the pilot plant (gpm/sq.ft. or gpm).
 - ii. Oxidant and dosage (mg/L) (if applicable).
 - iii. Length of oxidation contact time. Oxidation contact time is detention time from point of oxidation addition to adsorbent vessel.
 - iv. Backwash parameters (filter run length/volume (hours or gals), backwash rate (gpm), duration (min)) and recycle return (if applicable).
 - v. pH adjustment (if necessary)
- H. Estimate the number of bed volumes that can be treated before exhausting the adsorbent media and describe the basis for the estimate.

F.4.5 Summarize Adsorbent Treatment Components

Include a schematic drawing of the treatment system identifying:

- A. Major system components.
- B. Process control stations, such as water quality sampling points (raw, post-pH adjustment, post-oxidant, after each filter, combined filter effluent) flow meter(s), pressure gauges, chlorine residual analyzer(s), turbidimeter(s).

F.4.6 Full-Scale Design

- A. Process Control: Document location of and interaction between these process control components:
 - i. Sampling taps:
 - a. Raw water (before any treatment)
 - b. After oxidation
 - c. Before adsorbent vessel(s)
 - d. After adsorbent vessel(s)
 - e. Combined adsorbent effluent
 - f. Other
 - ii. Physical parameter and water quality analysis:

- a. The frequency of monitoring should be identified for the flow, oxidant residual, iron, arsenic, pressure, and filtration volume or run time.
 - b. On-line or continuous water quality instrumentation can improve process control and aid in trouble shooting, so you should evaluate use of chlorine residual analyzers, pH analyzers, and turbidimeters.
 - iii. Process control narrative describing:
 - a. Process control parameters (oxidant residual, target pH, iron concentration), means of process control, and benchmarks for successful operations.
 - b. Capacity for remote operations.
 - c. Alarm and shutdown conditions.
- B. pH Adjustment: Document pH adjustment design basis, if applicable. Chemical used, dosage (mg/L), and target pH range.
- C. Oxidation: Type, dose, target residual, and oxidation process design basis
 - i. Oxidant dose (mg/L)
 - ii. Target oxidant residual (mg/L)
If using ozone as an oxidant, see Appendix F.5 for submittal guidance.
 - iii. Contact Time (sec) between oxidant and iron (if added) or oxidant and filter (if not added). Usually 20–60 seconds is needed to convert As(III) to As(V); time depends on oxidant and other water quality parameters.
- D. Adsorption Process: Document adsorbent and adsorption design basis
 - i. Prefiltration
 - a. None
 - b. Bag/cartridge filter
 - ii. Adsorbent Media
 - a. Adsorbent name and manufacturer.
 - b. Configuration (series or parallel).
 - c. Loading rate (gpm/sf).
 - d. Depth (inches).
 - e. Empty bed contact time (EBCT, in minutes). Usually EBCT is at least 5 minutes. EBCT calculated as $[\text{Volume of media (ft}^3\text{)} * 7.48 \text{ gal/ft}^3 / Q \text{ (gal/min)}]$.
 - f. NSF 61 certification.
 - g. Disposal options and requirements with adsorbent media exhaustion.

- E. Backwash: Document backwash design criteria and process
 - i. Describe design objective.
 - a. Optimize finished water quality.
 - b. Minimize backwash volume per cycle.
 - c. Maximize finished water volume.
 - ii. Identify parameters for backwash initiation
 - a. Head loss (psi or feet)
 - b. Run time since last backwash (hours/days)
 - c. Volume of filtered water (gal)
 - iii. Identify backwash hydraulics:
 - a. Flow rate (gpm/sf). Identify the manufacturer's recommended backwash application rate in gpm/sq.ft.
 - b. Identify the backwash pump pressure in psi. Attach pump curve. Verify adequacy of system hydraulics for the proposed backwash.
 - c. Backwash duration, in minutes
 - d. Volume.
 - e. Verify no cross connection exists between the backwash source water and the wastewater.
 - iv. Backwash disposal
 - a. Describe constituents, average day, and peak day volume of backwash.
 - b. Describe disposal of backwash, and include all backwash disposal facilities in construction documents.
 - c. Confirm that the proposed method of backwash waste disposal is acceptable to the Department of Ecology and the local health department. See Chapter 10 for guidance on permitting water treatment plant waste disposal.
- F. Backwash Recycle Return: Document backwash recycle return design basis, if applicable
 - i. Backwash storage and return
 - a. Backwash holding tank volume, gallons.
 - b. Detention time, hours.
 - c. Supernatant recycle return volume, gallons.
 - d. Supernatant recycle return flow, gpm.
 - ii. Conditioning supernatant recycle return

- a. Bag/cartridge filter.
 - b. Settling.
 - c. Turbidity monitoring of supernatant recycle return stream.
 - iii. Identify backwash recycle return initiation
 - a. Volume of backwash water, gallons.
 - b. Time since last backwash recycle return, in hours or days. You should recycle on a volume basis rather than time, because production varies throughout the year.
- G. System Hydraulics
- i. Describe source-pumping mode (pumps directly to storage or to distribution).
 - ii. Define the current installed source pumping capacity, in gpm.
 - iii. Verify that the installed pumping capacity is adequate to meet current design standards with the proposed treatment on line. Discuss all components of the total pumping head (well pump lift, system elevation difference, treatment plant head loss, system head losses, and residual pressure).

F.4.7 Operations and Maintenance

Prepare an O&M manual section:

- A. Identify maintenance personnel and operators.
- B. Outline routine daily, weekly, monthly, and annual inspection and maintenance.
- C. Identify major equipment components and their manufacturers.
- D. Identify a record keeping system to track treatment system performance.
- E. Disinfection byproduct monitoring plan (does not apply to transient noncommunity systems).
- F. Identify the appropriate DOH monthly treatment plant report form. Obtain the applicable reporting form from our regional engineer.
- G. Confirm that the certified operator reviewed and had the opportunity for input on the design and O&M plan.
- H. Arsenic treatment optimization goals. See [DOH Arsenic Treatment Optimization Program information](#).

Appendix F.5 Use of Ozone in Groundwater Treatment

Submittal Outline

This outline supplements the outline in Appendix F.3, F.4, and F.10. It provides general guidance on the use of ozone as a prefilter oxidant on groundwater sources.

F.5.1 Raw Water Quality

1. Based on actual water quality results, show ozone demand calculations for the water to be treated.
2. Identify the benefits that the proposed ozone treatment facilities can achieve.
3. Identify any adverse effects that the proposed ozone treatment system may have on other water quality parameters (disinfection byproduct generation, increased corrosivity, and nutrient source for regrowth bacteria).
4. Discuss the effect of the proposed ozone treatment on the requirements of the Ground Water Rule and the Disinfection and Disinfection Byproducts Rules.

F.5.2 Pilot Plant Testing

Inadequate pilot testing has caused treatment process failures, delayed implementation of effective treatment, and required costly replacement of inadequate treatment. For these reasons, we usually require pilot testing, including the submittal of a pilot testing plan. Appendix F.3, F.4, F.10, and Section 10.3 have additional information on pilot testing. At a basic level, the project report that summarizes the pilot testing should describe:

- A. Pilot plant setup, duration and results as they relate to full scale treatment design.
- B. Pilot plant design parameters:
 - i. Treatment rate of the pilot plant (gpm/sq.ft. or gpm).
 - ii. Ozone dosage (mg/L).
 - iii. Ozone demand and decay coefficients
 - iv. Length of oxidation contact time. Oxidation contact time is detention time from point of oxidation addition to coagulant or filter/adsorbent vessel.
- C. How long was the pilot plant operated? What seasonal changes in water quality may affect the performance of the proposed treatment plant?

F.5.3 Full-Scale Design

- A. Oxidation by Ozone

Provide a written description and specifications of the proposed treatment plant. Include engineering drawings with appropriate labels.

- i. Feed Gas Preparation
 - a. Identify the type of supply gas (air, pure oxygen, other).
 - b. Describe the method of gas drying. What is the seasonal variation in air moisture and can the gas be dried to a maximum dew point of -60C (-76F)?
 - c. Describe how feed gas is supplied to the generator (pump, and venturi). Define the operating pressures? (If using a compressor, specify "oil free").
- ii. Ozone Generation
 - a. Identify the type of ozone generator (corona discharge, other). The minimum concentration of ozone in the generator exit gas should not be less than 1 percent (by weight).
 - b. Define the ozone production rate (g/hr., lbs/day) and ozone concentration (mg/L).
 - c. Specify a minimum of two generators, each sized to provide 50 percent of peak flow or similar alternative.
 - d. Verify that the existing power supply can meet the electrical needs of generators. Are the electrical components safety certified?
 - e. Describe the method of generator cooling.
 - f. Specify corrosion resistant components in the ozone generator.
 - g. Has an independent laboratory certified the specified ozone generator? If so, list the certifying agent.
- iii. Ozone Dissolution / Contact Vessel
 - a. Describe the method for introducing ozone into the raw water stream (venturi, pump, diffuser, other). Identify operating parameters of method used (such as pressure differential, counter-current flow, mitigation of precipitate formation).
 - b. Identify the necessary contact vessel required to provide contact time. Include sizing calculations and basis for sizing. Is contact vessel resistant to corrosion?
 - c. Include a pressure or vacuum relief valve on the contact vessel; show that it is piped to a location for safe discharge.
 - d. Identify on a drawing controls for cleaning, maintenance and drainage of the contact vessel.
- iv. Off-gas Destruction Unit

Describe a system that meets safety and air quality standards for treating off-gas from the contact vessel (Washington Industrial Safety and Health Act - WISHA -Chapter 296-841 WAC- the maximum permissible exposure is 0.30 mg/L for 15-minute exposure). If undissolved ozone gas from the contact vessel is recirculated, demonstrate that the ozone concentration (off-gas) in downstream storage vessels is within standards and that the vessel is not subject to excess corrosion.

v. Piping Materials

Specify pipe material with demonstrated corrosion resistivity (such as low carbon 304L or 316L stainless for ozone service, non-solvent welded UPVC pipe, Teflon valve seats). Identify a replacement schedule if the manufacturer recommends it.

vi. Ozone Facility Instrumentation

- a. Pressure gauges and air flow meters to monitor the ozone generation process (such as at discharge of air compressor, inlet to ozone generators, and inlet to ozone destruct unit).
- b. Dew point monitor to measure the moisture of the feed gas.
- c. Ozone monitors (or alternate equivalent) to measure ozone concentration in the feed gas, undissolved gas in the contact vessel, ozone residual prior to filtration, ozone residual post filtration and in the off gas from the destruct unit.
- d. An ambient ozone monitor (or alternate equivalent) near the contact vessel and generator.
- e. An emergency electrical shut-down accessible from outside of the treatment building.

vii. Ozone Facility Alarms

- a. Dew point shutdown or alarm.
- b. Ozone generator cooling water flow, temperature and power shutdown or alarm.
- c. Ambient ozone concentration shutdown or alarm.

F.5.4 Operations and Maintenance

Prepare an O&M manual section:

- A. Identify maintenance personnel and operators.
- B. Outline routine daily, weekly, monthly, and annual inspection and maintenance.
- C. Identify major equipment components and their manufacturers.

- D. Identify a record keeping system to track treatment system performance.
- E. Safety reference WISHA, which establishes permissible levels of airborne contamination (chapter 296-841 WAC).
 - i. Provide the manufacturer's Material Safety Data Sheet for ozone. Post a copy of the data sheet in an obvious place in the treatment house.
 - ii. Provide a summary of the health effect of exposure to ozone. Post a copy of these health effects in an obvious place in the treatment house.
 - iii. Identify first aid procedures related to ozone exposure.
 - iv. If unsafe ozone gas is present, define a procedure for exhausting the building and system shutdown (for example, familiarization with ambient ozone monitor function and procedures, or other). How is building access determined to be safe?
- F. Disinfection byproduct monitoring plan (does not apply to transient noncommunity systems).
- G. Miscellaneous
 - i. Sampling taps for both raw and finished water and after each treatment unit.
 - ii. Totalizing meter to record total volume treated.
 - iii. Flow proportioned ozone feed.
- H. Confirm that the certified operator reviewed and had the opportunity for input on the design and O&M plan.

Appendix F.6 Reverse Osmosis for Desalination of Seawater or Estuarine Water

At present, reverse osmosis (RO) treatment of an open sea or seawater source is not subject to Washington's Surface Water Treatment Rule requirements (Part 6 WAC 246-290). Estuary and brackish sources of water may be subject to the Surface Water Treatment Rule, depending on the degree of surface runoff supplying the proposed intake and the viability of protozoa. Washington has some small seawater RO systems, all located in northern Puget Sound.

Before initiating design or planning, check with the DOH regional engineer for treatment requirements and process control or monitoring parameters that apply to your specific project.

F.6.1 General Water System Information

Provide the following general information:

- A. Water system name and public water system identification number.
- B. Owner's name, address, and telephone number.
- C. Manager's name, address, and telephone number.
- D. Operator's name, certification level, and telephone number.
- E. Completed (preliminary) [Purification Plant Criteria Worksheet](#) (include all existing and proposed treatment processes).
- F. Completed [Project Approval Application Form](#) (DOH 331-149-F).

F.6.2 Permitting (verify with local, state, tribal and federal agencies)

The county planning department usually will issue final approval for the facility. However, many different governmental agencies must review and approve a desalination facility. The following list includes key required permits and reviews. If your project involves tribal lands, check with all levels of government including tribal authorities.

- A. Water Right Permit (contact Department of Ecology for current requirements)
- B. Shorelines Permit (county) (includes SEPA)
- C. Building Permits (county)
- D. Discharge Permit/NPDES (Department of Ecology)
- E. 401 Water Quality Certification (Department of Ecology)
- F. Wash. Dept. of Fish and Wildlife (Hydraulic Project Approval – HPA)
- G. Wash. Dept. of Natural Resources (Aquatics resource use authorization and easement)

- H. U.S. Fish and Wildlife and the National Marine Fisheries Service (both review for effect to Endangered Species Act listed species and comment through the US Army Corps of Engineers permitting process)
- I. U.S. Army Corps of Engineers (Joint Aquatic Resource Permit Application-JARPA – Section 404 or section 10 permit) (Section 404 is for placing fill in marine waters and section 10 is for working in marine waters)
- J. Franchise from County Public Works (depends on the location of waterlines, etc.)
- K. Wash. Dept. of Health (Engineering report, construction documents approval)

F.6.3 Pilot Study

Pilot studies are an important way to determine RO pretreatment requirements and potential fouling characteristics of the raw and pretreated water. A pilot study may not be necessary if other plants with the same raw water quality are operating near the proposed project. Contact the appropriate DOH regional office to discuss. If a pilot study is needed, see Section 10.3 for guidance.

With or without a pilot study, the water system's management and operators should visit plants similar to theirs. Understanding the complexity of the treatment process and its operational and maintenance requirements and costs will inform decision-making and system design.

F.6.4 Project Report

The engineering or project report should cover the design issues described in Chapter 2 and Chapter 10. As you develop your treatment design, you should consider redundancy, accessibility, manned and remote operations, alarm conditions, and treatment monitoring and performance expectations. Pay special attention to:

- A. Intake and Brine Discharge Considerations
 - i. Shallow well or infiltration gallery location and design. The intake should be more than 200 feet from any source of contamination (septic drain field, fuel storage, chemical storage, waste discharge). We do not recommend these types of intakes due to significant problems associated with maintenance and with access.
 - ii. When you locate a direct seawater intake, you should consider ease of maintenance, protection from damage (for example, by boat anchors), and the potential for contamination from a fuel spill and sewage discharge. Environmental concerns will drive both intake and discharge design. You should consider redundant piping when intakes are in sensitive areas.

- iii. Intake pipe fouling from mollusks can be a significant issue affecting ongoing operations depending upon intake location. Design should address this issue. Successful approaches have included alternating the intake line and the brine discharge lines (brine kills the mussels); oversizing intake lines and physical cleaning (requires access ports).
 - iv. Intake pump considerations. The intake pump, whether submersible (in seawater) or located on a dock, is subject to severe environmental stress. Pay careful attention to the quality of stainless steel selected and the use of different metals in proximity to each other. If you cannot find a submersible pump designed for seawater, you may use a standard pump with frequent monitoring, inspection, and repair incorporated into the design.
- B. Raw water quality including temperature and salinity by season. Puget Sound waters are of high quality but subject to seasonal turbidity events, changes in salinity, and very cold temperatures. Local areas may have significant algal blooms and be subject to mollusk fouling. You may need to get this information from existing nearby seawater RO plants.
 - C. Treated water design criteria. Total dissolved solids (TDS) and conductivity are usually used to control permeate acceptance. Conductivity is directly measured and then an assumed salinity conversion factor is used to estimate TDS. The conversion factor used must be identified. Affirm that the conversion factor is appropriate for the seawater intake location. Identify finished water alkalinity and pH goals. Finished water TDS following pH and alkalinity adjustment **must** be less than 500 mg/L (WAC 246-290-310). TDS of the RO permeate should be less than 350 mg/L.
 - D. Membrane design criteria and selected membrane characteristics (membrane type and configuration). ANSI/NSF 61 certification is required. Expected recovery rate (percent), useful life of membrane, and expected membrane replacement schedule should be determined.
 - E. Membrane cleaning. If cleaning is to be performed onsite, environmental issues for waste disposal must be addressed (See Section 10.8).
 - F. High-pressure pump design pump sizing. Engineers frequently size pumps together with the seawater RO membrane supplier. Consideration for startup and shutdown should be included along with the ability of all components to handle expected operating pressures.
 - G. Energy recovery systems. A significant portion of the energy used for the high-pressure RO feed pump can be recovered from the concentrated brine stream, thereby reducing energy costs. We recommend using energy recovery systems.
 - H. Pretreatment of the seawater. Pretreatment is the most critical component for a successful treatment system. Puget Sound waters are of high quality but are

subject to seasonal turbidity events, and very cold temperatures. Local areas may have significant algal blooms and be subject to severe mollusk (primarily mussels) fouling. Successful installations to date have pretreatment operating independently of the seawater RO system. Pretreatment systems deliver water to a filtered or treated seawater tank or tanks. The RO high-pressure pump draws from the seawater tank. Pretreatment considerations may include turbidity reduction, Fe/Mn removal, anti-scale stabilization, microbial control, organics reduction and hardness reduction.

- I. Brine as a resource. Brine is a filtered water source, not just a waste stream. Store on site and use it to backwash a pressure media filter or to inhibit marine growth in intake lines.
- J. Equipment operation and maintenance. Describe instrumentation and controls, including alarms, telemetry for remote operation, and provisions for protecting instrumentation and electrical components from corrosion.
- K. Product water corrosivity. The corrosive nature of RO permeate requires corrosion control treatment for all seawater RO installations. Blending with other sources as the sole means of corrosion control is not acceptable. Alkalinity and pH treatment ranges should be identified. Instruments employing EPA-approved methods for measuring pH and alkalinity **must** be used (WAC 246-290-300(1)(c)).
- L. Disinfection. Disinfection for providing at least a CT of 6 (WAC 246-290-451(4)(e)). Water may be very cold, which affects contact time requirements.
- M. Material compatibility. Piping and fittings material compatible with seawater and low ionic strength permeate water should be carefully evaluated.
- N. Operation and maintenance. The treatment plant design should give extra thought to equipment accessibility for maintenance. Some examples include:
 - i. Setting the high pressure pump at waist height with full access for maintenance and repairs (HP pumps typically require frequent maintenance)
 - ii. Providing open space to allow membrane removal from the pressure vessels.
 - iii. Locating sampling taps and water meters for easy access and reading.
 - iv. Labeling all treatment plant piping and equipment.
- O. Operator qualifications. A certified operator is required to operate this treatment facility. Operator certification requirements and the availability of qualified operators is a critical component for determining whether seawater RO is a viable and sustainable option.
- P. Noise. Sound proofing and noise abatement should be evaluated.

F.6.5 Operations and Maintenance Manual

- A. Identify maintenance personnel and operators.
- B. Outline routine daily, weekly, monthly, and annual inspection and maintenance.
- C. Identify major equipment components and their manufacturers.
List spare parts, chemicals, and supplies to keep on hand.
- D. Establish written procedures for:
 - i. Collecting water quality and treatment performance data and keeping records.
 - ii. Adding chemical and determining chemical dosages.
 - iii. Testing and reporting conductivity-TDS meter calibration and maintenance processes.
 - iv. Membrane cleaning, rejuvenation, and/or replacement, including the care and storage of the RO membranes when not in operation. We recommend using unchlorinated permeate water.
 - v. Plant start-up and shut-down.
- E. Prepare a disinfection byproduct monitoring plan (does not apply to transient noncommunity systems).
- F. Identify the appropriate DOH monthly treatment plant report form. Obtain the applicable reporting form from your regional engineer.
- G. Confirm that the certified operator reviewed and had the opportunity for input on the design and O&M plan.

F.6.6 Other Design Considerations

- A. All components in substantial contact with the product or raw water, including membranes, **must** be ANSI/NSF Standard 61 certified (WAC 246-290-220).
- B. All chemicals used **must** be within their ANSI/NSF Standard 60 approved doses (WAC 246-290-220).
- C. Use noncorrosive materials (stainless steel, PVC, fiberglass) throughout the treatment plant.

Appendix F.7 Rainfall Catchment Submittal Requirements

Rooftop catchment involves collecting rainfall from an elevated roof surface. Rainwater collected from ground catchment areas is stormwater. Depending on the specific roof characteristics for collecting rainfall, rooftop water can be subject to animal and human pathogens, material degradation from roof components, and windblown contaminants.

Additionally, most rooftop catchment-systems collect untreated rainwater and store it in large cisterns. This cistern water may be stored for months before the water is used. Water quality changes can occur during this protracted storage. For these reasons, we treat rooftop catchment systems as surface water sources for purposes of treatment design and treatment operations.

Water systems **must** obtain drinking water from the highest quality source feasible (WAC 245-290-130). Water systems **must** provide an adequate quantity and quality of drinking water in a reliable manner (WAC 246-290-420). Using collected rainwater from a rooftop catchment system poses significant challenges to satisfying these basic requirements. We know from experience that small water systems struggle with demonstrating compliance in operating a small surface-water treatment plant. As presented in Appendix F.8, we believe it is difficult to develop a reliable rooftop catchment system in most areas of the state without incurring significant construction and ongoing operation and maintenance costs.

Submittal Outline

The design submittal requirements for a new surface water source and potable water treatment facility are substantial. Even very small rainfall rooftop catchment designs **must** meet all of the requirements of Part 6 of WAC 246-290. Refer to additional guidance in Appendix A.3.8 and Chapter 11.

I. General Water System Information

Provide the following general information:

- A. Water system name and public water system identification number.
- B. Owner's name, address, and telephone number.
- C. Manager's name, address, and telephone number.
- D. Operator's name, certification level, and telephone number.
- E. Completed (preliminary) [Purification Plant Criteria Worksheet](#) (include all existing and proposed treatment processes).
- F. Completed [Project Approval Application Form](#) (DOH 331-149-F).

II. Checklist of Additional Items

- A. Rain is acidic and very low in dissolved solids and alkalinity. As a result, it can leach contaminants from materials it contacts. Therefore, all roofing materials in contact with rainfall **must** be certified under ANSI/NSF 61 or NSF P151 (WAC 246-290-220). This requirement extends to all equipment and appurtenances on the roof substantially contacted by rainfall, including solar panels, satellite dishes, chimneys, and vents.
- B. Because of rainfall's corrosive potential, evaluate the need for corrosion control treatment and the effect on the distribution system.
- C. Address all applicable new surface water source treatment considerations.
- D. Water rights Department of Ecology administrators may be required depending on the location and size of the project.
- E. Provisions for ongoing raw water cistern inspection, water quality sampling, and cistern cleaning and maintenance must be incorporated into the design.
- F. Address service capacity (source capacity and storage) requirements if you intend to use the rooftop catchment source to meet part or all of the water system's source firm-yield requirements without depending on trucked water. Refer to Appendix F.8.
- G. Review the Department of Ecology's policy on rainwater collection. The policy is on Ecology's [Rainwater Collection webpage](#).

Appendix F.8 Rainfall Catchment Reliability Analysis – Example

Introduction

The main points of this reliability analysis are:

- The importance of assessing rainfall data collected over many years.
- The source of supply and/or reliability analysis must be based on drought conditions. Designing a roof top catchment system based on average rainfall data will result in an unreliable water supply.
- Reliability analysis should be based on the 50-year drought, using monthly (not annual) rainfall data.

Annual Rainfall

The generally accepted equation for rainfall yield from a roof surface is:

$$0.8 \text{ (efficiency of rainfall capture)} \times 0.62 \text{ (gallons per inch of rainfall per square foot of roof)} \times \text{SF (capture area of roof)} \times \text{inches of rainfall per time period}$$

For example, a building with a 1,500 SF roof capture area receiving an average annual rainfall of 40 inches per year will yield a water supply volume of $0.8 \times 0.62 \times 1,500 \times 40 = 29,760$ gallons, sufficient to provide the equivalent of 81 gallons per day (average daily supply). As described below, calculating an average supply from an average annual rainfall does not result in a reliable potable water supply.

Many locations in Washington have extensive data on monthly and annual rainfall (see Appendix C for weather and rainfall webpages). Rainfall information was reviewed from three locations, each with 62 years of data (1949-2010):

- Olympia
- SeaTac
- Orcas Island

Rainfall information for areas east of the Cascade Range indicate less average rainfall and longer, more severe drought potential compared with the three locations noted above.

We calculated the mean (μ), standard deviation (σ), and -2σ of this data in an effort to assess the feasibility of rainfall rooftop catchment (RRC) for community water systems.

Figure 1
Graphical Depiction of Standard Deviation

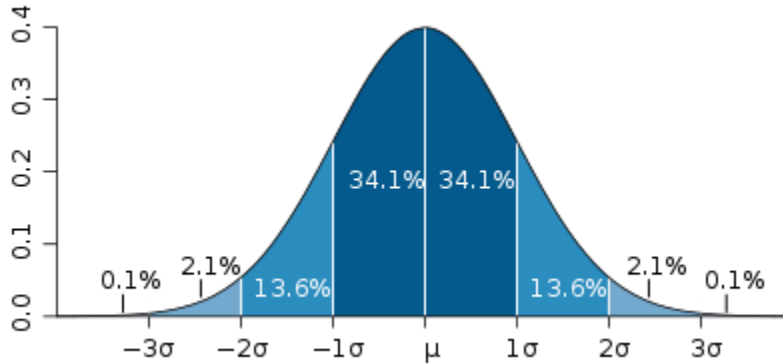

Assuming annual rainfall data follows a normal distribution, 2.2 percent of annual values are expected to be below -2σ . The probability of annual rainfall occurring below -2σ in any given year is about 1 in 50.

Below is the annual rainfall distribution curve for SeaTac. Rainfall frequency was measured in 5-inch increments.

Figure 2
Average Annual Rainfall Distribution for SeaTac

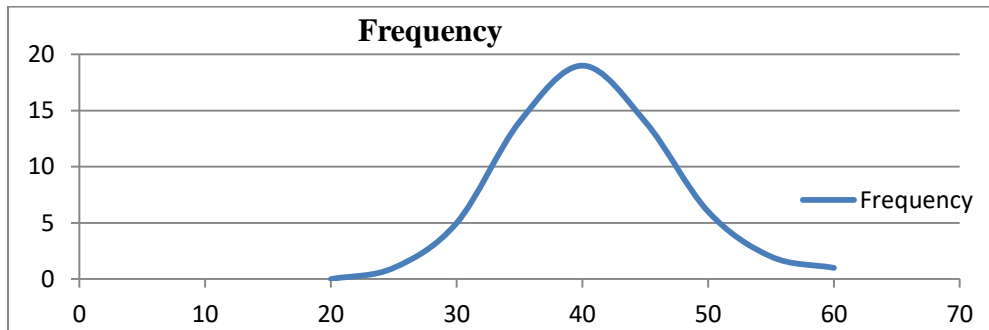

Table 1
Statistical Information on Annual Rainfall in Selected Washington Cities (inches)
1949-2010

Location	μ	Median	σ	Rainfall at -2σ	Range of Measured Rainfall
Olympia	50.63	52.31	8.37	33.89	29.92 to 66.71
SeaTac	38.2	39.73	6.58	25.04	23.78 to 55.14
Orcas Island	28.65	30.42	4.29	20.07	17.07 to 37.21

The annual rainfall for the design year will define the threshold where we consider RRC a viable sole-source of supply to a public water system. Section 5.9.1 and 5.11.1 recommends using a 98 percent level of reliability, equivalent to a 50-year drought, for surface supplies (including RCC).

We can approximate the threshold of low annual rainfall predicted once every 50 years (2 percent chance of occurring in any given year) by applying the **-2 σ** value for rainfall at a given location.

Applying the **-2 σ** rainfall value assumes a ~ 98 percent reliability standard. This standard implies a 1-in-50 chance that in any given year the rainfall will be less than the **-2 σ** rainfall value, and a 1-in-5 chance that the rainfall will be less than the **-2 σ** rainfall value during any consecutive 10-year period.

Table 2
Average Daily Water Supply per Dwelling (based on rainfall at -2 σ)

Location	Rainfall at -2σ	Ave Daily Supply (1500 SF Roof per Dwelling)	Ave Daily Supply (2000 SF Roof per Dwelling)
Olympia	33.89 in	68 gpd per house	91 gpd per house
SeaTac	25.04	50	67
Orcas Island	20.07	40	53

For reference, Forks, Washington has a **-2 σ** rainfall value of 82 inches per year (based on the same 62-year data period: 1949-2010), providing an average daily supply of 165 gpd per dwelling.

Lacking existing system information, Appendix D implies an appropriate design value for indoor use as 200 gallons per dwelling per day.

Monthly Rainfall

Annual rainfall dictates the feasibility of captured rainfall as a public drinking water supply. The distribution of the annual rainfall dictates the reservoir (cistern) size needed to ensure a continuous supply of water during periods of little or no rainfall. We reviewed data from the three locations to determine the number of years in which the aggregate rainfall measured in any consecutive three-month period totaled less than 1.0 inches. Table 3 tabulates the results:

**Table 3
Critical 3-Month Dry Periods**

Location	Number of Years with 3-Month Total Rainfall Less Than 1.0 Inches	Minimum 3-Month Total Rainfall		
		Rainfall	Year	Equivalent supply ¹
Olympia	4 (1951, 1970, 1998, 2006)	0.45 inches	1970	3.6 gpd
SeaTac	2 (1967, 1987)	0.84 inches	1987	6.9 gpd
Orcas Island	1 (1951)	0.94 inches	1951	7.7 gpd

¹ Average daily supply available from rainfall during this 3-month period, based on a 1,500 sf roof and 91 days

There are also longer periods of relatively dry weather. In 1987 there was a five-month period (June to October) with total rainfall of 2.06 to 2.09 inches at these three locations. This level of rainfall equates to an average daily supply of 10 gpd per dwelling during the five-month period.

Based on the history of monthly rainfall, the cistern size needed to overcome the uneven distribution of rainfall during the year at these three locations would have to be on the order of five months' supply, equal to about 30,000 gallons per dwelling unit assuming 200 gallons per day average daily demand. Storing captured rainfall for many months will result in significant degradation of water quality.

Providing for fire flow, disinfection contact time, a factor of safety (to account for climate change), and accounting for hydraulic inefficiency of the treatment process will only serve to increase the total storage needed (untreated and treated).

Conclusion

The annual and monthly variability of rainfall makes harvested rainfall difficult to justify as a sole-source drinking water supply for community water systems in all but the wettest parts of Washington.

Appendix F.9 Iron and Manganese Treatment by Oxidation Filtration

Submittal Outline

This outline will guide and summarize your iron (Fe) and manganese (Mn) treatment facility design for small water systems using groundwater sources. Refer to Appendix F.5 if your Fe/Mn treatment process will use ozone as a prefilter oxidant.

In various surveys of iron and manganese treatment facilities in the U.S., only 50 to 60 percent of the facilities produced water that met drinking water standards for iron (Fe) and manganese (Mn). The following factors are important for the successful, reliable operation of a Fe/Mn removal treatment facility using oxidation filtration.

- Correct oxidant dosage.
- The oxidation pH is sufficiently high and oxidation time is sufficiently long to ensure conversion of soluble Fe/Mn to the oxidized state.
- Properly sized filter media.
- Complete and accurate raw water data at time of design, including an understanding of iron complexation with humic substances or silica.
- Appropriate filtration rate.
- Adequate backwashing frequency, rate, and control. Proper monitoring and control of the backwash recycle return (if applicable).

An engineer licensed in Washington state must prepare submittals for treatment facilities. All supporting documentation **must** be included with the design submittal (WAC 246-290-110).

F.9.1 General Water System Information

Provide the following general information:

- A. Water system name and public water system identification number.
- B. Owner's name, address, and telephone number.
- C. Manager's name, address, and telephone number.
- D. Operator's name, certification level, and telephone number.
- E. Completed (preliminary) [Purification Plant Criteria Worksheet](#) (include all existing and proposed treatment processes).
- F. Completed [Project Approval Application Form](#) (DOH 331-149-F).

F.9.2 Description of the Water Quality Problem

Describe the source of supply and the purpose and goals of the treatment proposed. Include source number and design flow rate(s).

F.9.3 Raw Water Quality

The raw water quality of most groundwater supplies can vary seasonally and over time. For this reason, a minimum of two separate measurements should be collected for the parameters listed below, ideally capturing seasonal changes in raw water quality. In aquifers where the water quality is known to vary significantly, such as some island aquifers, we recommend additional raw water quality sampling. To get accurate data, a qualified person with properly calibrated instruments must measure temperature, ferrous iron, and pH at the well site (not in a lab). A laboratory certified for drinking water **must** analyze all other water quality parameters (WAC 246-290-300(1)(c)). Submit all lab data sheets to DOH.

Raw Water Quality Table

Water Quality Parameters	Comment
Total Iron (mg/L)	The concentration of total iron can affect the filter run time, treated water quality, and economics of the treatment process.
Ferrous (Fe ⁺²) Iron (mg/L)	Ferrous iron exerts an oxidant demand requiring higher concentrations of oxidant addition.
Manganese (mg/L)	The concentration of total manganese can affect the filter run time, treated water quality, and economics of the treatment process.
Hardness (mg/L as CaCO ₃)	Calcium and magnesium can compete with binding sites on ion exchange resins.
Alkalinity (mg/L as CaCO ₃)	Higher alkalinity waters require more chemical addition to adjust the pH if needed.
Ammonia (mg/L)	Ammonia can affect the treatment process if chlorine is used as an oxidant.
TOC (mg/L)	TOC can foul filter media, exert an oxidant demand, and lead to the formation of disinfection byproducts. TOC can affect treatment performance at 1.0 mg/L and be especially problematic at concentrations greater than 2.0 mg/L.
Temperature (°C)	Temperature can affect the kinetics of the treatment process. Usually not a significant factor.
pH	If air or chlorine are used as an oxidant, the oxidation of manganese is very slow at pH less than 8.0.

F.9.4 Pilot Testing

Pilot testing is usually necessary to determine whether a treatment process is functional and economically viable. It also helps engineers to develop the appropriate design parameters for the treatment process:

- A. Oxidant type, dose and contact time.
- B. Optimal pH and adjustment (if necessary).
- C. Filter media type, depth, and loading rate.
- D. Backwash frequency, duration, and hydraulic rate.
- E. Filter-to-waste duration and rate.
- F. Backwash recycle return (flow rate, volume per filter backwash cycle, quality) if applicable.
- G. Other process control parameters (if used) for parameters such as pH adjustment.

We recognize that many small systems installing Fe/Mn treatment may choose to skip the pilot test step and go straight to a full-scale design (see Section 10.3.5). Design engineers and water system owners who choose to skip the pilot study step do so at their own risk. Design engineers should discuss with the regional engineer their justification for skipping the pilot test step before proceeding to full scale design.

Adequate piloting provides greater assurance of treatment performance. At a basic level, the project report that summarizes the pilot test should describe:

- A. Pilot plant setup, duration (see Table 10-2) and results as they relate to full-scale treatment design.
- B. Pilot plant design parameters:
 - i. Treatment rate of the pilot plant (gpm/sq.ft.).
 - ii. Oxidant and dosage (mg/L), if applicable.
 - iii. Length of oxidation and coagulant contact times. Contact time is detention time from point of oxidation or coagulation addition to filter.
 - iv. Backwash parameters (filter run length/volume (hours or gals), backwash rate (gpm), duration (min)), and recycle return, if applicable.
 - v. pH adjustment, if necessary.

F.9.5 Summarize Oxidation-Filtration Treatment Components

Include schematic drawing of the treatment system identifying:

- A. Major system components

- B. Process control stations, such as water quality sampling points (raw, post-oxidant, after each filter, combined filter effluent) flow meter(s), pressure gauges, chlorine residual analyzer(s), turbidity meter(s)).

F.9.6 Full-Scale Design

The design engineer should cover the following items in the project report and construction documents:

- A. Process Control: Document location of and interaction between these process control components:
 - i. Sample locations:
 - a. Raw water (before any treatment).
 - b. After oxidant addition.
 - c. After each filter.
 - d. Combined filter effluent.
 - e. Backwash recycle return, if applicable.
 - ii. Physical parameter and water quality analysis:
 - a. Identify the frequency of monitoring for the flow, oxidant residual, pressure, and filtration volume or run time.
 - b. On-line or continuous water quality instrumentation can improve process control and aid in troubleshooting; so, you should evaluate the use of chlorine residual analyzers, pH analyzers, and turbidimeters.
 - iii. Process control narrative describing:
 - a. Process control parameters (oxidant residual, target pH), means of process control, and benchmarks for successful operations.
 - b. Capacity for remote operations.
 - c. Alarm and shutdown conditions.
- B. pH Adjustment: Document pH adjustment design basis, if applicable. Chemical used, dosage (mg/L), and target pH range.
- C. Oxidation: Document oxidation process design basis.
 - i. Oxidant type.
 - ii. Oxidant dose (mg/L).
 - iii. Target oxidant residual (mg/L).
If using ozone as an oxidant, see Appendix F.5 for submittal guidance.
 - iv. Contact Time (sec) between oxidant and filter.

D. Filter media

- i. Type, depth (usually at least 36 inches), effective size, and loading rate.
Filtration rate usually less than 5 gpm/sf for effective filtration though may be higher if raw water quality is suitable and if demonstrated through pilot testing.
- ii. Expected replacement frequency and sensitivity to oxidants.
- iii. ANSI/NSF Standard 61 certification.

E. Backwash: Document backwash design criteria and process.

- i. Describe design objective
 - a. Optimize finished water quality.
 - b. Minimize backwash volume per cycle.
 - c. Maximize finished water volume.
- ii. Identify backwash initiation
 - a. Head loss, psi or feet.
 - b. Time since last backwash, hours or days.
 - c. Volume of filtered water, gallons.
- iii. Identify backwash hydraulics:
 - a. Flow rate (gpm/sf). Identify the manufacturer's recommended backwash application rate in gpm/sq.ft.
 - b. Identify the backwash pump pressure in psi. Attach pump curve. Verify adequacy of system hydraulics for the proposed backwash.
 - c. Backwash duration, in minutes. We recommend a visual means of confirming adequacy of BW duration, such as a segment of clear pipe.
 - d. Volume, in gallons.
 - e. Verify that no cross connection exists between the backwash source water and the wastewater.
- iv. Backwash disposal
 - a. Volume of backwash per cycle, average day, and peak day volume of backwash.
 - b. Describe disposal of backwash, and include all backwash disposal facilities in construction documents.
 - c. Confirm that the proposed method of backwash waste disposal is acceptable to the Department of Ecology and the local health department. See Chapter 10 for guidance on permitting water treatment plant waste disposal.

- F. Backwash Recycle Return: Document backwash recycle return design basis, if applicable.
 - i. Backwash storage and return
 - a. Backwash holding tank volume, gallons.
 - b. Detention time, hours.
 - c. Supernatant recycle return volume, gallons.
 - d. Supernatant recycle return flow, gpm. The recycle return flow should not exceed 10 percent of the total influent to the filters.
 - ii. Conditioning supernatant recycle return
 - a. Bag/cartridge filter.
 - b. Chemical addition.
 - c. Turbidity monitoring of supernatant recycle return stream.
 - iii. Identify backwash recycle return initiation
 - a. Volume of backwash water, gallons
 - b. Time since last backwash recycle return, in hours or days. We recommend recycling on a volume basis rather than time because production varies throughout the year.
- G. System Hydraulics
 - i. Describe source-pumping mode (pumps directly to storage or to distribution).
 - ii. Define the current installed source pumping capacity in gpm.
 - iii. Verify that the installed pumping capacity is adequate to meet current design standards with the proposed treatment on line. Discuss all components of the total pumping head (well pump lift, system elevation difference, treatment plant head loss, system head losses, and residual pressure).

F.9.7 Operations and Maintenance

Prepare an O&M manual section:

- A. Identify maintenance personnel and operators.
- B. Outline routine daily, weekly, monthly, and annual inspection and maintenance.
- C. Identify major equipment components and their manufacturers.
- D. Identify a record keeping system to track treatment system performance.
- E. Disinfection byproduct monitoring plan if chlorine or ozone is used (does not apply to transient noncommunity systems).

- F. Identify the appropriate DOH monthly treatment plant report form. Obtain the applicable reporting form from your regional engineer.
- G. Confirm that the certified operator reviewed and had the opportunity for input on the design and O&M plan.
- H. Fe and Mn test kits in specifications.

Appendix F.10 Iron and Manganese Treatment by Sequestration

Sequestration by applying a polyphosphate enables soluble iron and manganese to remain in solution, even in the presence of an oxidant like chlorine. This process also is called stabilization, chelation, or dispersion. Water systems use it to preserve water's physical aesthetic by preventing the formation of particulate iron and manganese and its attendant turbidity. Sequestration does not remove iron or manganese, and will not re-suspend particulate iron or manganese back into their soluble form.

F.10.1 Design Limitations

Design engineers should recognize several limitations to sequestration.

- You should not use sequestration when the combined iron-manganese level exceeds 0.5 milligram per liter (mg/L). We will not approve sequestration if the combined iron-manganese level exceeds 1.0 mg/L, with the manganese at no more than 0.1 mg/l as Mn.
- Add sequestering agents, such as the polyphosphates (hexametaphosphate and trisodium phosphate), prior to any oxidation influence.
- Concentrations of polyphosphate cannot exceed 10 mg/L as PO₄ in the distribution system.
- The polyphosphate **must** be listed under ANSI/NSF Standard 60 and the dose must fall below the NSF-approved dose (WAC 246-290-220).
- Because polyphosphate is a bacterial nutrient and can lead to bacterial growth in distribution lines, industry standards dictate post-sequestration chlorine disinfection shall be provided and a detectable chlorine residual shall be maintained throughout the distribution system (Ten State Standards, 2012).
- Adding polyphosphate to the drinking water supply will increase the phosphate concentration in wastewater effluent. Design engineers should consult with the local wastewater treatment authority on the advisability of adding polyphosphate to the drinking water supply.
- Polyphosphates can increase lead solubility (Holm and Schock, 1991). For this reason, if polyphosphates are added to a water supply, additional tap sample monitoring under the Lead and Copper Rule will likely be required.
- To prevent oxidation of the iron or manganese before they stabilize, the system should add polyphosphate into the well near the suction side of the pump to minimize oxidation by aeration.
- The application point for the disinfectant should be more than 10 feet downstream of the pump discharge. The manufacturer's recommendations may require a greater distance.

- Sequestering agents are effective in cold water, but lose their capability in heated or boiled water. You should recognize that this form of treatment may not resolve customer concerns for hot water portions of domestic service.
- DOH will require installation of Fe/Mn removal treatment if we determine that sequestration is ineffective at mitigating aesthetic water quality issues.

F.10.2 Pilot Testing for Sequestering – Laboratory Bench Scale Tests

When considering sequestration for iron-manganese control, we recommend the following bench scale test* to determine the required dose of sequestering agent:

1. Treat a series of 1-liter samples with a standard chlorine solution to determine the chlorine dose required to produce the desired free chlorine residual. The minimum target free chlorine value should be 0.2 mg/L.
2. Prepare a standard sequestering agent solution by dissolving 1.0 gram of agent in a liter of distilled water in a volumetric flask.
3. Treat a separate series of five 1-liter samples with varying amounts of the sequestering agent. One milliliter (ml) of the standard sequestering agent solution (prepared as per step 2 above) is equivalent to a 0.1 percent solution. One ml of this stock solution in one liter of sample is equivalent to 8.34 pounds of sequestering agent per million gallons, equal to one part per million (ppm). Add 1, 2, 3, 4, and 5 ml dosages to the 1-liter samples and stir until the sequestering agent dose is well-mixed. Continue to stir while adding the previously determined chlorine dosage to avoid localized high chlorine concentrations.
4. Observe the series of treated samples against a white background to note the degree of discoloration. The proper dose of sequestering agent is the lowest dose that delays noticeable discoloration for a 4-day period. This dose cannot exceed 10 mg/L as PO₄ or the NSF-approved maximum dose for the polyphosphate sequestering agent (Ten State Standards, 2012).

* Use freshly collected samples for the bench test. Keep them away from direct sunlight to avoid heating, and maintained them at room temperature for the duration of the test.

Initial water quality testing should include:

Raw Water Quality Table

Water Quality Parameters	Comments
Ferrous Iron (Fe ⁺²) (mg/L)	Sequestration is not recommended when the concentration exceeds 0.5 mg/L.
Manganese (Mn ⁺²) (mg/L)	Sequestration is not recommended when the concentration exceeds 0.1 mg/L.
Hardness (mg/L as CaCO ₃)	Hardness ions (calcium and magnesium) can bind with the sequestering agent.
Alkalinity (mg/L as CaCO ₃)	Higher alkalinity waters require more chemical addition to adjust the pH if needed.
Temperature (°C)	Sequestering is not effective for hot water and the sequestering agent breaks down more rapidly in warm water, though temperature is usually not an issue for most groundwater supplies.
pH	Sequestering is more effective at a lower pH (less than 7.5) since iron and manganese are more readily oxidized at a higher pH.

F.10.3 Public Notification

The sequestration design submittal should include a public notification for distribution to consumers. The notification should inform consumers that they may still experience discoloration and particulate problems with the hot water portion of their home plumbing. In addition, advise customers located in more remote portions of the water distribution system that discoloration and particulate matter may still pose aesthetic problems if water in their portion of the distribution system is not routinely flushed.

F.10.4 Distribution System Related Problems

Occasionally, complaints about aesthetic concerns are not directly related to levels of iron or manganese in source water. Existing water systems should examine the nature of any consumer complaints to determine whether the problem is water source or distribution system related.

Corrosion within the distribution system may contribute to aesthetic problems at consumers' taps, including odor, particulate matter, or red, orange, or brown-colored water. Before initiating a sequestration design, the design engineer should find out whether the observed aesthetic problems result from distribution system corrosion. If you determine that distribution system corrosion is the problem, you should target

treatment options at ways to mitigate problems associated with water corrosivity (pH or alkalinity adjustment).

Recommended References

Great Lakes-Upper Mississippi River Board of State and Provincial Public Health and Environmental Managers. 2012. Ten State Standards - *Recommended Standards for Water Works*. Health Education Service, Albany, NY.

HDR Engineering, Inc. 2001. *Handbook of Public Water Supplies*, 2nd Edition, Chapter 14: "Iron and Manganese Removal," John Wiley & Sons, New York, NY.

Lytle, D.A. and Snoeyink, V.L. 2002. "Effect of Ortho- and Polyphosphates on the Properties of Iron Particles and Suspensions," *Journal AWWA*, Vol. 94, Issue 10, pp. 87-99.

Holm, T. R., and Schock, M. R. 1991. "Potential Effects of Polyphosphate Products on Lead Solubility in Plumbing Systems." *Journal AWWA*, Vol. 83, Issue 7, pp. 76-82.

Sommerfeld, E.O. 1999. *Iron and Manganese Removal Handbook*, AWWA, Denver, CO.

Appendix F.11 Nitrate Removal by Ion Exchange

Submittal Outline

This outline will guide and summarize the design of nitrate (NO₃) treatment facilities for small water systems using groundwater sources. Refer to Section 10.2.5 and [DOH 331-309](#) for additional guidance.

In Washington, ion exchange is the most common treatment process used to remove nitrate from drinking water. The following factors are important in the successful, reliable operation of a nitrate removal treatment facility using ion exchange.

- Complete and accurate raw water data at time of design, including an understanding of seasonal changes in raw water quality.
- Clearly defined O&M practices and clearly defined role of the operator to fulfill O&M responsibilities.

An engineer licensed in Washington must prepare all submittals for treatment facilities. All supporting documentation **must** be included with the design submittal (WAC 246-290-110).

F.11.1 General Water System Information

Provide the following general information:

- A. Water system name and public water system identification number.
- B. Owner's name, address, and telephone number.
- C. Manager's name, address, and telephone number.
- D. Operator's name, certification level, and telephone number.
- E. Completed (preliminary) [Purification Plant Criteria Worksheet](#) (include all existing and proposed treatment processes).
- F. Completed [Project Approval Application Form](#) (DOH 331-149-F).

F.11.2 Description of the Water Quality Problem

Describe the source of supply and the purpose and goals of the treatment proposed. Include source number and design flow rate(s).

F.11.3 Raw Water Quality

The raw water quality is critical when determining whether ion exchange is an appropriate treatment process, sizing equipment, and selecting resin. It will determine brine regeneration frequency, waste volume generated, and the need for post-ion exchange pH adjustment or corrosion control. You should pilot test nitrate ion exchange

treatment facilities at the site, capturing raw water seasonal variability. You should perform some other raw-water quality tests on site, too.

The raw water quality of most groundwater supplies vary seasonally and over time. For this reason, you should collect at least two separate samples for the parameters listed below, capturing seasonal changes in water quality. In aquifers where the water quality is known to vary significantly, such as some island aquifers, we recommend additional raw water quality sampling. To get accurate data, a qualified person must measure temperature, ferrous iron, and pH at the well site (not in a lab). A laboratory certified for drinking water **must** analyze all other water quality parameters (WAC 246-290-300(1)(c)). Submit all lab data sheets to DOH.

Raw Water Quality Table

Water Quality Parameters	Comment
Nitrate (mg/L)	The concentration of nitrate and how much it varies seasonally affects the design of the treatment process
Total Organic Carbon (mg/L)	TOC can foul ion exchange resins and compete for adsorptive sites on the resin. Pretreatment for TOC removal may be necessary, especially if the TOC concentration exceeds 2.0 mg/L.
pH	Anion exchange can cause a significant drop in pH, making the water more corrosive.
Sulfate (mg/L)	Sulfate competes with nitrate for binding with the ion exchange resin, creating the need for more frequent regeneration.
Iron (mg/L)	Iron can foul ion exchange resins, so pretreatment may be required if the combined concentration of iron and manganese exceeds 0.1 mg/L.
Manganese (mg/L)	Manganese can foul ion exchange resins, so pretreatment may be required if the combined concentration of iron and manganese exceeds 0.1 mg/L.
Alkalinity (mg/L as CaCO ₃)	Anion exchange removes carbonate from the water, which decreases the pH and dissolved inorganic carbon, and usually makes the water more corrosive.
Hardness (mg/L as CaCO ₃)	High hardness can lead to mineral precipitation, thereby fouling the ion exchange resin.
TDS (mg/L)	A useful general parameter for assessing the potential for competition and fouling of the resin.
Turbidity (NTU)	High turbidity can foul the resin leading to increased head loss and the need for more frequent regeneration.

F.11.4 Pilot Testing

Pilot testing is necessary to determine whether a treatment process will be functional and economically viable. It helps engineers develop the appropriate full-scale plant design parameters, including:

- A. Need for pretreatment, such as softening or prefiltration.
- B. Need for posttreatment pH adjustment.
- C. Resin type.
- D. Resin bed volume.
- E. Flow rate.
- F. Empty bed contact time.
- G. Process control to start regeneration cycle.

If the design engineer does not conduct a pilot test, they should submit at least two complete sets of raw water sample results reflecting seasonal variability to the ion exchange equipment manufacturer. Ask the equipment manufacturer for a written assessment of removal efficiency, treatment capacity (volume), and salt use between regeneration cycles.

- H. Describe the pilot plant setup, duration (see Table 10-2), and results as they relate to full-scale treatment design.
- I. For each resin type tested, describe pilot plant test results including:
 - i. Bed volume.
 - ii. Surface loading rate through the reactor.
 - iii. Raw and treated water nitrate concentration, pH, and sodium concentration.
 - iv. Bed volumes treated before regeneration.
 - v. Predicted waste volume (sum of backwash and rinse, including softener if applicable) expressed as a percent of water treated during the previous exchange cycle.
 - vi. Predicted salt use per gallon of water treated during exchange cycle (including softener, if applicable).
- J. Describe how long the pilot plant operated. Explain the seasonal water quality changes that may affect the performance of the proposed treatment plant or require operational adjustments.

F.11.5 Summarize Ion Exchange Treatment Components

Include a schematic drawing of the treatment system identifying:

- A. Major system components.

- i. We recommend redundant treatment facilities for sole-source drinking water supplies.
 - ii. Pretreatment softening and/or filtration, if needed.
 - iii. We recommend providing a treated water storage reservoir with a volume equal to the average daily demand. Located prior to entry to the distribution system, the storage reservoir can serve as a buffer between an undetected treatment failure and consumers, prevent some nitrate MCL violations, and provide a source of water for backwashing and rinsing.
 - iv. Posttreatment corrosion control and/or pH adjustment (if needed).
- B. Process control, such as water quality sampling points, flow meter(s), clock, pressure gauges, in-line analyzer(s).

F.11.6 Full-Scale Design

- A. Process Control: Document location of and interaction between these process control components:
- i. Sampling taps:
 - a. Raw and treated water.
 - b. Blending point (if treated and untreated water blends before entering distribution).
 - ii. Water quality analysis:
 - a. Nitrate.
 - b. pH.
 - iii. Other process control parameters:
 - a. Flow rate.
 - b. Volume treated.
 - c. Pressure.
 - d. Time.
 - iv. Process control narrative describing:
 - a. Process control parameters (time, volume, nitrate concentration, pH), means of process control, and benchmarks for successful operations.
 - b. Capacity for remote operations.
 - c. Alarm and shutdown conditions.
- B. Treatment Process.
- i. Prefiltration.

- ii. Softening prior to nitrate ion exchange.
 - iii. Resin tanks.
 - a. Number of tanks.
 - b. Flow path (series or parallel).
 - c. Total resin bed area (sq. ft.).
 - d. Loading rate (gpm per sq. ft.).
 - e. Resin depth (ft.).
 - f. Empty bed contact time (EBCT, in minutes).
 - iv. Resins
 - a. Resin type, trade name, and manufacturer.
 - b. Manufacturer's published removal efficacy based on raw water quality parameters.
 - c. Manufacturer's published limitations of use (e.g., pressure, loading rate, raw water quality, chlorine).
 - d. NSF 61 certification.
 - e. Life expectancy (e.g., number of regeneration cycles) and assumed decline in resin efficiency during each year of operation.
- C. Backwash/Regeneration: Document backwash design criteria and process.
- i. Identify backwash initiation:
 - a. Time since last backwash, hours or days.
 - b. Volume of filtered water, gallons.
 - ii. Identify backwash hydraulics:
 - a. Flow rate (gpm/sf). Identify the manufacturer's recommended backwash application rate in gpm/sq. ft.
 - b. Identify the backwash pump pressure in psi. Attach pump curve. Verify adequacy of system hydraulics for the proposed backwash.
 - c. Backwash duration, minutes.
 - d. Volume.
 - e. Verify that no cross connection exists between the backwash source water and the wastewater.
 - iii. Backwash or Brine Rinse disposal (include softener if applicable):
 - a. Describe constituents, average day, and peak day volume of backwash.
 - b. Calculate average daily salt disposal (lbs/day).

- c. Describe disposal of backwash, and include all backwash disposal facilities in construction documents.
- d. Confirm that the proposed method of backwash waste disposal is acceptable to the Department of Ecology and the local health department. See Chapter 10 for guidance on permitting water treatment plant waste disposal.

D. System Hydraulics

- i. Describe source-pumping mode (pumps directly to storage or to distribution).
- ii. Define the current installed source pumping capacity in gpm.
- iii. Verify that the installed pumping capacity is adequate to meet current design standards with the proposed treatment on line. Discuss all components of the total pumping head (well pump lift, system elevation difference, treatment plant head loss, system head losses, and residual pressure).

E. Corrosion Control

Assess the corrosivity of the treated drinking water supply.

F.11.7 Operations and Maintenance

Prepare an O&M manual section:

- A. Identify maintenance personnel and operators.
- B. Outline routine daily, weekly, monthly, and annual sampling, inspection and maintenance.
- C. Identify major equipment components and their manufacturers.
- D. Identify a record keeping system to track treatment system performance.
- E. Confirm that the certified operator reviewed and had the opportunity for input on the design and O&M plan.

Appendix G: Guidance for Leachable Contaminants Testing

Engineers can now use the “leachable contaminants test” (a.k.a. “soak test”) to better identify and address contamination from leachable components when they bring new facilities on-line. Engineers use this test predominately when there is some question about the “quality of workmanship” associated with facility installation, or with materials that would be in substantial contact with drinking water.

If the initial use of a facility presents, or could present, a water quality concern (for example, storage reservoirs primarily, but could include other facilities), DOH can require the water system to test the water before initiating service to consumers (see Section 7.6.2).

Authority for such monitoring comes from WAC 246-290-300 (1)(a)(i) if contamination is, or could be, suspected in the water system. For example, suspicion over contractor workmanship, illicit materials used, vandalism, or any number of reasons that would suggest the need to ensure appropriate water quality before using a facility in contact with the water to be provided.

For the various structures that may be of concern (usually new or recoated storage facilities, and some treatment facilities), testing of the water quality should be performed under defined protocols before putting those structures into service. We outline the concerns that could be associated with various projects and the recommended procedures for conducting leachable components tests below.

Concern Associated with Paints and Coatings

There may be concerns about organic chemical contamination resulting from improper selection or application of paint coatings used for water storage facilities. Experience shows that leaching of the coating materials sometimes elevates the level of organic contaminants found in drinking water. This may lead to taste and odor problems or, possibly, health concerns.

Because it is difficult to correct coating problems after you discover them, you should take considerable care in selecting and applying coating materials. If testing detects contamination above a maximum contaminant level (MCL), you **must not** place the storage facility into service until you reduce contamination to levels below the MCL (WAC 246-290-320).

Here are some precautions:

1. Use only coating products that meet ANSI/NSF Standard 61 for potable water surfaces (see WAC 246-290-220).
2. Only experienced and competent applicators should apply the coatings. They should closely follow the coating manufacturer's recommendations, particularly for ventilation and curing. For forced-air curing, the air should draw from the lowest part of the tank because many volatile organic vapors are heavier than air. If there is any doubt about the adequacy of the curing conditions, we suggest additional curing time with continued forced air ventilation. Experience shows that the manufacturer's suggested curing time is adequate only under the optimal conditions the manufacturer specifies. Longer curing periods are needed if temperature and humidity parameters are not optimal. After the curing period, you **must** clean and disinfect the tank before filling (WAC 246-290-451).

Concern Associated with Concrete Construction

Some petroleum-based form-release agents used to construct concrete water storage facilities can be a source of organic contamination. Concerns about contamination may result from the improper selection and use of fuel oil or lubricating oil as form-release agents. Special precautions are needed to minimize the hazards associated with use of these materials.

If these products were used, or if you suspect or find contamination, the storage facility **must not** be placed into service until the contamination is reduced to acceptable levels (see WAC 246-290-300).

Because it is difficult to remove all traces of petroleum contaminant from concrete, you should exercise considerable care in selecting, thinning, and using form-release materials. Some important precautions:

1. Clean forms prior to use.
2. Use only form-release agents that meet ANSI/NSF Standard 60, **OR**, in some instances, food-grade vegetable oils, for potable water contact surfaces (see WAC 246-290-220).
3. Use only ANSI/NSF Standard 60 approved materials or food-grade vegetable oils to thin form-release agents.

Following the curing period, you **must** wash and disinfect the tank before filling (WAC 246-290-451).

Concern Associated with Treatment Unit Media or Membranes (Alternate Technologies)

We may approve natural filter sand, gravel, anthracite, ilmenite and garnet if they were tested for leachable contaminants before they were placed into service.

This applies particularly to native mineral products, which are subjected only to mechanical processing, such as crushing, screening, and washing.

Vehicles used to transport filter media could be a significant source of contamination. Because it is difficult to remove all traces of contamination from media after you discover it, you should exercise considerable care while processing and transporting filter media. Some important precautions:

1. Clean potential contaminating substances from vehicles before using them to transport media.
2. Following media placement, wash, disinfect (slow sand filters excepted), rinse and test treatment units for coliform bacteria density before placing them into service.

Leachable Contaminant Testing Procedure

Whenever the water contact surfaces of a storage facility have been coated, or whenever "Leachable Contaminant Testing" is considered appropriate for any type of project, we will direct water systems to take the following steps before putting the facility into service:

Following a period of immersion or contact time, water in the tank, vessel, basin, or treatment unit (hereafter termed, "contact facility") must be sampled to determine the level of any leached chemicals. Although negotiable, the recommended contact period with the water is seven days for storage tank surface and 24 hours for filter media. The minimum immersion contact period should be at least equal, but preferably exceed the maximum anticipated operating detention times under normal operations. The operator should try to maximize the ratio of the wetted surface contact area to the volume of water in the tank. This suggests that the tank does not need to be filled completely to the overflow level because the area-to-volume ratio continually diminishes as a circular, rectangular, or square tank is filled. However, we recommend using at least 10 to 20 percent of the tank volume for testing. There should be enough water in the contact facility to account for all contact surfaces where "quality of installation or materials handling" is a concern. A Department of Ecology-certified laboratory must analyze samples of the water collected after the appropriate contact period. The analyses should

include contaminants that the material being evaluated could reasonably be assumed to contribute to potable water. Test methods may include, but are not limited to:

- Complete inorganic chemical (IOC) analysis.
- Volatile organic chemical (VOC) analysis.
- General synthetic organic chemical (SOC) analysis*, including phthalates and polycyclic aromatic hydrocarbons.
- Phthalates.

*The SOC test is primarily for pesticides. You need only consider this test if there are concerns over possible pesticide contamination. For example, it could be a concern if the material was transported or stored in a way that would expose it to SOCs.

The minimum analytes required for some particular situations are:

- a. For storage facilities having organic coatings, such as paints and sealants, the sample should be analyzed for VOCs. If the product contains phthalates, that parameter should also be analyzed.
- b. For concrete construction, the sample should be analyzed for VOCs and polynuclear aromatic hydrocarbons.
- c. For polyethylene, PVC, hypalon, or other flexible-material type storage facilities where fabrication involves solvents and glues, the sample should be analyzed for VOCs and phthalates.
- d. For filter media, including occlusion-type alternate technology filters, the sample should be analyzed for VOCs and regulated IOCs.

When reporting the test results to us, identify the sample purpose on the *Water Sampling Information sheet* as "Investigative." This will ensure that we don't treat the test results—particularly those with detections—as compliance samples under the source monitoring requirements. You should submit a copy of the test results directly to the DOH regional engineer reviewing the project.

Before delivering water from a storage facility to consumers, the water system must evaluate test results for compliance with the current maximum contaminant levels (MCLs). DOH will not allow any storage facility or treatment component to be placed into service, or remain in service, if using it would, or could be expected to, deliver public drinking water that contains any contaminant(s) exceeding any current MCL.

If testing reveals contaminants above DOH's monitoring trigger levels, but below MCLs, the water system should collect additional samples at least quarterly. Such monitoring

will remain in place until we determine test results are reliably and consistently below the MCL.

The source susceptibility rating will not change as long as testing shows the source of contamination is independent of the source water quality.

We **may** advise retesting, testing for additional analytes, or both when the lab detects contamination exceeding the method detection limit.

Appendix H: Slow Sand Filtration

Submittal Outline

This outline supplements the design guidance for slow sand filtration provided in Chapter 10 and 11, and in Appendix A.3.8.

Provide the following general information:

- A. Water system name and public water system identification number
- B. Owner's name, address, and telephone number
- C. Manager's name, address, and telephone number
- D. Operator's name, certification level, and telephone number
- E. Completed (preliminary) [Purification Plant Criteria Worksheet](#) (include all existing and proposed treatment processes)
- F. Completed [Project Approval Application Form](#) (DOH 331-149-F)

I. Pilot Plant Testing

Inadequate pilot testing has resulted in treatment process failures, delayed implementation of effective treatment, and required costly replacement of inadequate treatment. For those reasons, we require engineers to pilot test plants, and to submit a pilot testing plan to us. At a basic level, the project report that summarizes the pilot testing should describe:

- A. Pilot plant setup, duration and results as they relate to full-scale treatment design.
- B. Pilot plant design parameters:
 - i. Pretreatment (if any).
 - ii. Effects of seasonal water quality changes.
 - iii. Treatment rate of the pilot plant (gpm/sq.ft.).
 - iv. Sand specification and depth.
 - v. Support gravel specification and depth.
 - vi. Terminal head loss.

II. Design Guidance

Based on pilot testing results, the design **must** consider the following (WAC 246-290-110):

- A. Suitability of slow sand filtration for the available raw water supply.
- B. Potential for, and evaluation of, pretreatment needs.

- C. Effect of seasonal water quality changes.
- D. Suitability of specific filter sand and support gravels intended to be used.
- E. Performance demonstrated at proposed hydraulic loading rate.
- F. Length of time needed to commission (ripen) a new filter.
- G. Rate of head loss development and length of time between filter scrapings.
- H. Ripening time and proposed ripening indicators (turbidity, coliform counts, time, etc.).

III. Other Design Guidance

Address the following in the project report and construction documents:

- A. Filter effluent rates (hydraulic loading rates (HLR)) **must** not exceed 0.10 gpm/ft² (0.24 m/hr) (WAC 246-290-654).
 - a. For cold temperatures (water temperatures less than 5°C), we recommend a flow rate no higher than 0.05 gpm/ft².
 - b. Warmer temperatures may need higher filtration rates (up to 0.10 gpm/ft² maximum) to maintain adequate dissolved oxygen (D.O. >6 mg/l) within the schmutzdecke. Under low D.O. conditions, metals can be mobilized.
 - c. Effect of cold-water temperatures on performance and need for covering or other mitigation for freezing weather.

- B. Filtration area and number of filters needed to meet system demand, including during cleaning or ripening.

Provide at least two filter beds, with each filter capable of meeting peak day demands. If you use more than two filters, the system should be able to meet maximum day demands with the largest filter out of service.

- C. Optimal flow control strategy.

Ensure design provides for continuous operation without significant filter effluent flow-rate variation. Any filter effluent flow variations assumed in the design should be gradual to limit detachment of particles from the sand, with less than 50 percent flow change in any 24-hour period.

- D. Filter-to-waste and filter backfilling capabilities.

Provide filter-to-waste, or return the filter effluent to the headwater when system demands are low. Intermittent or ON/OFF operation should not be used as a means of rate control.

- E. Cleaning frequency and most appropriate method(s). If scraping is the intended filter cleaning method:

- a. Sand quantity removed annually through scraping or cleanings, and duration between re-sanding.
 - b. Address removal, handling, cleaning and stockpiling arrangements for scraped sand.
 - c. Consider allowing scraped sand to be washed and stored on-site, so you can reuse it. Storage area should be covered, and protected from contamination.
- F. Assessment of appropriate automation and supervisory control and data acquisition (SCADA) systems.
- G. Operator time needed for normal operations, monitoring, reporting and maintenance tasks

IV. Checklist of Additional Items

- A. Influent water should be introduced to the supernatant water with enough clearance above the sand (at least 12 inches) to prevent turbulence scouring. Energy dissipating structures may also be used to prevent sand scour.
- B. To prevent air binding within the filter, the system needs to maintain the filtered water elevation at or above the sand bed level. An effluent weir is a simple and effective way to maintain adequate water depth.
- C. Considerations for improved safety and ease of operations:
 - a. Avoid confined space entry.
 - b. Provide adequate headspace.
 - c. Eliminate trip hazards.
 - d. Prevent situations that might make maintenance activities more difficult.

V. Operations and Maintenance

During the design phase, engineers should draft operations and maintenance manuals, procedures for monitoring and collecting data, and procedures for recording and reporting data. They will facilitate an understanding of how staff will operate the plant and monitor filter performance. You should consult operations staff early in the design phase and encourage them to visit other slow sand plants.

Designers and operations staff should conduct tabletop exercises for start-up, normal operations, and cleaning procedures. They will identify design-related operational problems so the engineer can correct them prior to construction.

Develop an O&M manual and submit it to DOH:

- A. Identify maintenance personnel and operators.

- B. Outline routine daily, weekly, monthly, and annual inspection and maintenance. Include specific design criteria and specifications that trigger certain O&M activities, such as re-sanding or scraping filters.
- C. Identify major equipment components and their manufacturers.
- D. Identify a record keeping system to track treatment system performance.
- E. Identify the appropriate DOH monthly treatment plant report form. Obtain the applicable reporting form from our regional engineer.
- F. Confirm that the certified operator reviewed and had the opportunity for input on the design and O&M plan.

Recommended Slow Sand Filter General Plant Layout

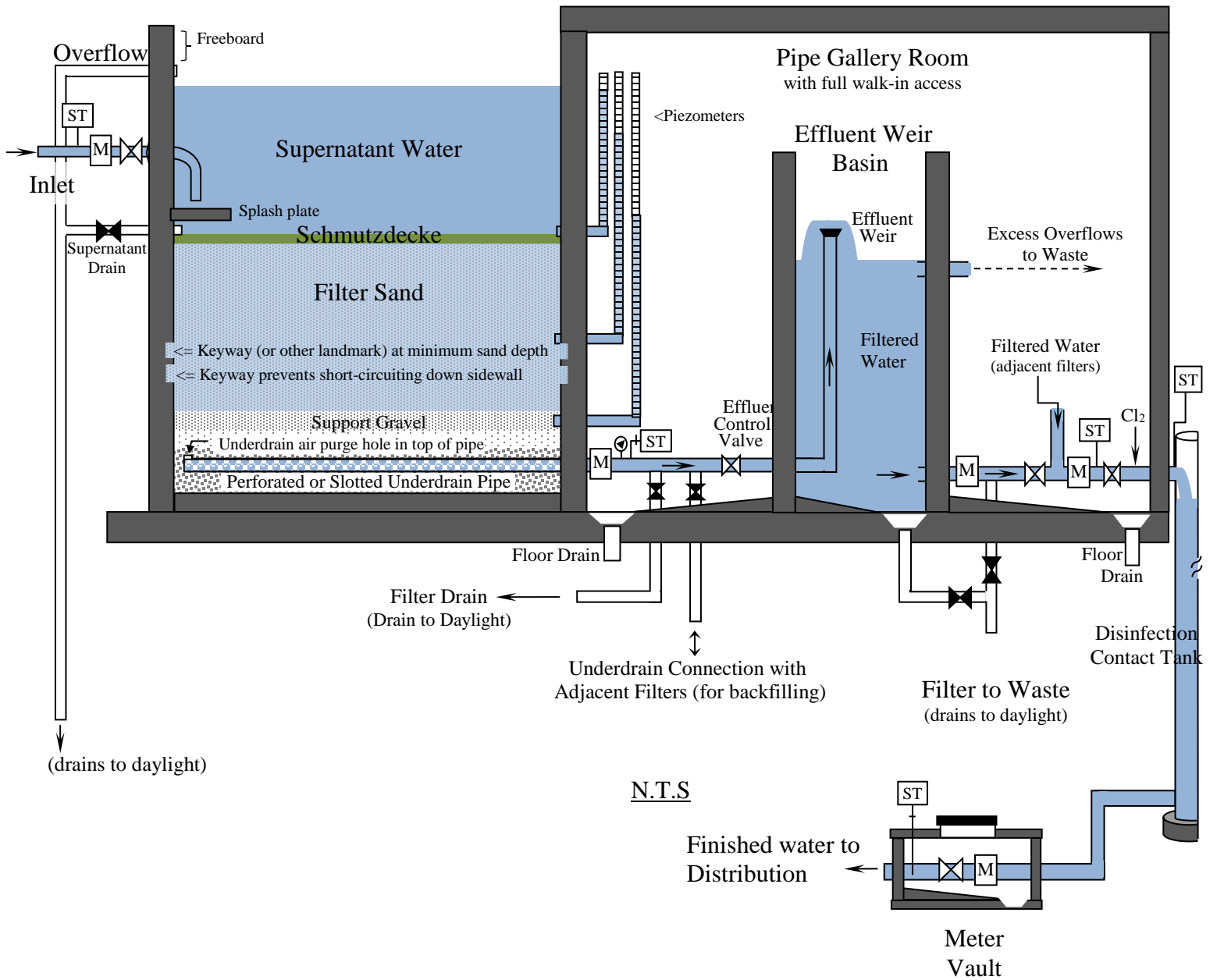

- | | |
|-----|---|
| M | - Meter |
| ST | - Sample Tap |
| ST1 | - Raw Water monitoring point – turbidity, coliform |
| ST2 | - Individual Filter Effluent (IFE) monitoring – turbidity, coliform |
| ST3 | - Combined Filter Effluent (CFE) turbidity monitoring point |
| ST4 | - Distribution Entry Point monitoring for chlorine, temp, and pH |
| ◼ | - Valve: normally closed (NC) |
| ⊗ | - Valve: normally open (NO) |

**Recommended Raw Water Quality Limits
following roughing filtration pretreatment, if present**

Parameter	Limit	Notes
Turbidity	< 10 NTU (colloidal clays are absent)	Operation is more efficient with lower, consistent turbidity in the 5–10 NTU range. Most slow sand plants successfully treat water (after any pretreatment such as roughing filters if applicable) with a turbidity of less than 10 NTU (Slezak and Sims, 1984), which is recommended for an upper limit in designing new facilities. Colloidal clays may penetrate deeper into the filter bed causing higher effluent turbidity and may cause long-term filter clogging. Roughing filters can provide up to 50–90% of turbidity removal (Wegelin et al., 1996).
True Color	< 5 platinum color units	The source of color should be determined. Color from iron or manganese may be more effectively removed than color from organics. True color removals of 25% or less were reported by Cleasby et al. (1984). The point of consumer complaints about water aesthetics is variable over a range from 5 to 30 color units, though most people find color objectionable over 15 color units (USEPA, 1999). The Secondary Maximum Contaminant Levels (SMCL) for color is 15 color units, which is also identified as a maximum level for slow sand filtration under the <i>Recommended Standards for Water Works</i> , 2012 Edition. Preozonation or granular activated carbon may be used to reduce color.
Coliform Bacteria	< 800/100 ml (CFU or MPN)	Coliform removals through slow sand filters range from 1 to 3-log (90–99.9%) (Collins, M.R. 1998).
Dissolved Oxygen (DO)	> 6 mg/l	Dissolved oxygen is critical for maintaining a healthy schmutzdecke for proper filtration. Potential problems resulting from low DO include tastes and odors, dissolution of precipitated metals such as iron and manganese, and increased chlorine demand (Ellis, 1985). Aim for a filtered water DO at or above 3 mg/l.
Total Organic Carbon (TOC)	< 3.0 mg/l (low TOC prevents DBP issues)	Recommendations for dissolved organic carbon (DOC) concentrations range from < 2.5–3.0 mg/l to minimize the formation of disinfection byproducts (DBPs) in the finished water. DOC removal in slow sand filters is < 15–25% (Collins, M.R. 1989). About 90% of TOC is DOC (USEPA, 1999). Total organic carbon (TOC) removal is variable and may range from 10–25% (Collins et. al, 1989; Fox et al, 1984). Determining DBP formation potential may provide more information by simulating DBP formation in the distribution system due to disinfectants added in the presence of organics.
Iron & Manganese	Each < 1 mg/l	Slow sand filters remove iron and manganese by precipitation at the sand surface. This can enhance organics removal, but too much iron and manganese precipitate can clog the filters. The Secondary Maximum Contaminant Level (SMCL) for iron is 0.3 mg/l and the SMCL for manganese is 0.05 mg/l. Iron and manganese removal in a slow sand filter can be > 67% (Collins, M.R. 1998).
Algae	< 200,000 cells/L (depends upon type)	By providing greater surface area for particle removal, certain types of filamentous algae may enhance biological activity and be beneficial for filtration, but in general, the presence of algae reduces filter run length. Filter clogging species are detrimental to filtration and the presence of floating species may shorten filter run length due to the associated poorer-quality raw water (see the table below for common algal species). Microscopic identification and enumeration is recommended to determine algae species and concentration.

Classification of Common Algal Species¹

Filter Clogging ²	Filamentous	Floating
Tabellaria Asterionella Stephanodiscus Synedra	Hydrodictyon Oscillatoria ³ Cladophora Aphanizomenon Melosira	Protococcus Scenedesmus Synura Anaaoenas ³ Euglena

Notes:

¹Table adapted from Table 10.2, Water Treatment Plant Design, AWWA/ASCE/EWRI, 2012.

²Diatoms of all species can generally can cause clogging due to their rigid inorganic shells.

³Can also release algal toxins (Microcystin and Anatoxin-a, among others).

Filter Sand Specification: Recommended Range

Parameter	Limit
Effective Diameter (d10)	0.2 – 0.35 mm (No. 70 Sieve = 0.212 mm; No. 45 Sieve = 0.355 mm)
Uniformity Coefficient (UC)	1.5 – 3.0
% Fines passing #200 sieve (75 µm)	< 0.3% by Wt.
Acid Solubility	< 5%
Apparent Specific Gravity	≥ 2.55
Sand bed depth, initial	> 31 inches > 36 inches is recommended to allow for a sufficient number of scrapings before re-sanding is needed
Minimum operating sand bed depth prior to re-sanding. This minimum sand bed depth is in addition to the amount of sand anticipated to be removed due to cleanings throughout the life of the filter.	19 inches A horizontal keyway incorporated into the walls along the entire perimeter of the filter with the bottom of the keyway at the 19-inch level serves the dual purpose of indicating the absolute minimum sand bed depth while preventing raw water from seeping down the side walls of the filter to the under drains. A second keyway or scribe mark situated at the 21 to 23-inch level can indicate when the bed is approaching the minimum level.

Delivery/Installation

Sand should be washed thoroughly to remove deleterious materials like clay fines and organics prior to placement. Keep sand clean and store it only on a clean, hard, dry,

covered surface until placement. Refer to ANSI/AWWA Standard B100-16 or latest revision for additional storage and handling information.

Underdrain Design Parameters: Recommended Specification

Parameter	Limit	Notes
Maximum velocity in main drain	0.75 fps (0.23 m/sec)	The <i>Recommended Standards for Water Works</i> (Ten States Standards, 2012), say each filter should be equipped with a main drain and an adequate number of lateral underdrains to collect the filtered water.
Maximum velocity in laterals	0.75 fps (0.23 m/sec)	Underdrains should be placed as close to the floor as possible and spaced so that the maximum velocity of the water flow in the underdrain will not exceed the value stated.
Spacing of lateral drain pipes	36 inches (91.4 cm)	Although spacing lateral drains up to 79" (2 m) may be satisfactory due to the low hydraulic resistance in the support gravel, smaller spacing increases the uniformity of flow through the drains (Hendricks, et al., 1991, p. 112). Recommended maximum lateral spacing from Ten States Standards, 2012.
Spacing of bottom lateral drain holes	4–12 inches (0.1–0.3 m) Placed as close to the filter floor as possible and secured in place to prevent movement.	The underdrain system should ensure uniform flow through the overlying sand bed. Achieve this by having a uniform distribution and sufficient number of collection orifices and designing the ratio of the orifice area/conduit (pipe) area such that the head loss within the underdrain pipe is negligible relative to the orifice (Hendricks, et al., 1991, p. 108). This yields a head loss through the drain holes much greater than the head loss in the laterals and main drains to ensure the even flow distribution. The diameter and spacing of the underdrain pipes and the diameter of the orifices should be determined theoretically by hydraulic calculations.
Diameter of drain holes	¼-inch (6.35 mm)	Include air release holes or slits at the top near the midpoint of the main drain and each lateral. Alternatively, slotted drainpipe may be used where the width of the slots is in the 5/64" to 5/32" (2-4 mm) range, provided the head loss through the slots is determined to be much greater than the laterals and main drains.
Material	PVC or other noncorrosive material meeting ANSI/NSF Standard 61)	

Support Gravel

Support gravel should conform to published design guidelines (see endnote references, below). An example of a 5-layer support gravel system is provided for filter sand with an effective size of 0.2 mm to 0.35 mm using design guidelines from Appendix D of ANSI/AWWA Standard B100-16 and commercially available gravel sizes according to standard sieve sizes under ASTM E11-13. The gravel support using 5 layers as shown below will work if the orifices in the under drain pipe are less than or equal to 1/4" in diameter. 4 layers are adequate with 1/8" (3.175 mm) diameter drain orifices and a bottom gravel layer of 1/2" x 1/4" (12.7 x 6.35 mm).

Support Media ¹	Passing Screen Size (largest particle) ²	Retaining Screen Size (smallest particle) ²	Depth of Layer ³	Criteria (The actual ratio demonstrating how well the criteria has been met is provided in parentheses)
Layer 1 - Top Layer ("very coarse" sand)	No. 10 Sieve (2 mm)	No. 20 Sieve (0.85 mm)	3 inches (76.2 mm)	Within Layer 1: The largest particle size in layer 1 is less than or equal to 2 times the size of the smallest particle size in layer 1. (2.4) Between Layer 1 and the Filter Sand: The smallest particle size in layer 1 is between 4 and 4.5 times the smallest effective size of the filter sand. (4.2)
Layer 2 (No. 6 Sieve x No. 12 Sieve)	No. 6 Sieve (3.35 mm)	No. 12 Sieve (1.7 mm)	3 inches (76.2 mm)	Within Layer 2: The largest particle size in layer 2 is less than or equal to 2 times the size of the smallest particle size in layer 2. (2.0) Between Layers 1 and 2: The largest particle size in layer 2 is less than or equal to 4 times the smallest particle size in layer 1. (3.9)
Layer 3 (1/4" x No. 6 Sieve)	1/4" (6.3 mm)	No. 6 Sieve (3.35 mm)	3 inches (76.2 mm)	Within Layer 3: The largest particle size in layer 3 is less than or equal to 2 times the smallest particle size in layer 3. (1.9) Between Layers 2 and 3: The largest particle size in layer 3 is less than or equal to 4 times the smallest particle size in layer 2. (3.7)
Layer 4 (1/2" x 1/4")	1/2" (12.5 mm)	1/4" (6.3 mm)	3 inches (76.2 mm)	Within Layer 4: The largest particle size in layer 4 is less than or equal to 2 times the smallest particle size in layer 4. (2.0) Between Layers 3 and 4: The largest particle size in layer 4 is less than or equal to 4 times the smallest particle size in layer 3. (3.7)

Layer 5 - Bottom Layer (3/4" x 1/2")	3/4" (19.0 mm)	1/2" (12.5 mm)	3 inches minimum and such that the gravel completely surrounds and provides for at least 1" (25.4 mm) of cover over the laterals and main drain to provide for a level surface for upper gravel layers	Within Layer 5: The largest particle size in layer 5 is less than or equal to 2 times the size of the smallest particle size in layer 5. (1.5) Between Layers 4 and 5: The largest particle size in layer 5 is less than or equal to 4 times the smallest particle size in layer 4. (3.0) Between Layer 5 and the Underdrain: The smallest particle size in layer 5 is at least twice the size of the underdrain orifice size. (2.0)
--	-------------------	-------------------	--	--

Delivery/Installation

Support media should be washed thoroughly to remove deleterious materials like clay fines and organics prior to placement. Keep media clean and only store on a clean, hard, dry, covered surface until placement. Refer to ANSI/AWWA Standard B100-16 or latest revision for additional storage and handling information.

Footnotes

¹Refer to ANSI/AWWA Standard B100-16 or latest revision for more detailed specifications.

²No more than 8% by dry weight of particles should be greater than the passing screen size and no more than 8% by dry weight of particles should be smaller than the retaining screen size.

³The thickness of each layer of support gravel should be at least 3 times the diameter of the largest particles. For practical reasons, the thickness of each layer should be 2-3 inches for coarse sand and gravel up to 1/2" (12.7 mm) in size. Keep gravel clean and only store on a clean, hard, dry, covered surface until placement. Gravel should be washed thoroughly to remove deleterious materials like clay fines and organics prior to placement. Layers should be placed to a uniform thickness, leveled, and washed in succession according to ANSI/AWWA Standard B100.

References

- ASTM. 2013. *E11 Standard Specification for Woven Wire Test Sieve Cloth and Test Sieves*. American Society for Testing Materials. West Conshohocken, PA.
- AWWA and American Society of Civil Engineers (ASCE). 2012. *Water Treatment Plant Design*, 5th Edition, Chapter 10 "Slow Sand and Diatomaceous Earth Filtration". McGraw-Hill. New York, NY.
- AWWA. 2016. *B100 AWWA Standard for Granular Filter Media*. American Water Works Association, Denver, CO.
- Cleasby, J. L., Hilmoie, D. J., & Dimitracopoulos, C. J. 1984. Slow sand and direct in-line filtration of a surface water. *Journal AWWA*, Vol. 76. No. 12. pp. 44-55.
- Collins, M.R. 1998. *Slow Sand Filtration – Tech Brief*. National Drinking Water Clearing House Fact Sheet 14.
- Collins, M.R., T.T. Eighmy, J.M. Fenstermacher, and S.K. Spanos. 1989. *Modifications to the Slow Sand Filtration Process for Improved Removals of Trihalomethane Precursors*. AWWA Research Foundation Report.
- Ellis, K.V. 1985. Slow Sand Filtration. *CRC Critical Reviews in Environmental Control*. Vol. 15, Issue 4, pp. 315-354.
- Fox, K. R., Miltner, R. J., Logsdon, G. S., Dicks, D. L., & Drolet, L. F. 1984. Pilot-plant studies of slow-rate filtration. *Journal AWWA*, Vol. 76. No. 12. pp. 62-68.
- Hendricks, D., J.M. Barrett, J. Bryck, M.R. Collins, B.A. Janonis, and G.S. Logsdon. 1991. *Manual of Design for Slow Sand Filtration*, Chapter 4: "Pilot Plant Studies," AWWA Research Foundation, Denver, CO.
- Recommended Standards for Water Works. 2012 Edition. Great Lakes – Upper Mississippi River Board of State and Provincial Public Health and Environmental Managers.
- Slezak, L. A., and R.C. Sims. 1984. The Application and Effectiveness of Slow Sand Filtration in the United States. *Journal AWWA*. Vol. 76, Issue 12, pp. 38-43.
- USEPA. 1999. *Microbial and Disinfection Byproduct Rules Simultaneous Compliance Manual*, EPA 815-R-99-015.

Wegelin, M. 1996. *Surface water treatment by roughing filters: a design, construction and operation manual*. SKAT (Swiss Centre for Development Cooperation in Technology and Management). St. Gallen, Switzerland.

Appendix I: Ultraviolet Disinfection

Executive Summary

This appendix identifies specific technical and regulatory issues associated with the approval and use of ultraviolet (UV) disinfection treatment for drinking water systems. It identifies the following conclusions and requirements:

- DOH will require that each typical reactor design undergo third party dosimetry-based validation testing before approving it for use in Washington state.
- 186 mJ/cm² is the minimum required applied dose for UV disinfection systems designed to provide 4-log inactivation of viruses.
- 40 mJ/cm² is the minimum required reduction equivalent dose where UV disinfection is used for compliance with the Surface Water Treatment Rule. This assumes virus inactivation is accomplished in conjunction with another disinfectant.
- Where UV is used to comply with the Long Term 2 Enhanced Surface Water Treatment Rule (LT2ESWTR), the validated dose will be as specified by the rule and the dosimetry-based validation testing for a proposed UV reactor.
- The quality of the raw water can greatly affect inactivation of target microorganisms with UV, and must meet specific criteria.
- Acceptable operations and maintenance procedures should be established during the design stage of UV disinfection system approval. UV reactors are complex systems and are not suitable for water systems without appropriately certified operators.
- UV reactors are validated using certain component parts. Changes in UV reactor components may decrease the effectiveness of the reactor to inactivate pathogens. As a result, disinfection credit awarded to a UV reactor is limited to the parts used in the original validation. Any modification to the UV reactor, such as replacing lamps, sleeves, ballasts, sensors, UV transmittance monitors, or controls, with parts other than those originally specified, may result in loss of UV disinfection credit.

Background and Purpose

There has been increasing interest in the potential use of UV light for disinfection purposes. There are several reasons for the interest, including a desire to avoid or eliminate using chlorine as a disinfectant, concern over formation of disinfection byproducts associated with chlorine, and a perceived simplicity of UV system operation. Of even greater interest is that UV light is extremely effective against the protozoan pathogens *Giardia lamblia* and *Cryptosporidium*.

The purposes of this document are to outline the technical issues involved with using UV light and to identify those considerations DOH will evaluate when reviewing specific UV disinfection system proposals.

Identifying Technical Issues

This document identifies several technical issues that are important to the use of UV light as an appropriate disinfection technique. It identifies multiple scenarios where water systems may apply UV. These are:

- Groundwater sources that DOH has determined do not require disinfection (WAC 246-290-250(4)).
- Groundwater sources that do require disinfection (WAC 246-290-451).
- Surface water sources that install UV disinfection to comply with the LT2ESWTR.
- Surface water sources that meet the limited alternative to filtration criteria.
- Other surface water sources where UV is used for compliance with the Surface Water Treatment Rule.

Different technical approaches and design criteria are used in addressing these scenarios. The technical issues are presented in five categories: reactor validation, public health criteria, water quality, design, and operations. We discuss these categories below. Much of the information presented in these documents is also in the Ultraviolet Disinfection Guidance Manual for the Final Long Term 2 Enhanced Surface Water Treatment Rule (UVDGM) (USEPA 2006).

Reactor Validation

UV disinfection is a technically complex process and there are few water systems in the United States that have installed UV disinfection for pathogen inactivation credit. The two predominant factors that affect the performance of a UV disinfection system are the irradiance distribution in the reactor, and the hydraulic flow characteristics of the reactor. In combination, these provide a fluence, or dose distribution that is unique to the water quality treated, and the specific operating conditions (for example, flow rate, lamp age, cleanliness of quartz sleeves).

In contrast to chlorine disinfection, where the disinfectant concentration is relatively consistent and easily measured, the approximate UV analogue, irradiance, varies significantly throughout the reactor, and can only be measured in those specific locations where a calibrated sensor is fixed. In chlorine disinfection systems, reactor hydraulic residence times are relatively long, and can be characterized through field-testing with physical measurements (for example, tracer studies).

The hydraulic residence time through UV reactors is on the order of a few seconds, and cannot be readily field-determined. These complications render it impractical for a design engineer or water system operator to determine the *true* fluence distribution for any given UV reactor under normal operating conditions. At best, some manufacturers may use sophisticated computational models to estimate the fluence distribution in their reactors. Design engineers and operating water systems must be sure that UV systems have been validated as effective under known operating and water quality conditions, and actual installations must be operated within specified parameters consistent with the validation. Therefore, DOH will require each reactor design to undergo dosimeter-based validation testing before approving it for use in Washington state.

UV reactors **must** be validated to establish the range of operating conditions that qualify for pathogen inactivation credit. Detailed, defined testing protocols have been developed in Germany (DVGW 2006) and Austria (ÖNORM 2001; ÖNORM 2003). Reactors certified at an approved DVGW [*Deutsche Vereinigung des Gas und Wasserfaches* (German Organization of Gas and Waterworks)] testing facility using the DVGW W294 protocol or ÖNORM [*Österreichisches Normungsinstitut* (Austrian Standards Institute)] facility using the ÖNORM M5873-1 or ÖNORM M5873-2 protocol will be considered as providing a reduction equivalent dose of 40 mJ/cm² within the validated conditions. For other validation efforts, Chapter 5 of the final UV Disinfection Guidance Manual (UVDGM - USEPA 2006) will be used to review proposed validation protocols. A full-scale reactor is necessary for all validation testing.

There are two different UV dose-monitoring strategies commonly used to control UV reactors and confirm that the reactor is providing the required dose within the validated range of operations. The sensor set point approach is one UV dose monitoring strategy. The other strategy is called the calculated dose approach. The DVGW W 294 and ÖNORM M5873 protocols use the sensor set point approach. Guidelines for the calculated dose approach are outlined in the UVDGM (USEPA 2006). The dose-monitoring strategy affects how a reactor validation is conducted as well as how the reactor is monitored after it is installed.

The UV equipment manufacturer is responsible for submitting complete validation information to DOH for review and approval. This responsibility includes submitting the details of the testing protocol to DOH before starting the testing. This validation will require verification of the conditions under which at least the minimum validated dose is provided. A third party acceptable to DOH must conduct the validation, not the manufacturer or water system.

Public Health Criteria

Disinfection requirements for ground and surface water systems are addressed in chapter 246-290 WAC. These are discussed in turn below.

Groundwater Sources Requiring Disinfection

WAC 246-290-250 (4) requires groundwater sources to be continuously disinfected unless acceptable source water quality (for example, historical absence of coliform organisms) and an acceptable sanitary control area are provided. This general requirement is consistent with the more specific requirements in WAC 246-290-451, which lists conditions under which disinfection of a groundwater supply is required; and in WAC 246-290-453, which requires 4-log inactivation of viruses in groundwater supplies under certain specified conditions, including the detection of *E. coli* in a triggered source sample.

When a groundwater source is contaminated, or threatened with contamination, the source is subject to a multiplicative combination of chlorine residual (C) and contact time (T) that results in a product (termed CT) of at least 6 mg/L-min. The *Surface Water Treatment Rule Guidance Manual* (USEPA 1990) identifies this with free chlorine used as the required level to provide 4-log inactivation of viruses in water at 10°C, pH 6-9. If temperature and/or pH are outside the values necessary to provide 4-log virus inactivation at CT6, DOH may require a higher CT value. The values in EPA's guidance manual are based on hepatitis A virus inactivation data and an applied safety factor of 3. The Ground Water Rule source disinfection treatment requirements in WAC 246-290-453 requires 4-log inactivation of viruses in groundwater supplies under certain specified conditions, including the detection of *E. coli* in a triggered source sample. WAC 246-290-453 also imposes a higher standard for monitoring, reporting, and public notification in the event of a treatment technique violation.

In January 2006, EPA finalized LT2ESWTR. While the focus of the LT2ESWTR is on surface water sources, the rule also established UV dose requirements for viruses. In November 2006, EPA finalized the Ground Water Rule. Treatment equipment installed to comply with this rule **must** provide 4-log inactivation or removal of viruses (WAC 246-290-453(1)). For UV disinfection, that means the minimum required validated dose is 186 mJ/cm². The reduction equivalent dose for a given UV reactor will likely be greater because of the uncertainties inherent in the validation of UV reactors.

Groundwater Sources Not Required to Disinfect

We recommend that installations provide a UV dose of at least 186 mJ/cm² and that water systems meet the same design criteria applied to sources required to disinfect. Water systems that install UV treatment units that have not been validated will be

required to install validated equipment (or use another DOH-approved disinfectant) if disinfection is required in the future, and may be required to conduct additional source water sampling for coliform bacteria as required by the Ground Water Rule.

Surface Water

Surface water treatment regulations prescribe treatment techniques that, either in combination with filtration or alone, achieve identified levels of inactivation and/or removal of pathogens. All surface water systems **must** provide a minimum of 3-log removal and/or inactivation of *Giardia lamblia* and 4-log inactivation and/or removal of viruses, and control of pathogenic bacteria. These requirements are prescribed in the federal Surface Water Treatment Rule (40 CFR 141.70 through 141.75), and chapter 246-290 WAC, Part 6. The Interim Enhanced Surface Water Treatment Rule (IESWTR) and Long Term 1 Enhanced Surface Water Treatment Rule (LT1ESWTR) impose a 2-log *Cryptosporidium* removal requirement on water systems required to filter. With the promulgation of LT2ESWTR, EPA formally recognized the effectiveness of UV for inactivation of *Giardia lamblia* and *Cryptosporidium*. The LT2ESWTR public health protection requirements are **in addition to** those required by the Surface Water Treatment Rule, IESWTR, and the LT1ESWTR. We explain the different UV disinfection standards for disinfection of surface water sources in more detail below.

Limited Alternative to Filtration

To meet the limited alternative to filtration (LAF) standards, the water system **must** provide **greater** removal or inactivation of pathogens for the surface water source than the combination of chlorination and filtration would provide (WAC 246-290-630(11)). Where UV disinfection is used to meet LAF requirements, DOH requires that a minimum design dose of 40 mJ/cm² be used.

Long Term 2 Enhanced Surface Water Treatment Rule

The LT2ESWTR was developed to provide additional public health protection from pathogens present in surface water, especially *Cryptosporidium*. The rule requires **additional** treatment for some sources based on their source water *Cryptosporidium* concentrations and treatment currently provided. UV disinfection is one option that water systems have to comply with the additional treatment requirements.

UV light inactivates *Cryptosporidium* at relatively low doses compared to several other surface water pathogens. Therefore, the doses required are expected to be less than 40 mJ/cm² in most cases. The LT2ESWTR and associated UVDGM identify the installation design and operation requirements for UV disinfection. DOH expects the design engineer installing UV disinfection to consult the LT2ESWTR and UVDGM as part of the design process to ensure compliance.

Surface Water Treatment Rule

When the Surface Water Treatment Rule was finalized, it focused on the use of chemical disinfectants to inactivate waterborne pathogens. At the time, the most disinfection resistant pathogen regulated was *Giardia lamblia*. In 2001, DOH recognized research that indicated UV could effectively inactivate *Giardia lamblia* at relatively low doses. We established a minimum UV dose of 40 mJ/cm² when water systems use disinfection to comply with the Surface Water Treatment Rule. This is the same UV dose required by the widely accepted German and Austrian standards, which considered the sensitivity of several pathogens along with their ability for enzymatic repair of their damaged nucleic acids in establishing a minimum required UV dose. This minimum reduction equivalent dose is more than sufficient to provide 1-log credit for inactivation of *Giardia lamblia*.

Surface water sources **must** also provide 4-log inactivation or removal of viruses. Because viruses are more readily inactivated by chemical disinfectants than *Giardia lamblia*, water systems that provided at least 0.5-log inactivation of *Giardia lamblia* with a chemical disinfectant readily met the 4-log virus inactivation requirement. There are some viruses, especially adenoviruses, which are more UV resistant than *Giardia lamblia*. Adenoviruses were not used to establish the German UV disinfection standard of 40 mJ/cm². However, the LT2ESWTR used adenoviruses to establish the UV dose tables for viruses in the rule. Based on this information, reduction equivalent doses greater than 40 mJ/cm² will be required for virus inactivation credit.

Disinfection **must** be continuously provided for surface water sources (WAC 246-290-662(1)). In this case, "continuous" means a period of 15 or more minutes. If a water system fails to provide the required UV dose for 15 or more minutes, they must contact DOH. Failure to provide the required UV dose on a surface water source more than one day per month is considered a treatment technique violation (WAC 246-290-662(4)(b)).

Water Quality

Water quality can significantly influence the effectiveness of UV disinfection. Reductions in effectiveness can result from direct absorbance of UV radiation by the water and various constituents in the water, by the shielding of organisms often associated with higher turbidities, and by scales forming (fouling) on lamp sleeves. The following list identifies several water quality parameters to consider.

- **Iron and Manganese:** Ferric iron strongly absorbs UV radiation. It can negatively affect a reactor's ability to inactivate microorganisms by "consuming" the UV before microorganisms absorb it. Iron and manganese oxides can cause scaling on the quartz sleeve that would reduce the UV irradiance that enters the water column. Iron and manganese concentrations as low as 0.1 mg/L and 0.02 mg/L can cause significant fouling of quartz sleeves (Mackey et al. 2001; Chen 2009;

Black and Hill 2009). The water system should remove iron or manganese exceeding the secondary contaminant levels of 0.3 mg/L, or 0.05 mg/L, respectively, prior to UV application.

- **Hardness:** Hardness greater than 140 mg/L as CaCO₃ can cause scaling on the quartz sleeve that would reduce the UV irradiance that enters the water column (Mackey et al. 2001; Black and Hill 2009). Solubility calculations for carbonates of calcium and magnesium can provide a preliminary screening of the likelihood of precipitation. If it appears possible, then the water system should perform pilot testing using the same lamp proposed for the full-scale application.
- **Total Organic Carbon:** Many naturally occurring organic materials in water strongly absorb UV radiation. Like iron, they can negatively affect a reactor's ability to inactivate microorganisms. The nature and amount of the specific organic carbon in the water strongly affects UV disinfection effectiveness. This should become evident through UV transmittance measurements.
- **Turbidity:** Turbidity is a measure of a solution's ability to scatter light as a result of particulate matter. Turbidity alone cannot be directly correlated to a predictable effect on UV system effectiveness; and, in some cases, turbidity in excess of 5 NTU has not resulted in diminished UV inactivation performance (Passatino and Malley 2001). However, water systems are required to provide turbidity control to less than 5 NTU. In groundwater, turbidity is often a result of iron or manganese precipitation, and removing these inorganics may eliminate the turbidity problem.
- **UV Transmittance** (of the water): UV transmittance is a measure of water's ability to transmit ultraviolet radiation, and is a function of the factors identified above, as well as some water treatment chemicals (Cushing et al. 2001). The UV transmittance of raw water directly affects the ability of UV light to disinfect raw water adequately. Design engineers should perform validation testing consistent with the UV transmittance of the water for which they propose treatment.

Most water systems do not have historical records of many of the above parameters. **A water system considering UV should begin sampling on at least a monthly basis for each of the above.** More frequent testing may be required if significant variation in water quality is expected. It may not be possible to predict the fouling characteristics of any particular water, and pilot testing may be appropriate in some cases. While piloting will likely not be required, opting out of piloting may increase the risk that the facility will not operate as expected.

Design

It is important to consider a range of issues in the design of a UV disinfection system, including:

- Inlet and outlet conditions: Correlate to match the validation conditions (or be hydraulically more conservative).
- Reactor isolation: Drip-tight reactor isolation valves. If reactors are flooded with chemicals for cleaning, provide additional isolation such as double block-and-bleed valve arrangements.
- UV system operation consistent with the identified flow rate (positive flow control may be required).
- Accommodate the "start-stop" operation typical of many small and medium treatment systems to account for warm-up and cool-down requirements of some UV systems (You may need a "flow-to-waste" cycle).
- The possibility and control of hydraulic shock, or potential for significant hydraulic transients.
- The need for reliability and redundancy of a treatment system (may require parallel units).
- Recognition that power fluctuations can shut down some UV systems (while not having the same effect on pumps), and the need for alarm and automatic shut-off features to prevent untreated water from entering the distribution system (an uninterruptible power supply may be applicable).
- Because UV lamps contain mercury, a complete assessment of a particular treatment system's vulnerability to lamp breakage and mercury release (included in an emergency response plan).
- The need for a reliable, stable, calibrated UV irradiance sensor system installed and monitored for operational control. The sensor system, which may be one or several individual sensors, is integrally included in the validation process, and should be well described in both the validation test report and the specific design report for the project.

You can find additional initial design considerations that you will evaluate during the review of any specific proposal in the UVDGM (USEPA 2006).

UV Disinfection Design Checklist

In addition to the guidance for preparing UV disinfection submittals in this appendix, we recommend the *Ultraviolet Disinfection Guidance Manual for the Final Long Term 2 Enhanced Surface Water Treatment Rule* (USEPA 2006), and AWWA Standard F110 (AWWA

2016). Consult these resources in addition to the items below when preparing project reports and construction documents for UV disinfection facilities.

Project Reports for UV installation projects should include the following at a minimum:

- **Reactor validation report** submitted to and approved by DOH. The reactor validation must identify the operating conditions the minimum UV dose will address (flow, UV intensity, and UV lamp status).
- **Describe CT requirements** and the design factor of safety.
- **Water quality data** over a sufficient duration to characterize the source water adequately, usually monthly for a year, unless DOH agrees otherwise. Key water quality parameters include:
 - UV transmittance (daily)
 - Turbidity (daily)
 - Iron and manganese (Iron at least weekly to capture transient events)
 - Hardness
 - Total organic carbon
- **UV reactor dose-response monitoring strategy.** If the calculated dose approach is used, the reactor validation must include measurements of UV transmittance and an empirical dose-monitoring equation developed through the validation testing.
- **A description of the hydraulics** including inlet and outlet conditions to be similar to or more conservative than the ones used in the reactor validation.
- **Provisions for reactor isolation** including adequate valves to prevent short-circuiting and allow for maintenance.
- **Provisions for redundancy** including providing more than one UV reactor to allow for chemical cleaning and equipment maintenance. A redundant reactor may be needed to ensure that design flows can be met.
- **Power quality analysis** including analysis of sub-second power interruptions and voltage sags for the location of a proposed UV facility. Inclusion of an uninterruptible power supply or power conditioning equipment as appropriate.
- **Lamp-breakage response plan** that defines emergency response actions the water system will take; include notifying DOH if a lamp breaks. You should evaluate the potential for hydraulic transients because they may cause the quartz sleeves that house UV lamps to fail.
- **Monthly operating and monitoring report form** acceptable to DOH. The report form must identify the conditions for which the minimum required UV dose can be provided. Sensor checks and UV transmittance monitor checks, as appropriate, may be included on the form or as part of a separate report.

- **Describe start/stop operational operations** including flow-to-waste, flow recirculation, and other ways to minimize the amount of inadequately disinfected water entering the distribution system during reactor start-up.
- **Describe design assumptions, instrumentation, and data used** to continuously monitor and calculate UV efficacy (flow, UV intensity, and UV absorbance) and clearly identify alarms and shutdown conditions. See [Policy F.13](#).
- **Operations and maintenance plan**, including
 - Testing and calibrating sensors, meters, and alarms.
 - Cleaning procedure.
 - Lamp replacement procedure.
 - Training for every operator with UV reactor operational or maintenance responsibility.
 - Confirmation the certified operator reviewed and had the opportunity for input on the design and O&M plan.
- **New UV reactor commissioning process:**
 - The manufacturer's written certification showing the UV system is installed correctly prior to starting up the UV system.
 - Verify that upstream piping is free of rocks or debris that could damage sleeves and lamps.
 - Prepare lamp-break response procedure. Include mercury release response and cleanup procedure.
 - Review UV system O&M Manual Standard Operating Protocol prior to startup.
 - Calibrate instruments, sensors, and meters supplied as part of the UV system that you will use during testing, including UVT analyzers, UV intensity sensors, and power consumption meters.
 - Conduct dry testing first, with a follow-up period of wet testing. The UV supplier has a duty to identify tests that require testing with a dry reactor and those that require wet testing. Include ancillary equipment, such as flow meters and modulating valves.
 - Test the UV system under all design conditions. Verify that the UV reactor is adjusting power to maintain target disinfection levels at varying flows and UVTs. Verify that the system records and displays correct information for continuous monitoring and monthly reporting. Verify all alarm set points. Verify that the values reported on the UV control panel(s) match the values displayed and recorded in the SCADA system.
 - Test the UV system under a power failure scenario to demonstrate proper shutdown or flow diversion response.

- Verify correct operation of sleeve cleaning system, if included.
- Run the UV system for several days to verify proper performance under normal operation.
- Issue written acceptance.
- Complete applicable portions of monthly operational reports and submit to DOH.

Credit: Kim Ervin, PE, Jacobs Engineering

Operations

As with all treatment systems, UV disinfection equipment requires regular monitoring and maintenance. We developed report forms for UV disinfection reporting that water systems may use for operational records. If we grant disinfection credit, a water system **must** submit a report to us on a monthly basis (WAC 246-290-480, 666, and 696). The following table shows the minimum monitoring and reporting requirements. Individual projects may require variations on ways water systems present these data; however, the elements in the table are basic.

UV Disinfection Monitoring/Reporting Elements

Parameter	Monitoring Frequency	Reporting Requirement
Flow	Continuous	Peak Daily
Irradiance	Continuous	Minimum Daily Value (Amount of time below minimum allowable levels if using sensor set point control)
Dose	Continuous (Applies only for calculated dose control)	Minimum Daily Value if using calculated dose control. (Amount of time below minimum required dose)
UV Transmittance (UVT)	Continuous (Continuous UVT monitoring required only for calculated dose control. A daily grab sample should be taken when using sensor set point control.)	Minimum Daily Value. UVT during minimum calculated dose. Weekly comparison to bench-top reading. Date of most recent calibration
Power	Continuous	Daily Lamp Status
Lamp Operating Time	Continuous	Cumulative operation hours (note when lamp is changed)
Alarms	Continuous	Note high priority alarm conditions occurring during the month
Cumulative Number of Off/On Cycles	Continuous	Monthly total

Parameter	Monitoring Frequency	Reporting Requirement
Sensor Status	N/A	Monthly comparison of working and reference sensors. Note when factory calibrated system sensor (min. annually)

References

- AWWA. 2016. *F110 - AWWA Standard for Ultraviolet Disinfection Systems for Drinking Water*. American Water Works Association, Denver, CO.
- Black, B. 2009. "UV Disinfection Fouling and Cleaning". Proceedings PNWS-AWWA Workshop Destination "UV"ination, Portland, Oregon, Feb. 25-26.
- Chen, A. 2009. "180 MGD UV Disinfection – O&M Lessons Learned". Proceedings PNWS-AWWA Workshop Destination "UV"ination, Portland, Oregon, Feb. 25-26.
- DVGW. 2006. *UV Disinfection Devices for Drinking Water Supply - Requirements and Testing*, DVGW W294, Deutsche Vereinigung des Gas und Wasserfaches, Bonn, Germany.
- ÖNORM. 2001. *Plants for the Disinfection of Water Using Ultraviolet Radiation - Requirements and Testing - Part 1: Low Pressure Mercury Lamp Plants*, ÖNORM M 5873-1, Osterreiches Normungsinstitut, Vienna, Austria.
- ÖNORM. 2003. *Plants for the Disinfection of Water Using Ultraviolet Radiation - Requirements and Testing - Part 2: Medium Pressure Mercury Lamp Plants*, ÖNORM M 5873-2, Osterreiches Normungsinstitut, Vienna, Austria.
- Mackey, E. 2001. R.S. Cushing, and H. B Wright. 2001. Effect of water quality on UV disinfection of drinking water. Proceedings of the First International Ultraviolet Association Congress, Washington, D.C. June 14-16.
- Passatino, L. and J. P. Malley. 2001. "Impacts of Turbidity and Algal Content of Unfiltered Drinking Water Supplies on the Ultraviolet Disinfection Process," Proceedings AWWA Annual Conference and Exposition, Washington D.C.
- USEPA. 1990. *Guidance Manual for Compliance with the Filtration and Disinfection Requirements for Public Water Systems Using Surface Water Sources*, EPA Contract No. 68-01-6989.
- USEPA. 2006. *Ultraviolet Disinfection Guidance Manual for the Final Long Term 2 Enhanced Surface Water Treatment Rule*