

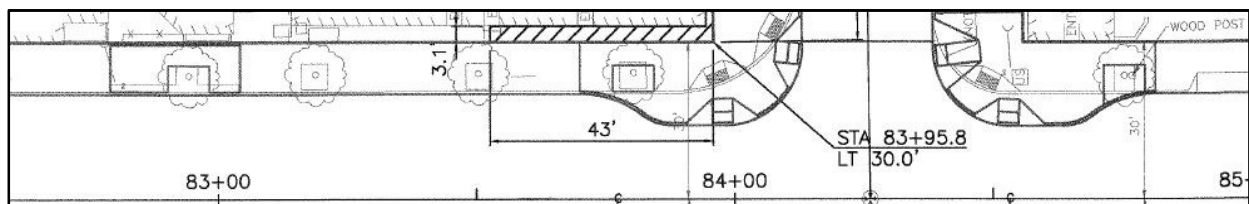

Seattle Department of Transportation

The Americans with Disabilities Act (ADA) Transition Plan for the Seattle Public Right-of-Way

Appendix 4.2a: 2017 Seattle Municipal Curb Ramp Standards



400 STREET PAVING & APPURTENANCES

STANDARD PLAN NO **422a**

REV DATE: JAN 2017

NOTES:

1. RAMP CENTERLINE SHALL BE RADIAL/PERPENDICULAR TO THE ALIGNMENT OF THE FACE OF CURB.
2. UPPER LANDING AT THE TOP OF THE CURB RAMP SHALL MATCH THE FULL WIDTH OF THE RAMP AND SHALL HAVE A MINIMUM DEPTH OF 4'-0". IF THE LANDING IS LIMITED AT THE BACK-OF-SIDEWALK BY A PERMANENT VERTICAL BARRIER, THE DEPTH OF THE TURNING SPACE SHALL BE 5'-0" MINIMUM, MEASURED PARALLEL TO THE RUN OF THE CURB RAMP. SLOPE ON THE LANDING SHALL BE BETWEEN 0.5% AND 2% IN ANY DIRECTION.
3. WINGS SHALL HAVE A MAXIMUM SLOPE OF 10%. WINGS SHALL HAVE A BRUSHED FINISH PARALLEL TO THE CURB. THE CONCRETE WALK THICKENED EDGE ALONG THE CURB SHALL CONTINUE THROUGH EACH WING.
4. RAMP SURFACE SHALL HAVE A HEAVY BROOM BRUSHED SURFACE PARALLEL TO THE CURB.
5. REFER TO DETAILS 422K AND 422L FOR GENERAL NOTES AND TYPICAL SECTIONS.

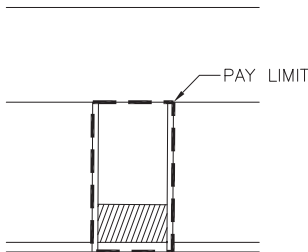
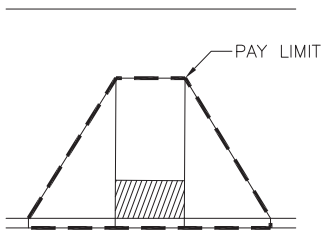
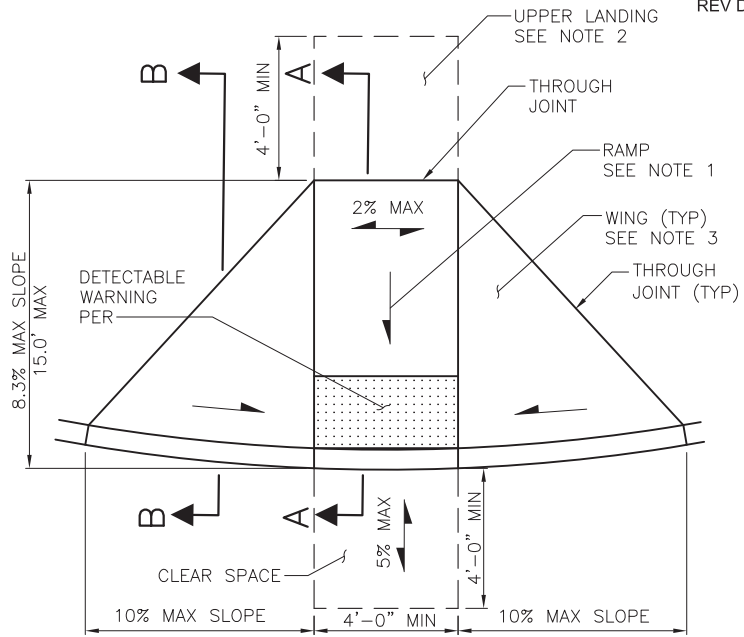

PAY LIMITS

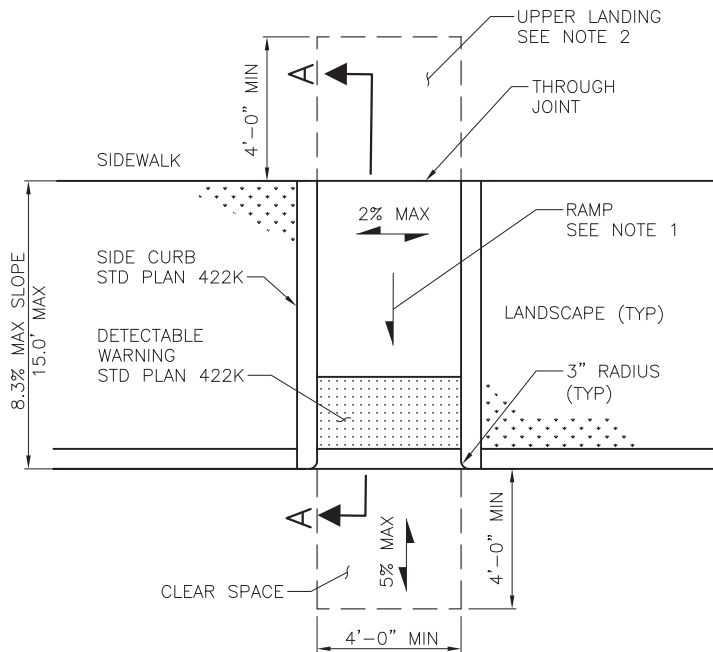

PERPENDICULAR CURB RAMPS

(TYPE 422A)

2% MAX = MAX SLOPE IN EITHER DIRECTION

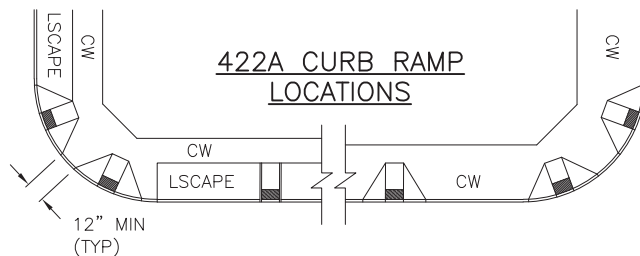

REF STD SPEC SEC 8-14



City of Seattle

NOT TO SCALE

CURB RAMP DETAILS

NOTES:

1. RAMP CENTERLINE(S) SHALL BE PARALLEL TO THE ALIGNMENT OF THE FACE OF CURB. THE WIDTH OF THE RAMP SHALL BE 5'-0" MINIMUM BUT 6'-0" IS PREFERRED.
2. SHARED LOWER CURB RAMP LANDING SHALL HAVE A MINIMUM WIDTH OF 5'-0". SLOPE OF THE LANDING SHALL BE BETWEEN 0.5% AND 2% IN ANY DIRECTION.
3. RAMP SURFACE SHALL HAVE A HEAVY BROOM BRUSHED SURFACE RADIAL/PERPENDICULAR TO THE CURB.
4. REFER TO DETAILS 422K AND 422L FOR GENERAL NOTES AND TYPICAL SECTIONS.

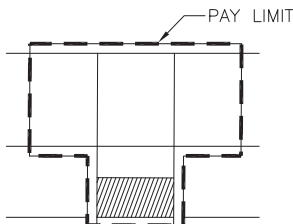
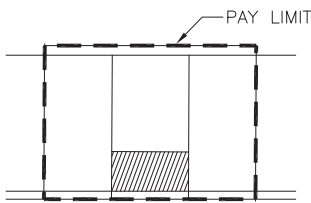
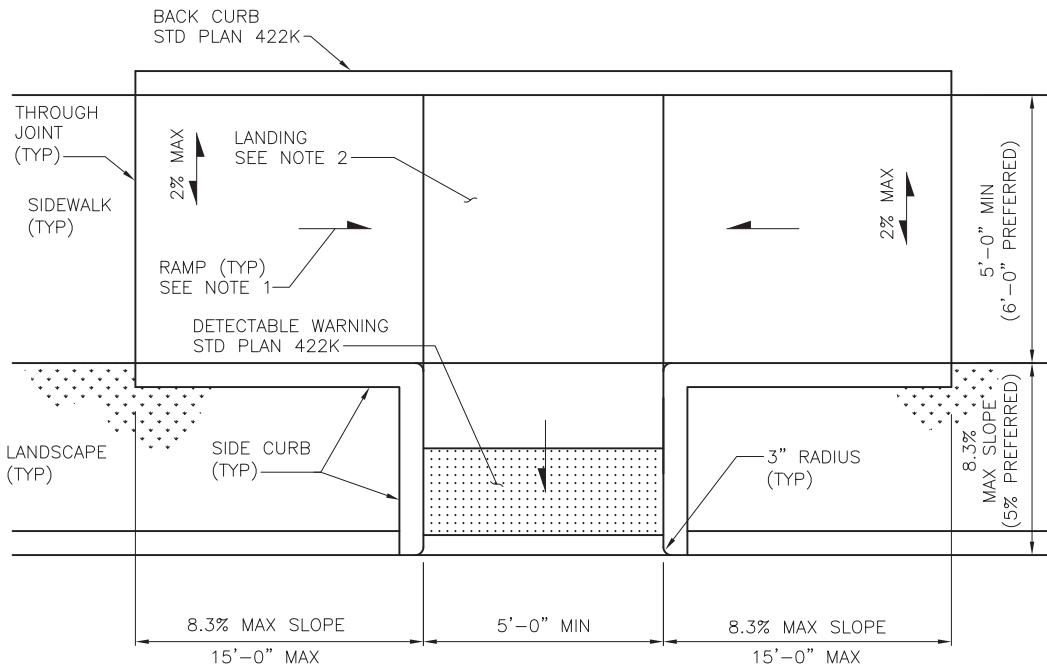
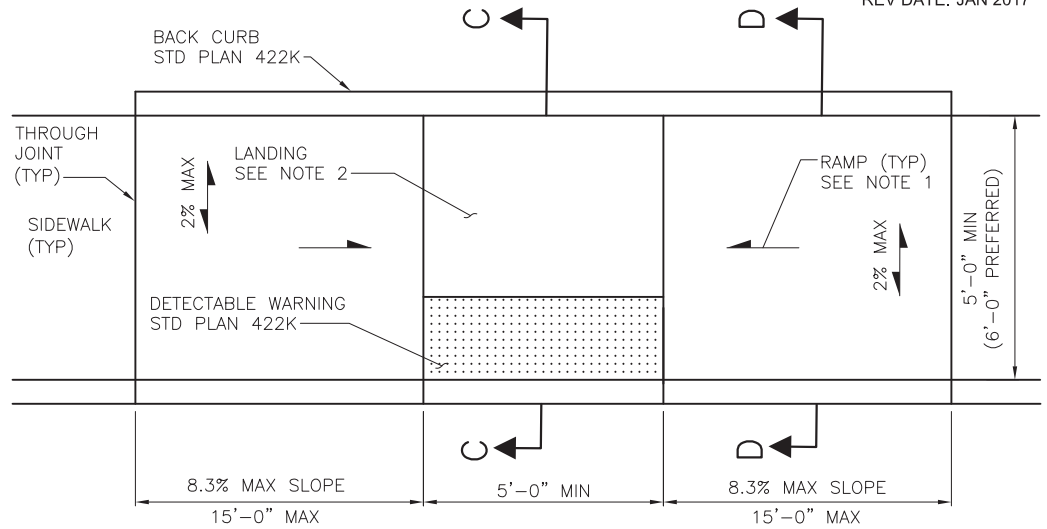

PAY LIMITS

2% MAX
 ↔ = MAX SLOPE IN EITHER DIRECTION

PARALLEL CURB RAMPS
 (TYPE 422B)

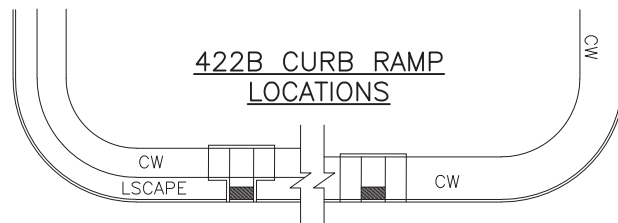

REF STD SPEC SEC 8-14



City of Seattle

NOT TO SCALE

CURB RAMP DETAILS

NOTES:

1. RAMP CENTERLINE(S) SHALL BE PARALLEL TO THE ALIGNMENT OF THE FACE OF CURB. THE WIDTH OF THE RAMP SHALL BE 5'-0" MINIMUM BUT 6'-0" IS PREFERRED.
2. SHARED LOWER CURB RAMP LANDING SHALL HAVE A MINIMUM WIDTH OF 5'-0". SLOPE OF THE LANDING SHALL BE BETWEEN 0.5% AND 2% IN ANY DIRECTION.
3. RAMP SURFACE SHALL HAVE A HEAVY BROOM BRUSHED SURFACE RADIAL/PERPENDICULAR TO THE CURB. REFER TO DETAILS 422K AND 422L FOR GENERAL NOTES AND TYPICAL SECTIONS.

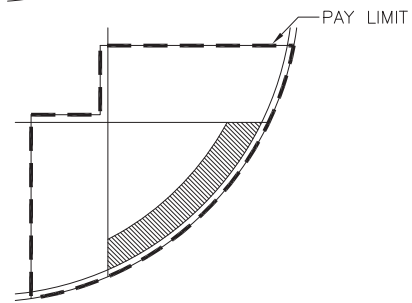
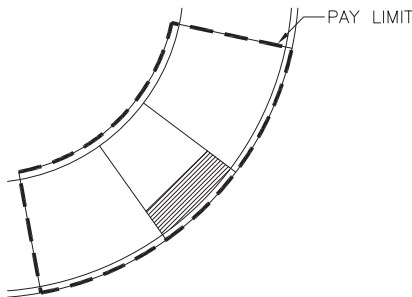
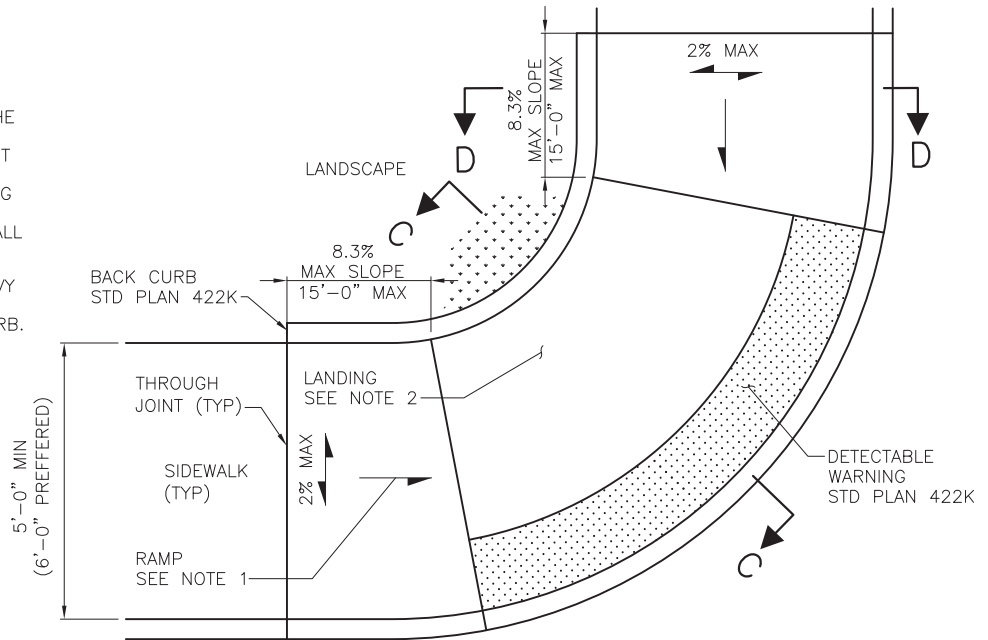

PAY LIMITS

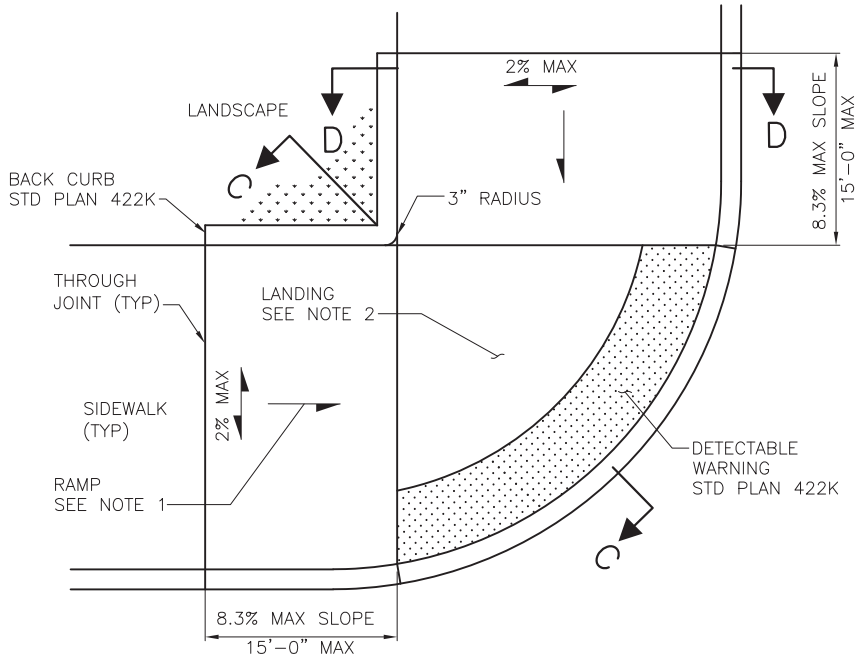

PARALLEL CURB RAMPS (CORNER)
(TYPE 422C)

2% MAX
 = MAX SLOPE IN EITHER DIRECTION

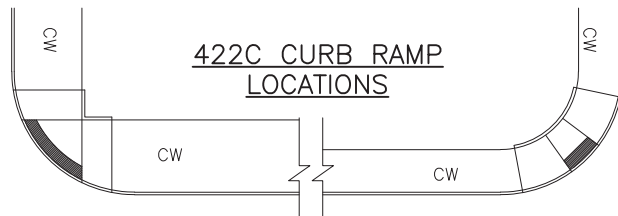

422C CURB RAMP LOCATIONS

REF STD SPEC SEC 8-14



City of Seattle

NOT TO SCALE

CURB RAMP DETAILS

NOTES:

1. RAMP CENTERLINE SHALL BE PARALLEL TO CROSSWALK AND/OR THE SIDEWALK.
2. UPPER LANDING AT THE TOP OF THE CURB RAMP SHALL MATCH THE FULL WIDTH OF THE RAMP AND SHALL HAVE A MINIMUM DEPTH OF 4'-0". IF THE LANDING IS LIMITED AT THE BACK-OF-SIDEWALK BY A PERMANENT VERTICAL BARRIER, THE DEPTH OF THE TURNING SPACE SHALL BE 5'-0" MINIMUM, MEASURED PARALLEL TO THE RUN OF THE CURB RAMP. SLOPE ON THE LANDING SHALL BE BETWEEN 0.5% AND 2% IN ANY DIRECTION.
3. WINGS SHALL HAVE A MAXIMUM SLOPE OF 10%. WINGS SHALL HAVE A BRUSHED FINISH PARALLEL TO THE CURB. THE CONCRETE WALK THICKENED EDGE ALONG THE CURB SHALL CONTINUE THROUGH EACH WING.
4. WING ON THE OPEN SIDE OF THE CURB RAMP SHALL HAVE A MINIMUM SLOPE OF 5% TO ASSIST PEDESTRIANS WITH VISUAL IMPAIRMENTS WHERE THE DETECTABLE WARNING SURFACE IS OFFSET FROM THE CURB LINE.
5. RAMP SURFACE SHALL HAVE A HEAVY BROOM BRUSHED FINISH PERPENDICULAR TO THE PATH OF TRAVEL.
6. REFER TO DETAILS 422K AND 422L FOR GENERAL NOTES AND TYPICAL SECTIONS.

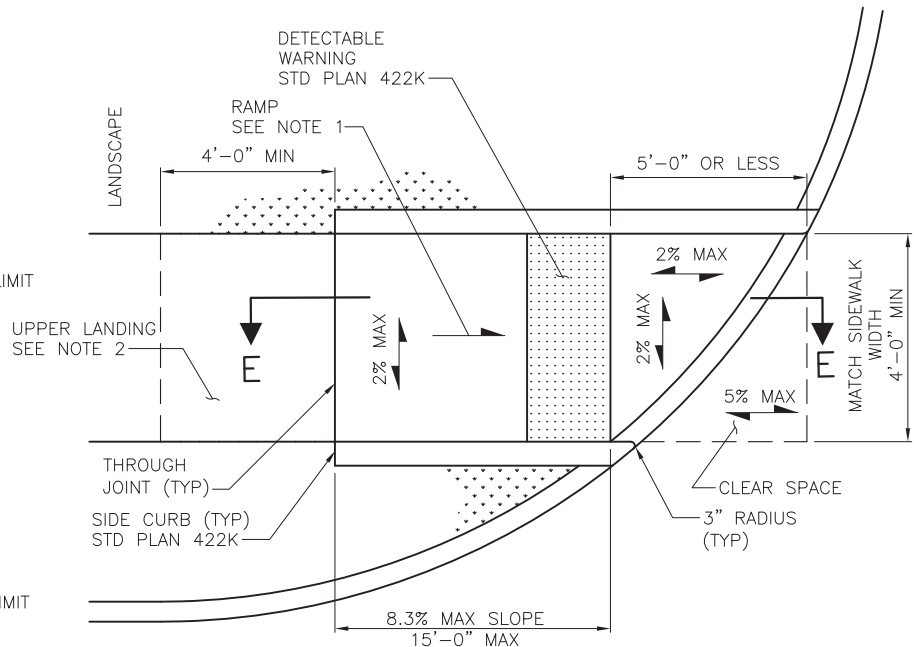
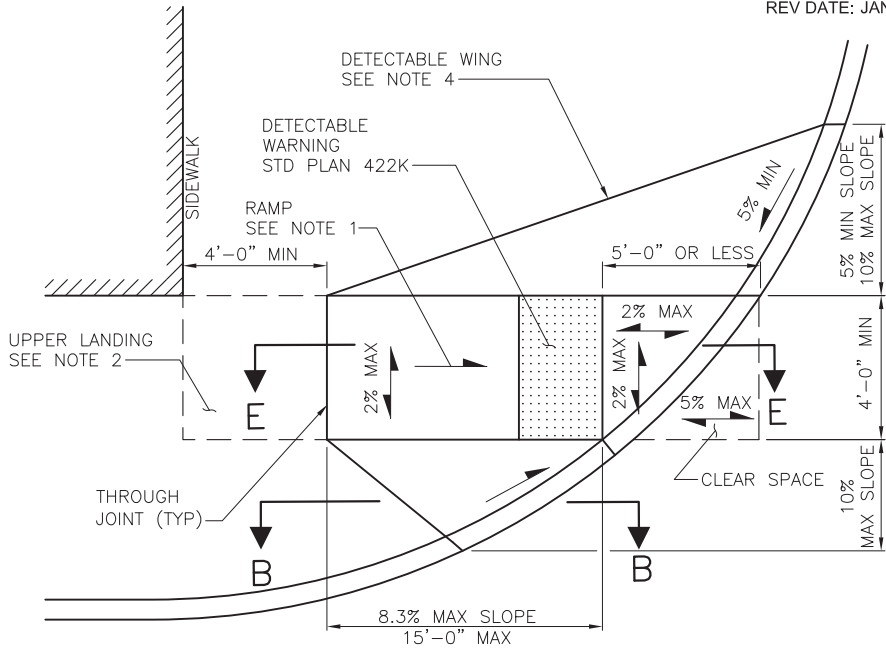

DIRECTIONAL CURB RAMPS
(TYPE 422D)

2% MAX
← = MAX SLOPE IN EITHER DIRECTION

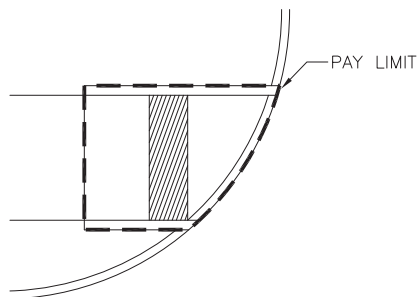
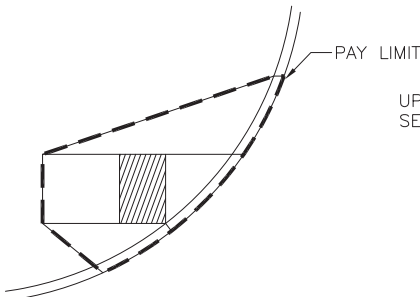

PAY LIMITS

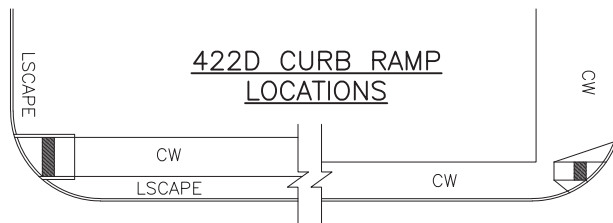

REF STD SPEC SEC 8-14



City of Seattle

NOT TO SCALE

CURB RAMP DETAILS

NOTES:

1. RAMP CENTERLINE SHALL BE PARALLEL TO CROSSWALK AND/OR THE SIDEWALK.
2. UPPER LANDING AT THE TOP OF THE CURB RAMP SHALL MATCH THE FULL WIDTH OF THE RAMP AND SHALL HAVE A MINIMUM DEPTH OF 4'-0". IF THE LANDING IS LIMITED AT THE BACK-OF-SIDEWALK BY A PERMANENT VERTICAL BARRIER, THE DEPTH OF THE TURNING SPACE SHALL BE 5'-0" MINIMUM, MEASURED PARALLEL TO THE RUN OF THE CURB RAMP. SLOPE ON THE LANDING SHALL BE BETWEEN 0.5% AND 2% IN ANY DIRECTION.
3. WINGS SHALL HAVE A MAXIMUM SLOPE OF 10%. WINGS SHALL HAVE A BRUSHED FINISH PARALLEL TO THE CURB. THE CONCRETE WALK THICKENED EDGE ALONG THE CURB SHALL CONTINUE THROUGH EACH WING.
4. WHERE THE SETBACK FROM THE BOTTOM OF THE CURB RAMP TO THE BACK OF CURB LINE EXCEEDS 5'-0", THE DETECTABLE WARNING SURFACE SHALL BE INSTALLED AT THE BACK OF CURB (NOT AT THE BOTTOM OF RAMP).
5. DIRECTIONAL CURB RAMP WITH LARGE SETBACK FROM BACK OF CURB TO BOTTOM OF THE CURB RAMP ARE NOT PREFERRED DESIGNS BUT MAY BE USED IF NECESSARY DUE TO EXISTING SITE CONSTRAINTS. THIS DESIGN WILL LIKELY REQUIRE THE CUTTING OR ALTERING A DETECTABLE WARNING SURFACE TO FIT.
6. STRAIGHT SECTIONS OF DETECTABLE WARNING SURFACE IS PERMITTED AS AN ALTERNATE. IF USED, THERE SHALL BE 2" MAXIMUM FROM THE DETECTABLE WARNING SURFACE TO THE BACK OF CURB AT ANY POINT.
7. RAMP SURFACE SHALL HAVE A HEAVY BROOM BRUSHED FINISH PERPENDICULAR TO THE PATH OF TRAVEL.
8. REFER TO DETAILS 422K AND 422L FOR GENERAL NOTES AND TYPICAL SECTIONS.

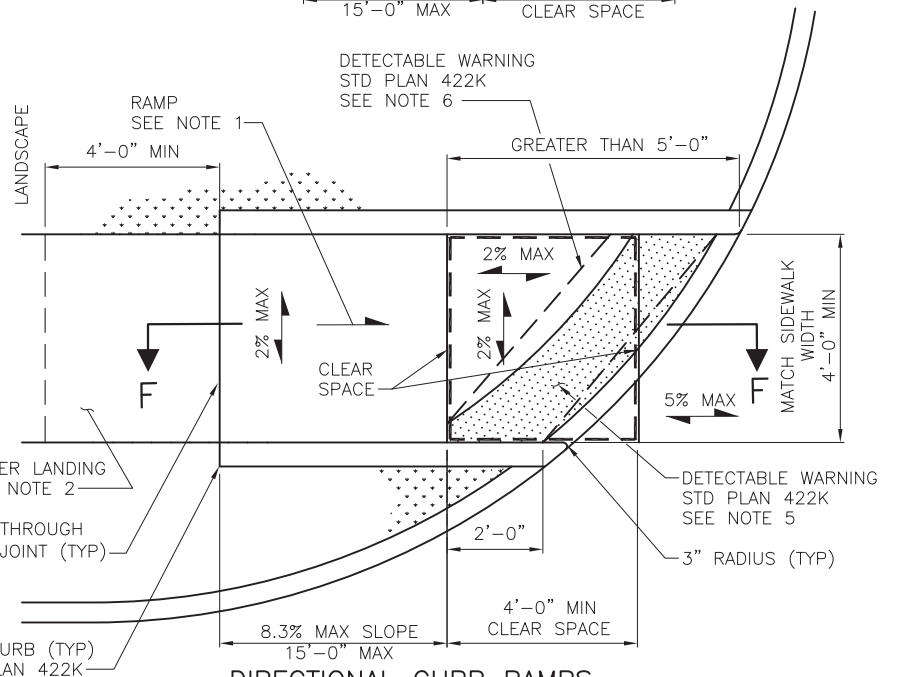
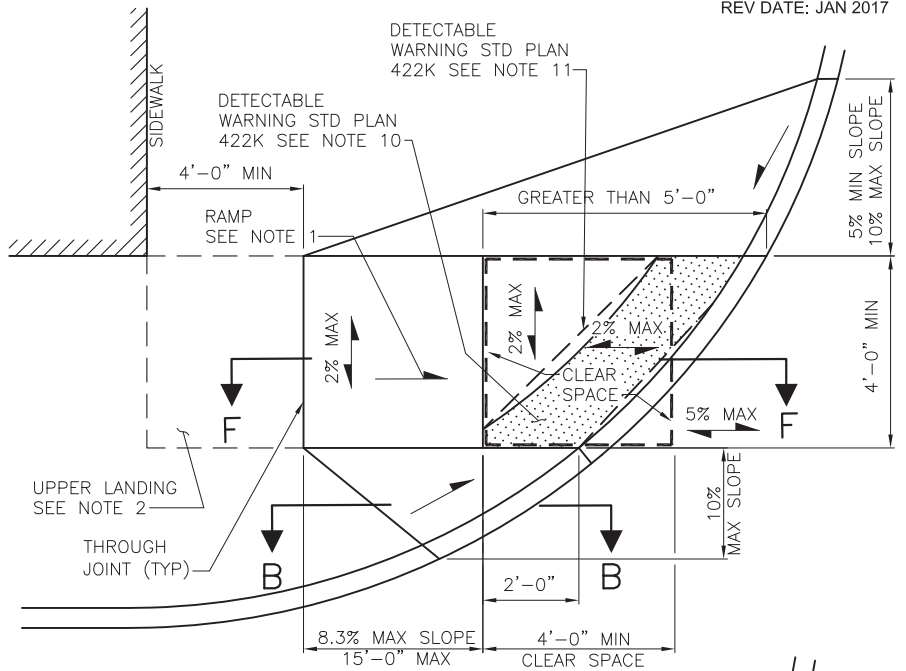

DIRECTIONAL CURB RAMP
(TYPE 422E)

2% MAX = MAX SLOPE IN EITHER DIRECTION

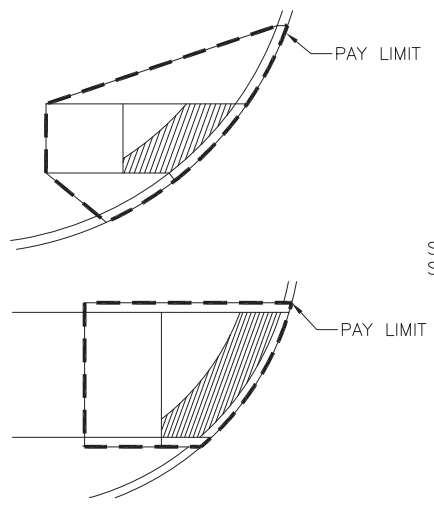

PAY LIMITS

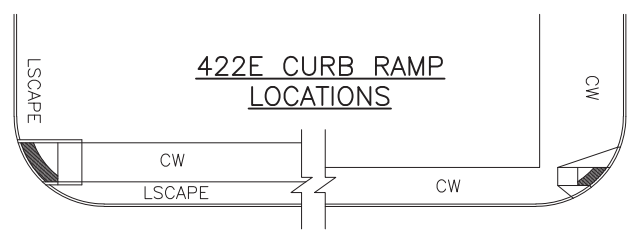

REF STD SPEC SEC 8-14



City of Seattle

NOT TO SCALE

CURB RAMP DETAILS

NOTES:

1. RAMP CENTERLINE(S) SHALL BE PARALLEL TO CROSSWALK AND/OR THE SIDEWALK.
2. UPPER LANDING AT THE TOP OF THE CURB RAMP SHALL MATCH THE FULL WIDTH OF THE RAMP AND SHALL HAVE A MINIMUM DEPTH OF 4'-0". IF THE LANDING IS LIMITED AT THE BACK-OF-SIDEWALK BY A PERMANENT VERTICAL BARRIER, THE DEPTH OF THE TURNING SPACE SHALL BE 5'-0" MINIMUM, MEASURED PARALLEL TO THE RUN OF THE CURB RAMP. SLOPE ON THE LANDING SHALL BE BETWEEN 0.5% AND 2% IN ANY DIRECTION.
3. WINGS SHALL HAVE A MAXIMUM SLOPE OF 10%. WINGS SHALL HAVE A BRUSHED FINISH PARALLEL TO THE CURB. THE CONCRETE WALK THICKENED EDGE ALONG THE CURB SHALL CONTINUE THROUGH EACH WING.
4. WING ON THE OPEN SIDE OF THE CURB RAMP SHALL HAVE A MINIMUM SLOPE OF 5% TO ASSIST PEDESTRIANS WITH VISUAL IMPAIRMENTS WHERE THE DETECTABLE WARNING SURFACE IS OFFSET FROM THE CURB LINE.
5. RAMP SURFACE SHALL HAVE A HEAVY BROOM BRUSHED FINISH PERPENDICULAR TO THE PATH OF TRAVEL.
6. REFER TO DETAILS 422K AND 422L FOR GENERAL NOTES AND TYPICAL SECTIONS

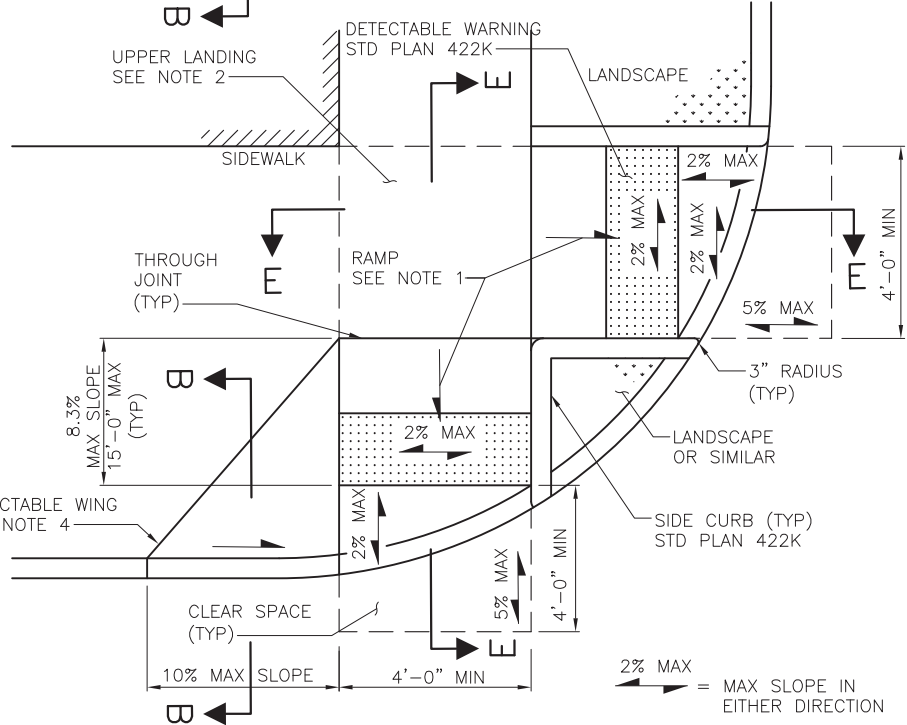
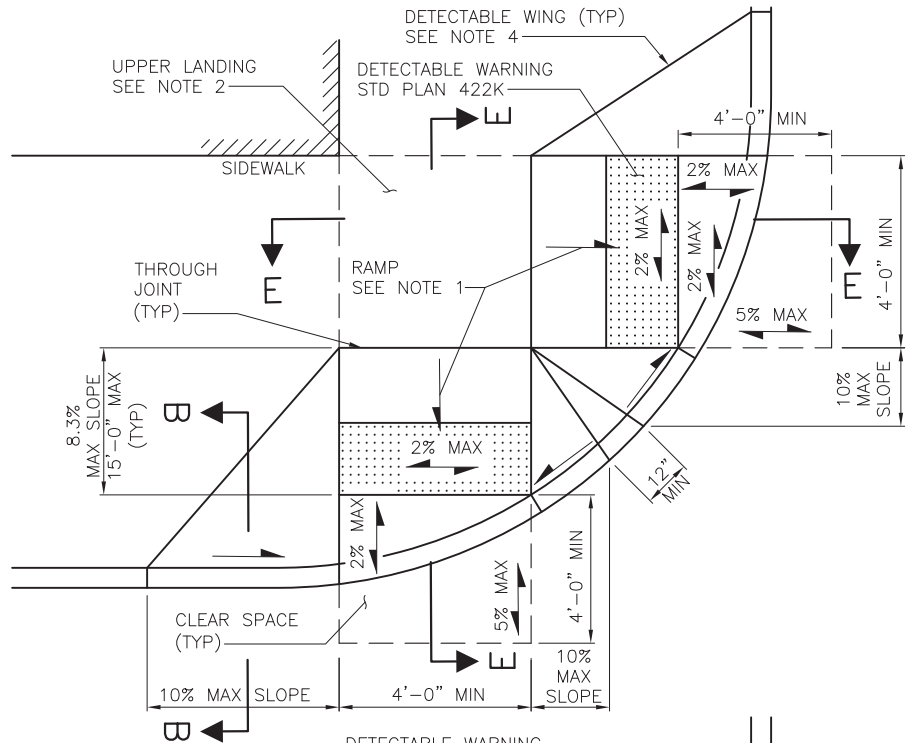

2% MAX = MAX SLOPE IN EITHER DIRECTION

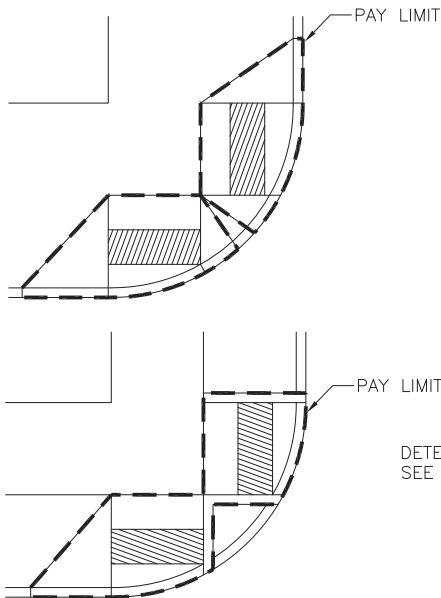

PAY LIMITS

DIRECTIONAL CURB RAMP W/ SHARED LANDING

(TYPE 422F)
422F CURB RAMP LOCATIONS

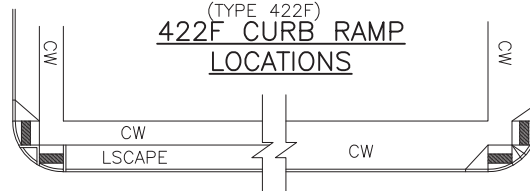

REF STD SPEC SEC 8-14



City of Seattle

NOT TO SCALE

CURB RAMP DETAILS

NOTES:

1. RAMP CENTERLINE(S) SHALL BE PARALLEL TO CROSSWALK AND/OR THE SIDEWALK.
2. UPPER LANDING AT THE TOP OF THE CURB RAMP SHALL MATCH THE FULL WIDTH OF THE RAMP AND SHALL HAVE A MINIMUM DEPTH OF 4'-0". IF THE LANDING IS LIMITED AT THE BACK-OF-SIDEWALK BY A PERMANENT VERTICAL BARRIER, THE DEPTH OF THE TURNING SPACE SHALL BE 5'-0" MINIMUM, MEASURED PARALLEL TO THE RUN OF THE CURB RAMP. SLOPE ON THE LANDING SHALL BE BETWEEN 0.5% AND 2% IN ANY DIRECTION.
3. WINGS SHALL HAVE A MAXIMUM SLOPE OF 10%. WINGS SHALL HAVE A BRUSHED FINISH PARALLEL TO THE CURB. THE CONCRETE WALK THICKENED EDGE ALONG THE CURB SHALL CONTINUE THROUGH EACH WING.
4. RAMP SURFACE SHALL HAVE A HEAVY BROOM BRUSHED SURFACE PARALLEL TO THE CURB.
5. REFER TO DETAILS 422K AND 422L FOR GENERAL NOTES AND TYPICAL SECTIONS.

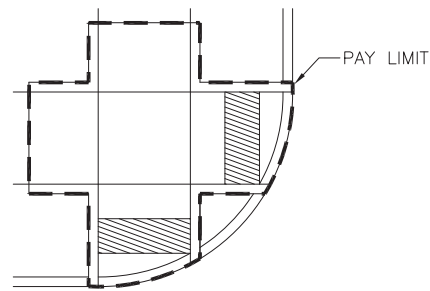
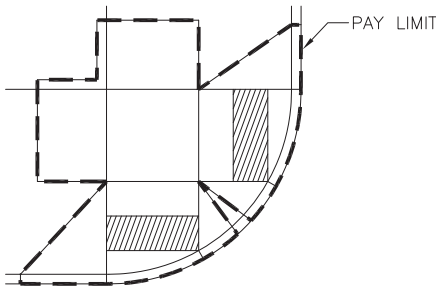
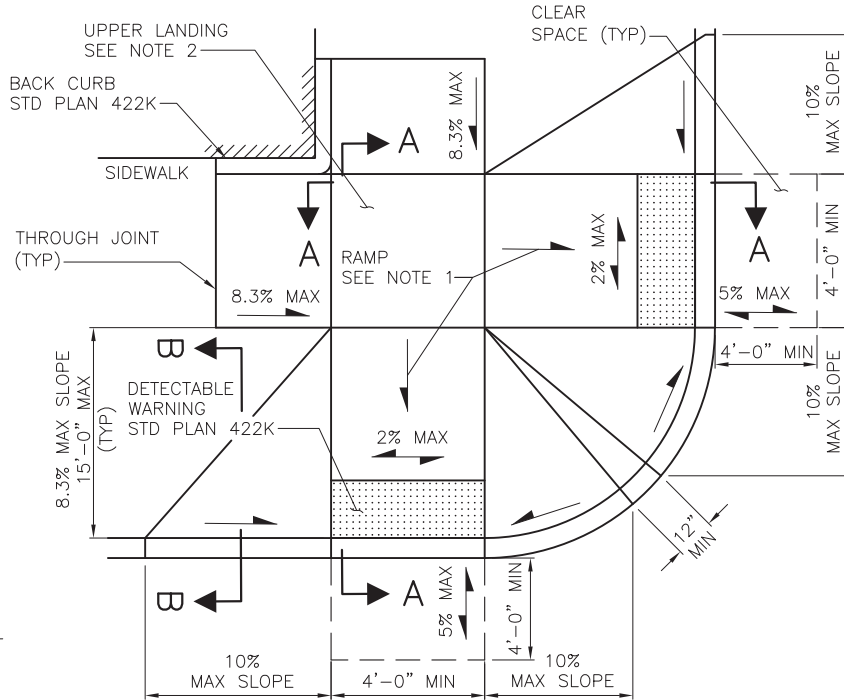

PAY LIMITS

2% MAX = MAX SLOPE IN EITHER DIRECTION

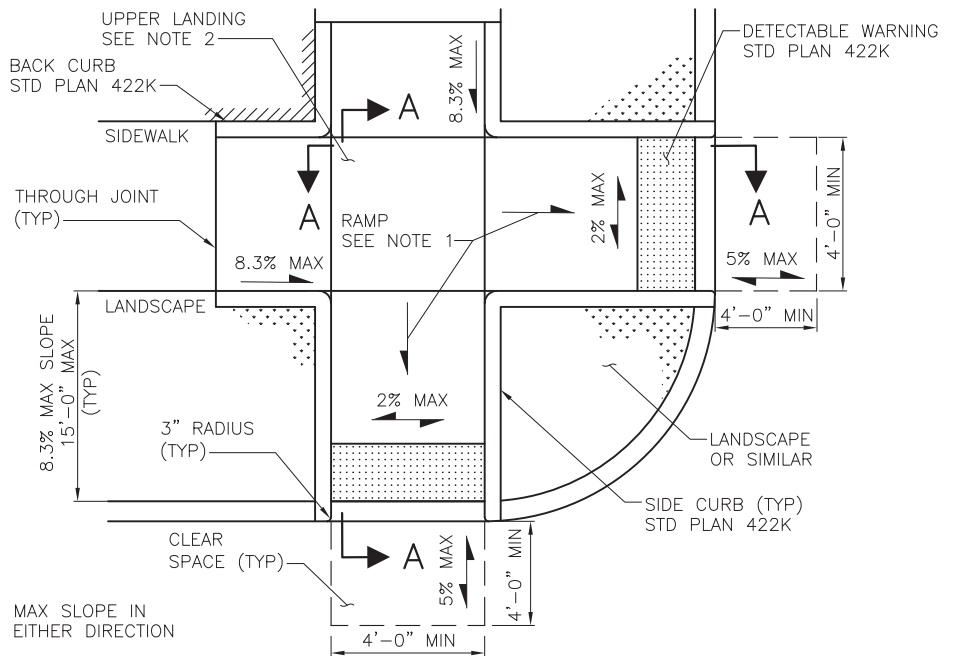

PARALLEL AND PERPENDICULAR COMBINATION CURB RAMPS W/ SHARED LANDING (TYPE 422G)

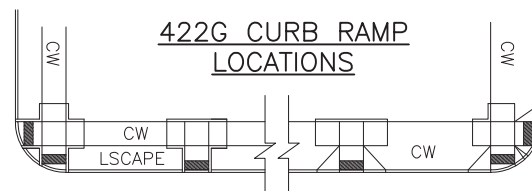

REF STD SPEC SEC 8-14



City of Seattle

NOT TO SCALE

CURB RAMP DETAILS

NOTES:

1. SHARED DIAGONAL PERPENDICULAR RAMP SHALL NOT BE INSTALLED UNLESS ALL OTHER DESIGN OPTIONS ARE UNABLE TO BE CONSTRUCTED DUE TO EXISTING SITE CONSTRAINTS.
2. RAMP CENTERLINE SHALL BE RADIAL/PERPENDICULAR TO THE ALIGNMENT OF THE FACE OF CURB.
3. UPPER LANDING AT THE TOP OF THE CURB RAMP SHALL MATCH THE FULL WIDTH OF THE RAMP AND SHALL HAVE A MINIMUM DEPTH OF 4'-0". IF THE LANDING IS LIMITED AT THE BACK-OF-SIDEWALK BY A PERMANENT VERTICAL BARRIER, THE DEPTH OF THE TURNING SPACE SHALL BE 5'-0" MINIMUM, MEASURED PARALLEL TO THE RUN OF THE CURB RAMP. SLOPE ON THE LANDING SHALL BE BETWEEN 0.5% AND 2% IN ANY DIRECTION. CLEAR SPACE AT THE BOTTOM OF THE RAMP SHALL BE 4'-0" MINIMUM IN WIDTH AND SHALL EXTEND A MINIMUM OF 4'-0" BEYOND THE RAMP LOWER GRADE BREAK. THE CLEAR SPACE SHALL FALL WHOLLY WITHIN THE LEGAL CROSSWALK, MARKED OR UNMARKED. THE CLEAR SPACE SHALL FIT BEHIND LINES EXTENDING FROM THE FACE OF CURB RUNNING PARALLEL TO EACH ROADWAY. THERE IS NO ALLOWABLE EXEMPTION FOR MINIMUM CLEAR SPACE REQUIREMENTS AT SHARED DIAGONAL PERPENDICULAR CURB RAMP.
5. WINGS SHALL HAVE A MAXIMUM SLOPE OF 10%. WINGS SHALL HAVE A BRUSHED FINISH PARALLEL TO THE CURB. THE CONCRETE WALK THICKENED EDGE ALONG THE CURB SHALL CONTINUE THROUGH EACH WING.
6. RAMP SURFACE SHALL HAVE A HEAVY BROOM BRUSHED SURFACE PARALLEL TO THE CURB.
7. REFER TO DETAILS 422K AND 422L FOR GENERAL NOTES AND TYPICAL SECTIONS.

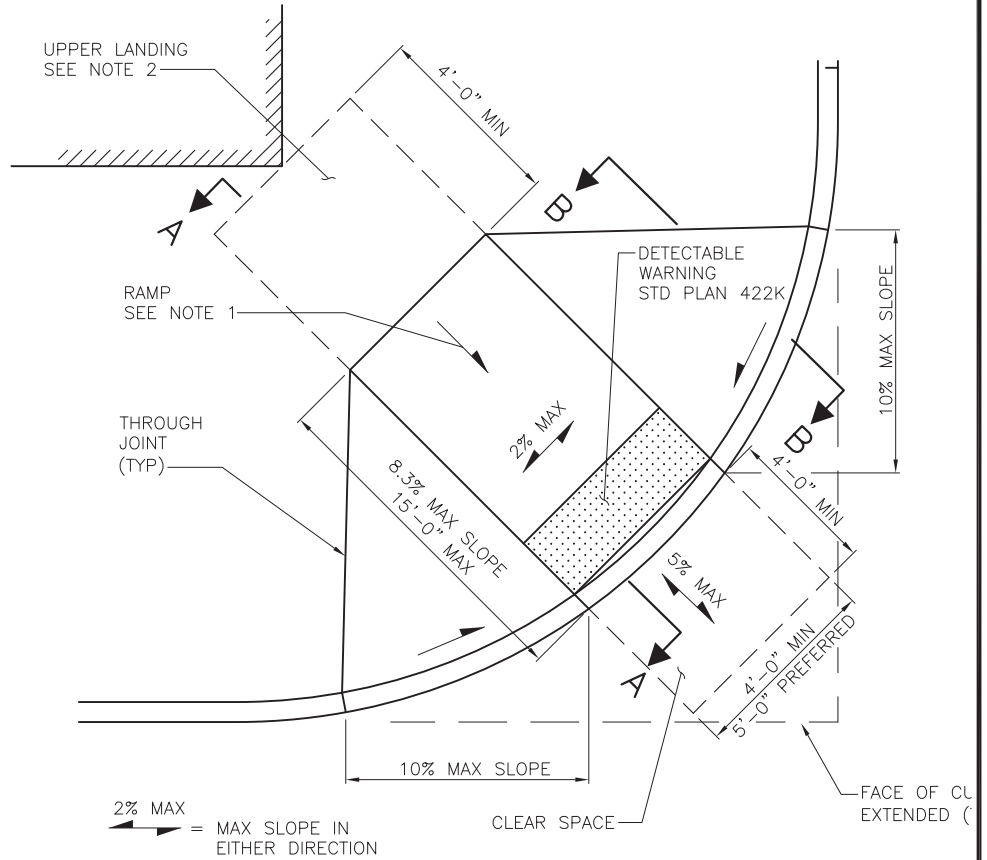

SHARED DIAGONAL PERPENDICULAR CURB RAMP
(TYPE 422H)

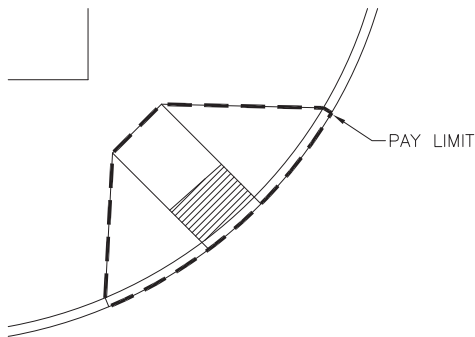

PAY LIMITS

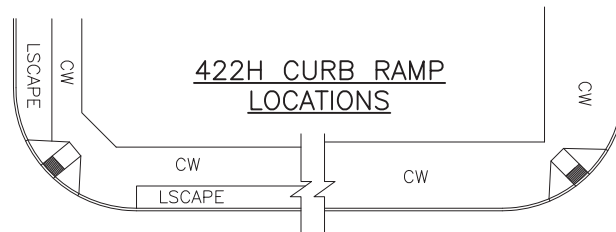

REF STD SPEC SEC 8-14



City of Seattle

NOT TO SCALE

CURB RAMP DETAILS

NOTES:

1. THE SIDEWALK SHALL TRANSITION DOWN TO THE ROADWAY WITH A MAXIMUM RUNNING SLOPE OF 5%. THE CROSS SLOPE ON THE TRANSITION SHALL NOT EXCEED 2% AT ANY POINT.
2. A MINIMUM BYPASS ROUTE SHALL BE PROVIDED AT THE TOP OF THE BLENDED TRANSITION WITH A MINIMUM WIDTH OF 4'-0". THE CROSS SLOPE OF THE BYPASS ROUTE SHALL NOT EXCEED 2% IN ANY DIRECTION.
3. WINGS SHALL HAVE A MAXIMUM SLOPE OF 10%. WINGS SHALL HAVE A BRUSHED FINISH PARALLEL TO THE CURB. THE CONCRETE WALK THICKENED EDGE ALONG THE CURB SHALL CONTINUE THROUGH EACH WING.
4. BLENDED TRANSITION SURFACE SHALL HAVE A HEAVY BROOM BRUSHED SURFACE RADIAL/PERPENDICULAR TO THE CURB.
5. REFER TO DETAILS 422K AND 422L FOR GENERAL NOTES AND TYPICAL SECTION D.

2% MAX
 = MAX SLOPE IN EITHER DIRECTION

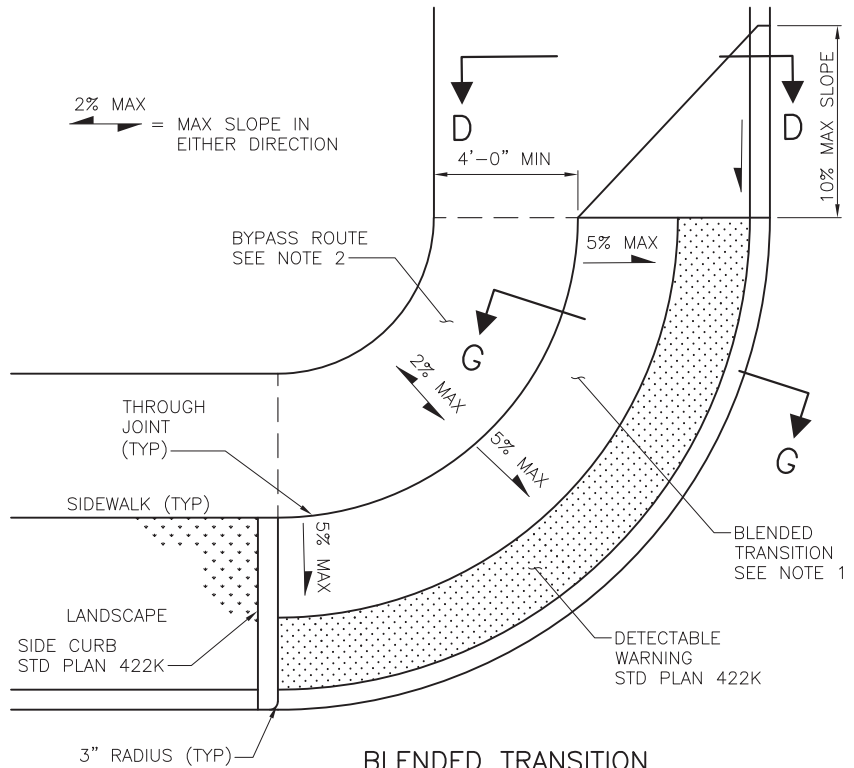

BLENDED TRANSITION
 (TYPE 422I)

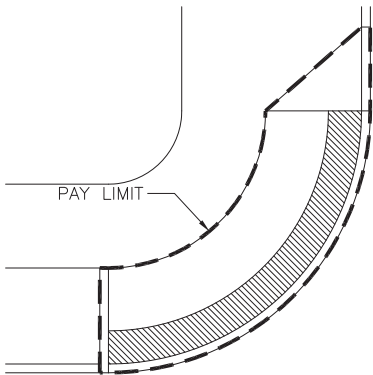
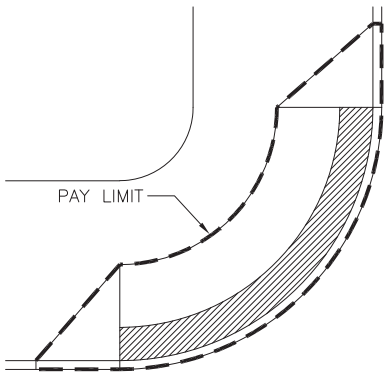

PAY LIMITS

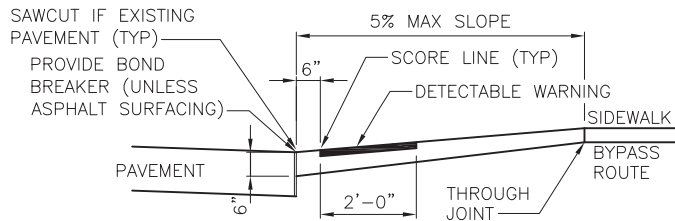

SECTION G-G

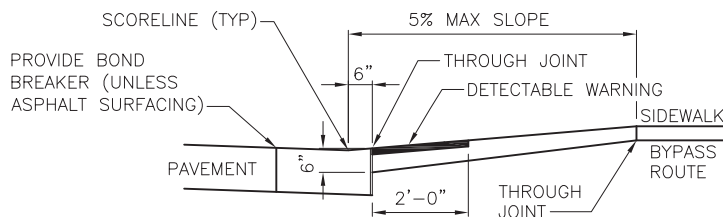

SECTION G-G

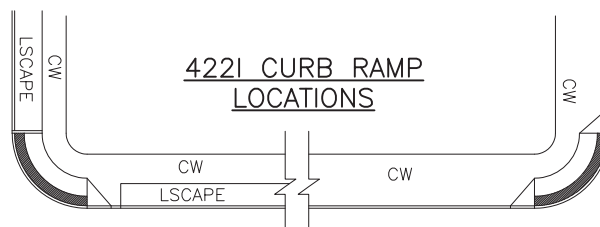

REF STD SPEC SEC 8-14



City of Seattle

NOT TO SCALE

CURB RAMP DETAILS

NOTES:

1. SIZE, SHAPE, AND/OR DIMENSIONS OF CHANNELIZING ISLANDS OR PEDESTRIAN REFUGE ISLANDS MAY VARY. DETAILS SHOWN ARE INTENDED TO SHOW MINIMUM REQUIRED CLEARANCES AND DETECTABLE WARNING SURFACE PLACEMENT LOCATIONS.
2. ACCESS THROUGH CHANNELIZING ISLANDS OR PEDESTRIAN REFUGE ISLANDS MAY BE CUT-THROUGH OR ACCESS MAY BE PROVIDED USING STANDARD CURB RAMP DETAILS.
3. AT PEDESTRIAN REFUGE ISLANDS, DETECTABLE WARNING IS NOT TO BE INSTALLED IF THE REFUGE AREA IS LESS THAN 6'-0" IN DEPTH (IN THE DIRECTION OF TRAVEL).
4. PROVIDE A MINIMUM 4'-0" WIDTH x 4'-0" DEPTH CLEAR SPACE FOR ACCESS FROM THE CHANNELIZING ISLAND OR PEDESTRIAN REFUGE ISLAND FOR EACH CROSSWALK.

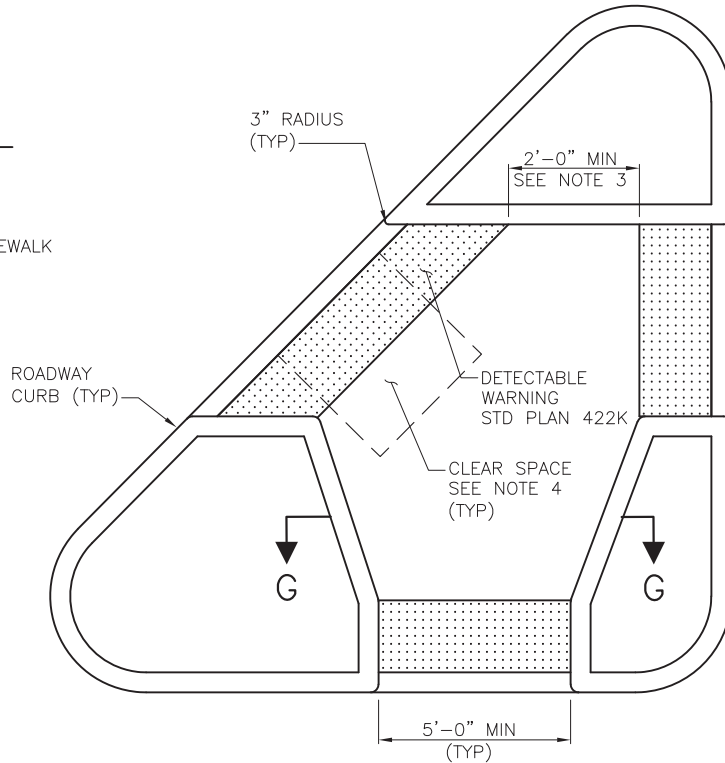
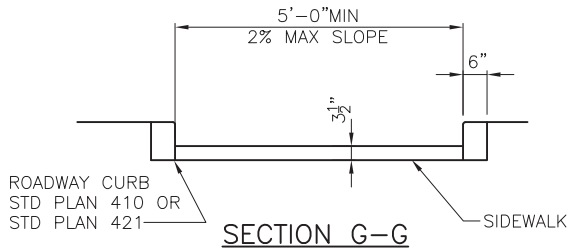
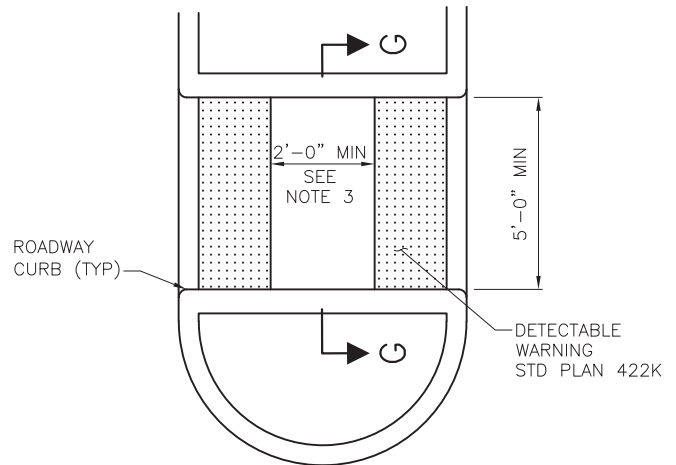

ISLAND CUT-THROUGHS
(TYPE 422J)

REF STD SPEC SEC 8-14



City of Seattle

NOT TO SCALE

CURB RAMP DETAILS

CURB RAMP GENERAL NOTES:

1. TWO CURB RAMP SHALL BE INSTALLED AT EACH CORNER UNLESS OTHERWISE DIRECTED BY ENGINEER. SHARED DIAGONAL PERPENDICULAR RAMPS SHALL NOT BE INSTALLED UNLESS ALL OTHER DESIGN OPTIONS ARE UNABLE TO BE CONSTRUCTED DUE TO EXISTING SITE CONSTRAINTS.
2. CURB RAMPS SHALL BE AS CLOSELY ALIGNED WITH THE SIDEWALK AND THE PEDESTRIAN STREET CROSSING SERVED AS POSSIBLE.
3. CURB RAMP SHALL BE CONSTRUCTED WITH COMPANION RAMP ON OPPOSITE SIDE OF THE ROADWAY WHERE NO RAMP IS PROVIDED UNLESS OTHERWISE DIRECTED BY ENGINEER.
4. RAMPS SHALL TYPICALLY HAVE A MAXIMUM RUNNING SLOPE OF 8.3% AND A MINIMUM WIDTH OF 4'-0" UNLESS OTHERWISE DIRECTED BY ENGINEER. THE CROSS SLOPE OF RAMPS SHALL BE MAXIMUM OF 2%. CURB RAMPS ARE NOT REQUIRED TO EXCEED A LENGTH OF 15 FEET UNLESS OTHERWISE DIRECTED BY ENGINEER.*
5. GRADE BREAKS AT THE TOP AND THE BOTTOM OF CURB RAMP RUNS MUST BE PERPENDICULAR TO THE PATH OF TRAVEL. CURB RAMP RUNS ARE DEFINED BY RUNNING SLOPES THAT EXCEED 5% BUT ARE NO MORE THAN 8.3%. SURFACES ABUTTING AT CURB RAMP GRADE BREAKS SHALL BE FLUSH.
6. AREAS ADJACENT TO CURB RAMPS OR CURB RAMP LANDINGS USABLE BY PEDESTRIANS SHALL COMPLY WITH STANDARD PLAN SIDEWALK SLOPE LIMITS OR A CURB RAMP WING MUST BE PROVIDED AS SHOWN IN THE APPLICABLE CURB RAMP DETAILS. THE INSTALLATION OF CURBED EDGES ARE NOT REQUIRED BUT MAY BE USED AT THE SIDES OR BACKS OF CURB RAMPS OR CURB RAMP LANDING WHERE THE ADJACENT SURFACE IS LANDSCAPED OR OTHERWISE NOT USABLE BY PEDESTRIANS.
7. THE COUNTER SLOPE OF THE GUTTER OR THE STREET AT THE BOTTOM OF CURB RAMP RUNS SHALL BE 5% MAXIMUM. IF TURNING OR CHANGE OF ORIENTATION IS REQUIRED WITHIN THE PEDESTRIAN CROSSING AT THE BOTTOM OF CURB RAMP RUNS, THE SLOPE SHALL BE 2% MAXIMUM IN ANY DIRECTION FOR A MINIMUM 4'-0" WIDTH x 4'-0" DEPTH MEASURED FROM THE RAMP BOTTOM GRADE BREAK.
8. CURB RAMPS WITH RAMP RUNS THAT TERMINATE AT THE ENTRANCE TO THE PEDESTRIAN STREET CROSSING SHALL HAVE A CLEAR SPACE AT THE BOTTOM OF THE RAMP 4'-0" MINIMUM IN WIDTH AND SHALL EXTEND A MINIMUM 4'-0" BEYOND THE RAMP LOWER GRADE BREAK. THE CLEAR SPACE SHALL FALL WHOLLY WITHIN THE LEGAL CROSSWALK, MARKED OR UNMARKED.
9. DETECTABLE WARNING SHALL BE PROVIDED AT CURB RAMPS AND AT LOCATIONS WHERE THE SIDEWALK AND ROADWAY ARE FLUSH. THE DETECTABLE WARNING SURFACE SHALL HAVE A TRUNCATED DOME PATTERN AS SHOWN, WITH A MINIMUM DEPTH OF 2'-0", AND SHALL BE PLACED AT THE BACK OF CURB BUT NO MORE THAN 8" FROM THE FACE OF CURB FOR MONOLITHIC CURBS OR ATYPICAL CURB WIDTHS. DETECTABLE WARNING SHALL MATCH THE WIDTH OF THE RAMP RUN OR THE OPENING WHERE THE SIDEWALK AND ROADWAY ARE FLUSH. THE TRUNCATED DOMES ON THE DETECTABLE WARNING SURFACE SHOULD ALIGN WITH THE CURB RAMP RUN OR THE DIRECTION OF TRAVEL. DOMES MAY BE ON A RADIAL GRID PATTERN WHERE THE DETECTABLE WARNING SURFACE IS PLACED AT CURB RADII.
10. DETECTABLE WARNING COLOR SHALL BE "FEDERAL SAFETY YELLOW", UNLESS OTHERWISE DIRECTED BY ENGINEER.
11. DETECTABLE WARNING SURFACES SHOULD GENERALLY NOT BE CUT OR ALTERED TO FIT UNLESS THERE IS NO ALTERNATIVE AVAILABLE. IF REQUIRED, CUT OR ALTER THE DETECTABLE WARNING SURFACE PER THE MANUFACTURER'S DIRECTIONS. DETECTABLE WARNING SURFACES PLACED AT CURB RADII SHALL MATCH THE CURB RADII WITHOUT GAPS OR INCONSISTENCIES IN PLACEMENT.
12. AVOID LOCATED HANDHOLES, UTILITY CASTINGS, OR ANY OTHER OBSTRUCTIONS IN THE CURB RAMP RUN(S) OR LANDING(S). IF NECESSARY DUE TO EXISTING CONSTRAINTS, HANDHOLES, UTILITY CASTINGS, OR OTHER OBSTRUCTIONS MAY BE LOCATED WITHIN A RAMP RUN, LANDING, OR TURNING SPACE BUT MUST ADHERE TO SURFACE REQUIREMENTS. LEVEL CHANGES BETWEEN SURFACES MUST NOT EXCEED 1/4" OR 1/2" WITH A 1:2 BEVEL. GAPS BETWEEN SURFACES OR GRATINGS MAY NOT EXCEED 1/2". SURFACES MUST BE FIRM, STABLE, AND SLIP RESISTANT.
13. HANDHOLES, UTILITY CASTINGS, OR OTHER OBSTRUCTIONS SHALL NOT REDUCE THE REQUIRED DEPTH OF DETECTABLE WARNING.
14. POLES, HYDRANTS AND OTHER ABOVE GROUND OBSTRUCTIONS SHALL HAVE A MINIMUM LATERAL CLEARANCE OF 1'-0" FROM THE UPPER LANDING AND RAMP SURFACE.
15. ALL CHANGES IN LEVEL ACROSS JOINTS SHALL BE FLUSH. ANY DIFFERENCE IN ELEVATION OF 3/16 INCH OR GREATER SHALL BE REPAIRED OR REPLACED.
16. CURB RAMPS SHALL BE DESIGNED AND CONSTRUCTED SO THAT WATER WILL NOT ACCUMULATE ON RAMP SURFACES. GUTTER FLOW LINE SHALL BE SURVEYED BY THE CONTRACTOR PRIOR TO CONSTRUCTION TO ENSURE PONDING OF WATER SHALL NOT OCCUR AT THE BOTTOM OF CURB RAMPS OR AT CURB RAMP LOWER LANDINGS.
17. ALL SLOPE GRADES SHALL BE MEASURED OFF THE HORIZON-LINE. IF EXISTING SITE CONDITIONS CONFLICT WITH OBTAINING GRADES SHOWN, THE DESIGNER / CONTRACTOR SHALL MAKE MINIMUM ADJUSTMENTS TO THE GRADES SHOWN TO MEET EXISTING SITE CONDITIONS; ADJUSTMENTS ARE SUBJECT TO ENGINEER APPROVAL.

* IT IS GENERALLY PREFERRED THAT CURB RAMPS, CURB RAMP LANDINGS, AND ASSOCIATED FEATURES NOT BE DESIGNED TO THE MINIMUM OR MAXIMUM ALLOWABLE DIMENSION AND/OR SLOPE TO ALLOW FOR A LIMITED MARGIN OF ERROR DURING CONSTRUCTION.

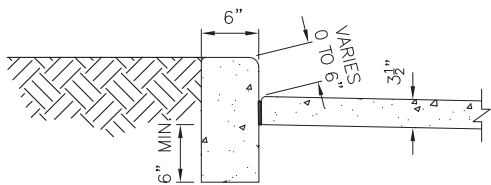

SIDE CURB DETAIL

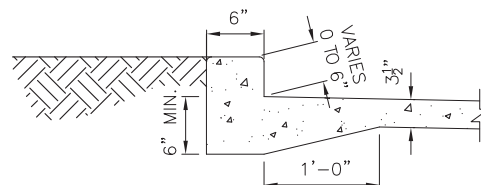

BACK CURB DETAIL

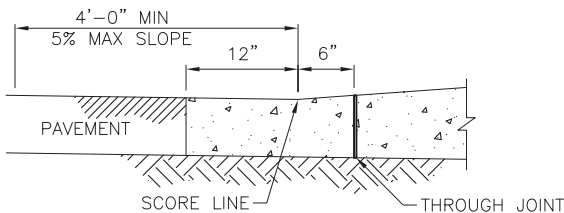

DEPRESSED CURB AND GUTTER DETAIL

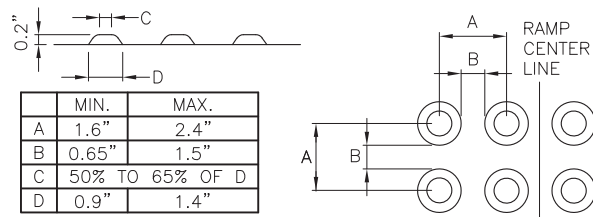

DETECTABLE WARNING TRUNCATED DOMES PATTERN

REF STD SPEC SEC 8-14



City of Seattle

NOT TO SCALE

CURB RAMP DETAILS

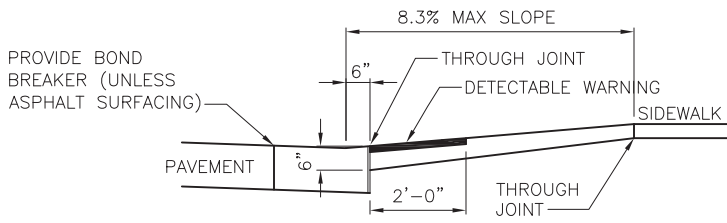

SECTION A-A

DEPRESSED CURB & GUTTER SEPARATE FROM RAMP.

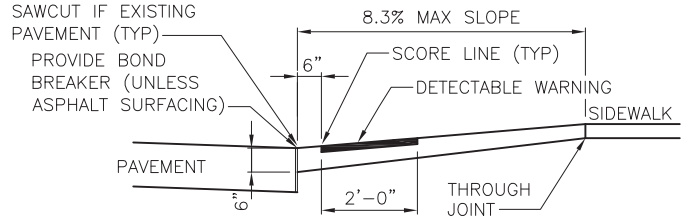

SECTION A-A

CURB MONOLITHIC WITH RAMP. NEW PAVEMENT BLOCKED OUT FULL DEPTH. EXISTING PAVEMENT REMOVED AT FACE OF CURB

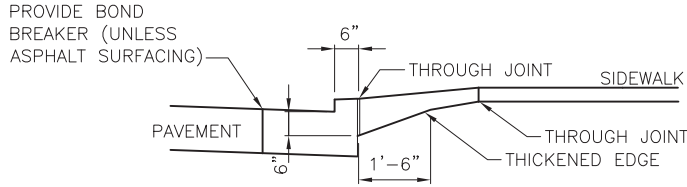

SECTION B-B

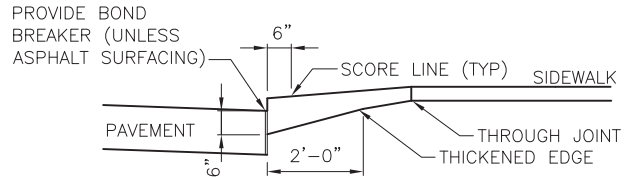

SECTION B-B

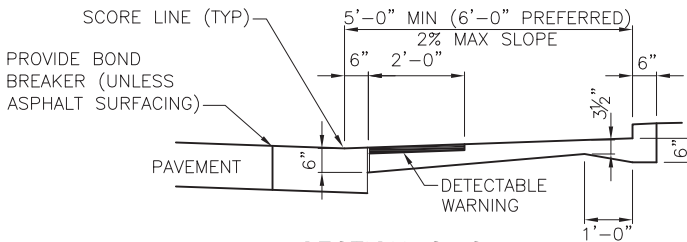

SECTION C-C

DEPRESSED CURB & GUTTER SEPARATE FROM RAMP.

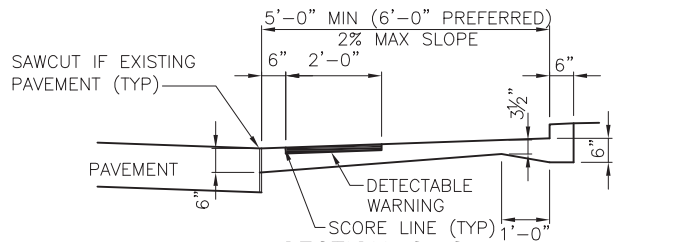

SECTION C-C

CURB MONOLITHIC WITH RAMP. NEW PAVEMENT BLOCKED OUT FULL DEPTH. EXISTING PAVEMENT REMOVED AT FACE OF CURB

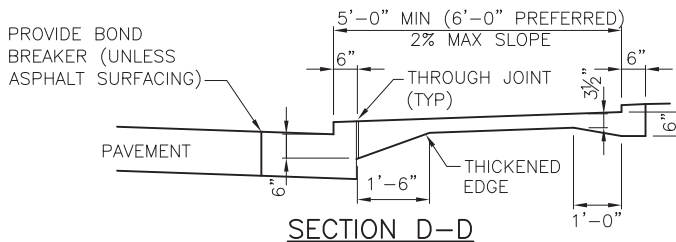

SECTION D-D

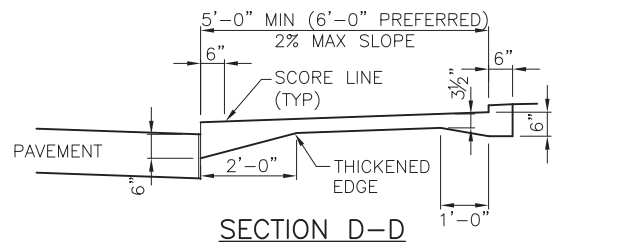

SECTION D-D

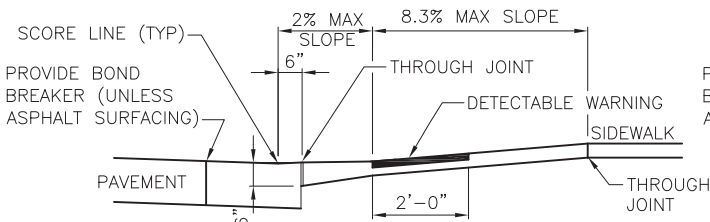

SECTION E-E

DEPRESSED CURB & GUTTER SEPARATE FROM RAMP.

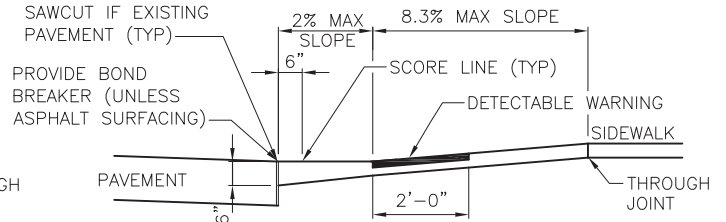

SECTION E-E

CURB MONOLITHIC WITH RAMP. NEW PAVEMENT BLOCKED OUT FULL DEPTH. EXISTING PAVEMENT REMOVED AT FACE OF CURB

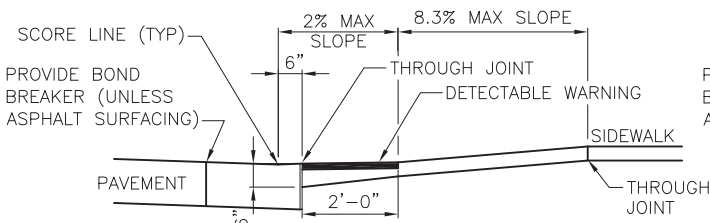

SECTION F-F

DEPRESSED CURB & GUTTER SEPARATE FROM RAMP

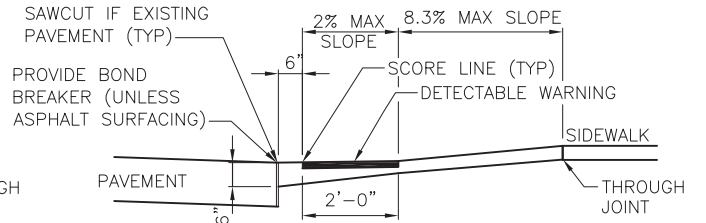

SECTION F-F

CURB MONOLITHIC WITH RAMP. NEW PAVEMENT BLOCKED OUT FULL DEPTH. EXISTING PAVEMENT REMOVED AT FACE OF CURB

REF STD SPEC SEC 8-14



City of Seattle

NOT TO SCALE

CURB RAMP SECTIONS