

Part III—Building Planning and Construction

CHAPTER 3 BUILDING PLANNING

User note:

About this chapter: Chapter 3 contains a wide array of building planning requirements that are critical to designing a safe and usable building. This includes, but is not limited to, requirements related to: general structural design, fire-resistant construction, light, ventilation, sanitation, plumbing fixture clearances, minimum room area and ceiling height, safety glazing, means of egress, automatic fire sprinkler systems, smoke and carbon monoxide alarm systems, accessibility, solar energy systems, swimming pools, spas and hot tubs.

SECTION R301 DESIGN CRITERIA

R301.1 Application. Buildings and structures, and parts thereof, shall be constructed to safely support all loads, including dead loads, live loads, roof loads, flood loads, snow loads, wind loads and seismic loads as prescribed by this code. The construction of buildings and structures in accordance with the provisions of this code shall result in a system that provides a complete load path that meets the requirements for the transfer of loads from their point of origin through the load-resisting elements to the foundation. Buildings and structures constructed as prescribed by this code are deemed to comply with the requirements of this section.

R301.1.1 Alternative provisions. As an alternative to the requirements in Section R301.1, the following standards are permitted subject to the limitations of this code and the limitations therein. Where engineered design is used in conjunction with these standards, the design shall comply with the *International Building Code*.

1. AWC *Wood Frame Construction Manual* (WFCM).
2. AISI *Standard for Cold-Formed Steel Framing—Prescriptive Method for One- and Two-Family Dwellings* (AISIS230).
3. ICC *Standard on the Design and Construction of Log Structures* (ICC 400).

R301.1.2 Construction systems. The requirements of this code are based on platform and balloon-frame construction for light-frame buildings. The requirements for concrete and masonry buildings are based on a balloon framing system. Other framing systems must have equivalent detailing to ensure force transfer, continuity and compatible deformations.

R301.1.3 Engineered design. Where a building of otherwise conventional construction contains structural elements exceeding the limits of Section R301 or otherwise not conforming to this code, these elements shall be designed in accordance with accepted engineering practice. The extent of such design need only demonstrate compliance of nonconventional elements with other applicable provisions and shall be compatible with the performance of the conventional framed system. Engineered design in accordance with the *International Building Code* is permitted for buildings and structures, and parts thereof, included in the scope of this code.

[W][S] R301.2 Climatic and geographic design criteria. Buildings shall be constructed in accordance with the provisions of this code as limited by the provisions of this section. Additional criteria ~~((shall be))~~ are established ~~((by the local jurisdiction and set forth))~~ in Table R301.2(1).

[S] TABLE R301.2(1)
CLIMATIC AND GEOGRAPHIC DESIGN CRITERIA

GROUND SNOW LOAD ^d	WIND DESIGN				SEISMIC DESIGN CATEGORY ^f	SUBJECT TO DAMAGE FROM			WINTER DESIGN TEMP ^e	ICE BARRIER UNDERLAYMENT REQUIRED ^h	FLOOD HAZARDS ^g	AIR FREEZING INDEX ⁱ	MEAN ANNUAL TEMP ^j		
	Speed ^d (mph)	Topographic effects ^k	Special wind region ^l	Windborne debris zone ^m		Weathering ^a	Frost line depth ^b	Termite ^c							
25 psf	85	Yes	No	No	D ₂	Moderate	12"	none to slight	24° F	No	(a) 1989 (b) May 16, 1995	250	52.8° F		
MANUAL J DESIGN CRITERIA ⁿ															
Elevation		Latitude		Winter heating		Summer cooling		Altitude correction factor		Indoor design temperature		Design temperature cooling		Heating temperature difference	
—		—		—		—		—		—		—		—	
Cooling temperature difference		Wind velocity heating		Wind velocity cooling		Coincident wet bulb		Daily range		Winter humidity		Summer humidity		—	
—		—		—		—		—		—		—		—	

For SI: 1 pound per square foot = 0.0479 kPa, 1 mile per hour = 0.447 m/s.

- a. Where weathering requires a higher strength concrete or grade of masonry than necessary to satisfy the structural requirements of this code, the frost line depth strength required for weathering shall govern. The weathering column shall be filled in with the weathering index, “negligible,” “moderate” or “severe” for concrete as determined from Figure R301.2(4). The grade of masonry units shall be determined from ASTM C34, C55, C62, C73, C90, C129, C145, C216 or C652.
- b. Where the frost line depth requires deeper footings than indicated in Figure R403.1(1), the frost line depth strength required for weathering shall govern. The jurisdiction shall fill in the frost line depth column with the minimum depth of footing below finish grade.
- c. The jurisdiction shall fill in this part of the table to indicate the need for protection depending on whether there has been a history of local subterranean termite damage.
- d. The jurisdiction shall fill in this part of the table with the wind speed from the basic wind speed map [Figure R301.2(5)A]. Wind exposure category shall be determined on a site-specific basis in accordance with Section R301.2.1.4.
- e. ~~((The outdoor design dry bulb temperature shall be selected from the columns of 97 1/2 percent values for winter from Appendix D of the International Plumbing Code. Deviations from the Appendix D temperatures shall be permitted to reflect local climates or local weather experience as determined by the building official.))~~ The winter design temperature is taken from the *International Energy Conservation Code*. [Also see Figure R301.2(4).]
- f. The jurisdiction shall fill in this part of the table with the seismic design category determined from Section R301.2.2.1.
- g. The jurisdiction shall fill in this part of the table with (a) the date of the jurisdiction’s entry into the National Flood Insurance Program (date of adoption of the first code or ordinance for management of flood hazard areas), (b) the date(s) of the Flood Insurance Study ~~((and (e) the panel numbers and dates of the currently effective FIRMs and FBFMs or other flood hazard map adopted by the authority having jurisdiction, as amended))~~. Flood hazard areas include areas mapped by Seattle Public Utilities.
- h. In accordance with Sections R905.1.2, R905.4.3.1, R905.5.3.1, R905.6.3.1, R905.7.3.1 and R905.8.3.1, where there has been a history of local damage from the effects of ice damming, the jurisdiction shall fill in this part of the table with “YES.” Otherwise, the jurisdiction shall fill in this part of the table with “NO.”
- i. The jurisdiction shall fill in this part of the table with the 100-year return period air freezing index (BF-days) from Figure R403.3(2) or from the 100-year (99 percent) value on the National Climatic Data Center data table “Air Freezing Index-USA Method (Base 32°F).”
- j. The jurisdiction shall fill in this part of the table with the mean annual temperature from the National Climatic Data Center data table “Air Freezing Index-USA Method (Base 32°F).”
- k. In accordance with Section R301.2.1.5, where there is local historical data documenting structural damage to buildings due to topographic wind speed-up effects, the jurisdiction shall fill in this part of the table with “YES.” Otherwise, the jurisdiction shall indicate “NO” in this part of the table.
- l. In accordance with Figure R301.2(5)A, where there is local historical data documenting unusual wind conditions, the jurisdiction shall fill in this part of the table with “YES” and identify any specific requirements. Otherwise, the jurisdiction shall indicate “NO” in this part of the table.
- m. In accordance with Section R301.2.1.2 the jurisdiction shall indicate the wind-borne debris wind zone(s). Otherwise, the jurisdiction shall indicate “NO” in this part of the table.
- n. The jurisdiction shall fill in these sections of the table to establish the design criteria using Table 1a or 1b from ACCA Manual J or established criteria determined by the jurisdiction.
- o. The jurisdiction shall fill in this section of the table using the Ground Snow Loads in Figure R301.2(6).

TABLE R301.2(2)
COMPONENT AND CLADDING LOADS FOR A BUILDING WITH A MEAN
ROOF HEIGHT OF 30 FEET LOCATED IN EXPOSURE B (ASD) (psf)^{a, b, c, d, e}

	ZONE	EFFECTIVE WIND AREA (feet ²)	ULTIMATE DESIGN WIND SPEED, V _{ULT} (mph)																		
			110		115		120		130		140		150		160		170		180		
Roof 0 to 7 degrees	1	10	10.0	-13.0	10.0	-14.0	10.0	-15.0	10.0	-18.0	10.0	-21.0	9.9	-24.0	11.2	-27.0	12.6	-31.0	14.2	-35.0	
	1	20	10.0	-12.0	10.0	-13.0	10.0	-15.0	10.0	-17.0	10.0	-20.0	9.2	-23.0	10.6	-26.0	11.9	-30.0	13.3	-34.1	
	1	50	10.0	-12.0	10.0	-13.0	10.0	-14.0	10.0	-17.0	10.0	-19.0	8.5	-22.0	10.0	-26.0	10.8	-29.0	12.2	-32.9	
	1	100	10.0	-11.0	10.0	-13.0	10.0	-14.0	10.0	-16.0	10.0	-19.0	7.8	-22.0	10.0	-25.0	10.0	-28.0	11.3	-32.0	
	2	10	10.0	-21.0	10.0	-23.0	10.0	-26.0	10.0	-30.0	10.0	-35.0	9.9	-40.0	11.2	-46.0	12.6	-52.0	14.2	-58.7	
	2	20	10.0	-19.0	10.0	-21.0	10.0	-23.0	10.0	-27.0	10.0	-31.0	9.2	-36.0	10.6	-41.0	11.9	-46.0	13.3	-52.4	
	2	50	10.0	-16.0	10.0	-18.0	10.0	-19.0	10.0	-23.0	10.0	-26.0	8.5	-30.0	10.0	-34.0	10.8	-39.0	12.2	-44.1	
	2	100	10.0	-14.0	10.0	-15.0	10.0	-16.0	10.0	-19.0	10.0	-22.0	7.8	-26.0	10.0	-30.0	10.0	-33.0	11.3	-37.9	
	3	10	10.0	-33.0	10.0	-36.0	10.0	-39.0	10.0	-46.0	10.0	-53.0	9.9	-61.0	11.2	-69.0	12.6	-78.0	14.2	-88.3	
	3	20	10.0	-27.0	10.0	-29.0	10.0	-32.0	10.0	-38.0	10.0	-44.0	9.2	-50.0	10.6	-57.0	11.9	-65.0	13.3	-73.1	
	3	50	10.0	-19.0	10.0	-21.0	10.0	-23.0	10.0	-27.0	10.0	-32.0	8.5	-36.0	10.0	-41.0	10.8	-47.0	12.2	-53.1	
	3	100	10.0	-14.0	10.0	-15.0	10.0	-16.0	10.0	-19.0	10.0	-22.0	7.8	-26.0	10.0	-30.0	10.0	-33.0	11.3	-37.9	
	Roof > 7 to 27 degrees	1	10	10.0	-11.0	10.0	-13.0	10.0	-14.0	10.5	-16.0	12.2	-19.0	14.0	-22.0	15.9	-25.0	17.9	-28.0	20.2	-32.0
		1	20	10.0	-11.0	10.0	-12.0	10.0	-13.0	10.0	-16.0	11.1	-18.0	12.8	-21.0	14.5	-24.0	16.4	-27.0	18.4	-31.1
		1	50	10.0	-11.0	10.0	-12.0	10.0	-13.0	10.0	-15.0	10.0	-18.0	11.1	-20.0	12.7	-23.0	14.3	-26.0	16.0	-29.9
1		100	10.0	-10.0	10.0	-11.0	10.0	-12.0	10.0	-15.0	10.0	-17.0	9.9	-20.0	11.2	-22.0	12.6	-25.0	14.2	-29.0	
2		10	10.0	-20.0	10.0	-22.0	10.0	-24.0	10.5	-29.0	12.2	-33.0	14.0	-38.0	15.9	-44.0	17.9	-49.0	20.2	-55.8	
2		20	10.0	-19.0	10.0	-20.0	10.0	-22.0	10.0	-26.0	11.1	-31.0	12.8	-35.0	14.5	-40.0	16.4	-45.0	18.4	-51.2	
2		50	10.0	-16.0	10.0	-18.0	10.0	-20.0	10.0	-23.0	10.0	-27.0	11.1	-31.0	12.7	-35.0	14.3	-40.0	16.0	-45.4	
2		100	10.0	-15.0	10.0	-16.0	10.0	-18.0	10.0	-21.0	10.0	-24.0	9.9	-28.0	11.2	-32.0	12.6	-36.0	14.2	-40.9	
3		10	10.0	-30.0	10.0	-33.0	10.0	-36.0	10.5	-43.0	12.2	-49.0	14.0	-57.0	15.9	-65.0	17.9	-73.0	20.2	-82.4	
3		20	10.0	-28.0	10.0	-31.0	10.0	-34.0	10.0	-40.0	11.1	-46.0	12.8	-53.0	14.5	-60.0	16.4	-68.0	18.4	-77.0	
3		50	10.0	-26.0	10.0	-28.0	10.0	-31.0	10.0	-36.0	10.0	-42.0	11.1	-48.0	12.7	-55.0	14.3	-62.0	16.0	-69.9	
3		100	10.0	-24.0	10.0	-26.0	10.0	-28.0	10.0	-33.0	10.0	-39.0	9.9	-44.0	11.2	-51.0	12.6	-57.0	14.2	-64.6	
Roof > 27 to 45 degrees		1	10	11.9	-13.0	13.1	-14.0	14.2	-15.0	16.7	-18.0	19.4	-21.0	22.2	-24.0	25.3	-27.0	28.5	-31.0	32.0	-35.0
		1	20	11.6	-12.0	12.7	-13.0	13.8	-14.0	16.2	-17.0	18.8	-20.0	21.6	-23.0	24.6	-26.0	27.7	-29.0	31.1	-33.2
		1	50	11.2	-11.0	12.2	-12.0	13.3	-13.0	15.6	-16.0	18.1	-18.0	20.8	-21.0	23.6	-24.0	26.7	-27.0	29.9	-30.8
	1	100	10.9	-10.0	11.9	-11.0	12.9	-12.0	15.1	-15.0	17.6	-17.0	20.2	-20.0	22.9	-22.0	25.9	-25.0	29.0	-29.0	
	2	10	11.9	-15.0	13.1	-16.0	14.2	-18.0	16.7	-21.0	19.4	-24.0	22.2	-28.0	25.3	-32.0	28.5	-36.0	32.0	-40.9	
	2	20	11.6	-14.0	12.7	-16.0	13.8	-17.0	16.2	-20.0	18.8	-23.0	21.6	-27.0	24.6	-30.0	27.7	-34.0	31.1	-39.1	
	2	50	11.2	-13.0	12.2	-15.0	13.3	-16.0	15.6	-19.0	18.1	-22.0	20.8	-25.0	23.6	-29.0	26.7	-32.0	29.9	-36.8	
	2	100	10.9	-13.0	11.9	-14.0	12.9	-15.0	15.1	-18.0	17.6	-21.0	20.2	-24.0	22.9	-27.0	25.9	-31.0	29.0	-35.0	
	3	10	11.9	-15.0	13.1	-16.0	14.2	-18.0	16.7	-21.0	19.4	-24.0	22.2	-28.0	25.3	-32.0	28.5	-36.0	32.0	-40.9	
	3	20	11.6	-14.0	12.7	-16.0	13.8	-17.0	16.2	-20.0	18.8	-23.0	21.6	-27.0	24.6	-30.0	27.7	-34.0	31.1	-39.1	
	3	50	11.2	-13.0	12.2	-15.0	13.3	-16.0	15.6	-19.0	18.1	-22.0	20.8	-25.0	23.6	-29.0	26.7	-32.0	29.9	-36.8	
	3	100	10.9	-13.0	11.9	-14.0	12.9	-15.0	15.1	-18.0	17.6	-21.0	20.2	-24.0	22.9	-27.0	25.9	-31.0	29.0	-35.0	
	Wall	4	10	13.1	-14.0	14.3	-15.0	15.5	-16.0	18.2	-19.0	21.2	-22.0	24.3	-26.0	27.7	-30.0	31.2	-33.0	35.0	-37.9
		4	20	12.5	-13.0	13.6	-14.0	14.8	-16.0	17.4	-19.0	20.2	-22.0	23.2	-25.0	26.4	-28.0	29.7	-32.0	33.4	-36.4
		4	50	11.7	-12.0	12.8	-14.0	13.9	-15.0	16.3	-17.0	19.0	-20.0	21.7	-23.0	24.7	-27.0	27.9	-30.0	31.3	-34.3
4		100	11.1	-12.0	12.1	-13.0	13.2	-14.0	15.5	-17.0	18.0	-19.0	20.6	-22.0	23.5	-25.0	26.5	-29.0	29.8	-32.7	
4		500	10.0	-10.0	10.6	-11.0	11.6	-12.0	13.6	-15.0	15.8	-17.0	18.1	-20.0	20.6	-22.0	23.2	-25.0	26.1	-29.0	
5		10	13.1	-17.0	14.3	-19.0	15.5	-20.0	18.2	-24.0	21.2	-28.0	24.3	-32.0	27.7	-37.0	31.2	-41.0	35.0	-46.8	
5		20	12.5	-16.0	13.6	-17.0	14.8	-19.0	17.4	-22.0	20.2	-26.0	23.2	-30.0	26.4	-34.0	29.7	-39.0	33.4	-43.7	
5		50	11.7	-14.0	12.8	-16.0	13.9	-17.0	16.3	-20.0	19.0	-23.0	21.7	-27.0	24.7	-31.0	27.9	-35.0	31.3	-39.5	
5		100	11.1	-13.0	12.1	-14.0	13.2	-16.0	15.5	-19.0	18.0	-22.0	20.6	-25.0	23.5	-28.0	26.5	-32.0	29.8	-36.4	
5		500	10.0	-10.0	10.6	-11.0	11.6	-12.0	13.6	-15.0	15.8	-17.0	18.1	-20.0	20.6	-22.0	23.2	-25.0	26.1	-29.0	

For SI: 1 foot = 304.8 mm, 1 square foot = 0.0929 m², 1 mile per hour = 0.447 m/s, 1 pound per square foot = 0.0479 kPa.

- a. The effective wind area shall be equal to the span length multiplied by an effective width. This width shall be permitted to be not less than one-third the span length. For cladding fasteners, the effective wind area shall not be greater than the area that is tributary to an individual fastener.
- b. For effective areas between those given, the load shall be interpolated or the load associated with the lower effective area shall be used.
- c. Table values shall be adjusted for height and exposure by multiplying by the adjustment coefficient in Table R301.2(3).
- d. See Figure R301.2(8) for location of zones.
- e. Plus and minus signs signify pressures acting toward and away from the building surfaces.

**TABLE R301.2(3)
HEIGHT AND EXPOSURE ADJUSTMENT COEFFICIENTS FOR TABLE R301.2(2)**

MEAN ROOF HEIGHT	EXPOSURE		
	B	C	D
15	1.00	1.21	1.47
20	1.00	1.29	1.55
25	1.00	1.35	1.61
30	1.00	1.40	1.66
35	1.05	1.45	1.70
40	1.09	1.49	1.74
45	1.12	1.53	1.78
50	1.16	1.56	1.81
55	1.19	1.59	1.84
60	1.22	1.62	1.87

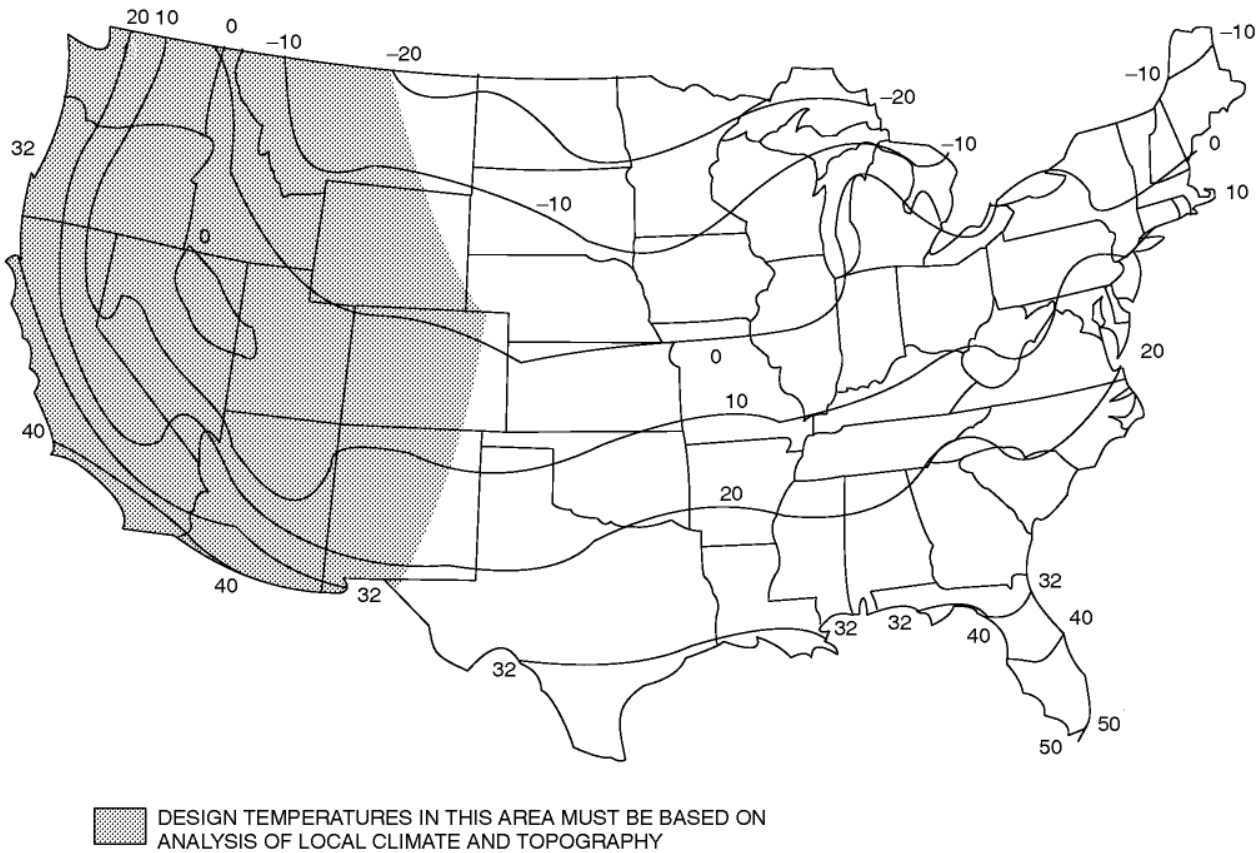

For SI: °C = [(°F)-32]/1.8.

**FIGURE R301.2(1)
ISOLINES OF THE 97-1/2 -PERCENT WINTER (DECEMBER, JANUARY AND FEBRUARY) DESIGN TEMPERATURES (°F)**

R301.2.1 Wind design criteria. Buildings and portions thereof shall be constructed in accordance with the wind provisions of this code using the ultimate design wind speed in Table R301.2(1) as determined from Figure R301.2(5)A. The structural provisions of this code for wind loads are not permitted where wind design is required as specified in Section R301.2.1.1. Where different construction methods and structural materials are used for various portions of a building, the applicable requirements of this section for each portion shall apply. Where not otherwise specified, the wind loads listed in Table R301.2(2) adjusted for height and exposure using Table R301.2(3) shall be used to determine design load performance requirements for wall coverings, curtain walls, roof coverings, exterior windows, skylights, garage doors and exterior doors. Asphalt shingles shall be

designed for wind speeds in accordance with Section R905.2.4. A continuous load path shall be provided to transmit the applicable uplift forces in Section R802.11.1 from the roof assembly to the foundation.

R301.2.1.1 Wind limitations and wind design required. The wind provisions of this code shall not apply to the design of buildings where wind design is required in accordance with Figure R301.2(5)B.

Exceptions:

1. For concrete construction, the wind provisions of this code shall apply in accordance with the limitations of Sections R404 and R608.
2. For structural insulated panels, the wind provisions of this code shall apply in accordance with the limitations of Section R610.
3. For cold-formed steel light-frame construction, the wind provisions of this code shall apply in accordance with the limitations of Sections R505, R603 and R804.

In regions where wind design is required in accordance with Figure R301.2(5)B, the design of buildings for wind loads shall be in accordance with one or more of the following methods:

1. AWC *Wood Frame Construction Manual* (WFCM).
2. ICC *Standard for Residential Construction in High-Wind Regions* (ICC 600).
3. ASCE *Minimum Design Loads for Buildings and Other Structures* (ASCE 7).
4. AISI *Standard for Cold-Formed Steel Framing—Prescriptive Method For One- and Two-Family Dwellings* (AISI S230).
5. *International Building Code*.

The elements of design not addressed by the methods in Items 1 through 5 shall be in accordance with the provisions of this code.

Where ASCE 7 or the *International Building Code* is used for the design of the building, the wind speed map and exposure category requirements as specified in ASCE 7 and the *International Building Code* shall be used.

R301.2.1.1.1 Sunrooms. *Sunrooms* shall comply with AAMA/NPEA/NSA 2100. For the purpose of applying the criteria of AAMA/NPEA/NSA 2100 based on the intended use, *sunrooms* shall be identified as one of the following categories by the permit applicant, design professional or the property owner or owner's agent in the construction documents. Component and cladding pressures shall be used for the design of elements that do not qualify as main windforce-resisting systems. Main windforce-resisting system pressures shall be used for the design of elements assigned to provide support and stability for the overall *sunroom*.

Category I: A thermally isolated *sunroom* with walls that are open or enclosed with insect screening or 0.5 mm (20 mil) maximum thickness plastic film. The space is nonhabitable and unconditioned.

Category II: A thermally isolated *sunroom* with enclosed walls. The openings are enclosed with translucent or transparent plastic or glass. The space is nonhabitable and unconditioned.

Category III: A thermally isolated *sunroom* with enclosed walls. The openings are enclosed with translucent or transparent plastic or glass. The sunroom fenestration complies with additional requirements for air infiltration resistance and water penetration resistance. The space is nonhabitable and unconditioned.

Category IV: A thermally isolated *sunroom* with enclosed walls. The sunroom is designed to be heated or cooled by a separate temperature control or system and is thermally isolated from the primary structure. The *sunroom* fenestration complies with additional requirements for water penetration resistance, air infiltration resistance and thermal performance. The space is nonhabitable and conditioned.

Category V: A *sunroom* with enclosed walls. The sunroom is designed to be heated or cooled and is open to the main structure. The *sunroom* fenestration complies with additional requirements for water penetration resistance, air infiltration resistance and thermal performance. The space is habitable and conditioned.

R301.2.1.2 Protection of openings. Exterior glazing in buildings located in windborne debris regions shall be protected from windborne debris. Glazed opening protection for windborne debris shall meet the requirements of the Large Missile Test of ASTM E1996 and ASTM E1886 as modified in Section 301.2.1.2.1. Garage door glazed opening protection for windborne debris shall meet the requirements of an *approved* impact-resisting standard or ANSI/DASMA 115.

Exception: Wood structural panels with a thickness of not less than 7/16 inch (11 mm) and a span of not more than 8 feet (2438 mm) shall be permitted for opening protection. Panels shall be precut and attached to the framing surrounding the opening containing the product with the glazed opening. Panels shall be predrilled as required for the anchorage method and shall be secured with the attachment hardware provided. Attachments shall be designed to resist the component and cladding loads determined in accordance with either Table R301.2(2) or ASCE 7, with the permanent corrosion-resistant attachment hardware provided and anchors permanently installed on the building. Attachment in

accordance with Table R301.2.1.2 is permitted for buildings with a *mean roof height* of 45 feet (13 728 mm) or less where the ultimate design wind speed, V_{ult} , is 180 mph (290 kph) or less.

R301.2.1.2.1 Application of ASTM E1996. The text of Section 2.2 of ASTM E1996 shall be substituted as follows:

2.2 ASCE Standard:

ASCE 7-10 American Society of Civil Engineers *Minimum Design Loads for Buildings and Other Structures*

The text of Section 6.2.2 of ASTM E1996 shall be substituted as follows:

6.2.2 Unless otherwise specified, select the wind zone based on the ultimate design wind speed, V_{ult} , as follows:

6.2.2.1 Wind Zone 1—130 mph \leq ultimate design wind speed, $V_{ult} < 140$ mph.

6.2.2.2 Wind Zone 2—140 mph \leq ultimate design wind speed, $V_{ult} < 150$ mph at greater than 1 mile (1.6 km) from the coastline. The coastline shall be measured from the mean high-water mark.

6.2.2.3 Wind Zone 3—150 mph (58 m/s) \leq ultimate design wind speed, $V_{ult} \leq 170$ mph (76 m/s), or 140 mph (54 m/s) \leq ultimate design wind speed, $V_{ult} \leq 170$ mph (76 m/s) and within 1 mile (1.6 km) of the coastline. The coastline shall be measured from the mean high-water mark.

6.2.2.4 Wind Zone 4—ultimate design wind speed, $V_{ult} > 170$ mph (76 m/s).

TABLE R301.2.1.2
WINDBORNE DEBRIS PROTECTION FASTENING SCHEDULE FOR WOOD STRUCTURAL PANELS^{a, b, c, d}

FASTENER TYPE	FASTENER SPACING (inches) ^{a, b}		
	Panel span \leq 4 feet	4 feet $<$ panel span \leq 6 feet	6 feet $<$ panel span \leq 8 feet
No. 8 wood-screw-based anchor with 2-inch embedment length	16	10	8
No. 10 wood-screw-based anchor with 2-inch embedment length	16	12	9
1/4-inch lag-screw-based anchor with 2-inch embedment length	16	16	16

For SI: 1 inch = 25.4 mm, 1 foot = 304.8 mm, 1 pound = 4.448 N,
1 mile per hour = 0.447 m/s.

- a. This table is based on 180 mph ultimate design wind speeds, V_{ult} , and a 45-foot mean roof height.
- b. Fasteners shall be installed at opposing ends of the wood structural panel. Fasteners shall be located not less than 1 inch from the edge of the panel.
- c. Anchors shall penetrate through the exterior wall covering with an embedment length of not less than 2 inches into the building frame. Fasteners shall be located not less than 2-1/2 inches from the edge of concrete block or concrete.
- d. Panels attached to masonry or masonry/stucco shall be attached using vibration-resistant anchors having an ultimate withdrawal capacity of not less than 1,500 pounds.

R301.2.1.3 Wind speed conversion. Where referenced documents are based on nominal design wind speeds and do not provide the means for conversion between ultimate design wind speeds and nominal design wind speeds, the ultimate design wind speeds, V_{ult} , of Figure R301.2(5)A shall be converted to nominal design wind speeds, V_{asd} , using Table R301.2.1.3.

TABLE R301.2.1.3
WIND SPEED CONVERSIONS^a

V_{ult}	110	115	120	130	140	150	160	170	180	190	200
V_{asd}	85	89	93	101	108	116	124	132	139	147	155

For SI: 1 mile per hour = 0.447 m/s.

- a. Linear interpolation is permitted.

R301.2.1.4 Exposure category. For each wind direction considered, an exposure category that adequately reflects the characteristics of ground surface irregularities shall be determined for the site at which the building or structure is to be constructed. For a site located in the transition zone between categories, the category resulting in the largest wind forces shall apply. Account shall be taken of variations in ground surface roughness that arise from natural topography and vegetation as well as from constructed features. For a site where multiple detached one- and two-family *dwelling*s, *townhouses* or other structures are to be constructed as part of a subdivision or master-planned community, or are otherwise designated as a developed area by the authority having jurisdiction, the exposure category for an individual structure shall be based on the site conditions that will exist at the time when all adjacent structures on the site have been constructed, provided that their construction is expected to begin within 1 year of the start of construction for the structure for which the exposure category is determined. For any given wind direction, the exposure in which a specific building or other structure is sited shall be assessed as being one of the following categories:

- ~~(1. Exposure B. Urban and suburban areas, wooded areas or other terrain with numerous closely spaced obstructions having the size of single family *dwelling*s or larger. Exposure B shall be assumed unless the site meets the definition of another type exposure.~~
- 2. Exposure C. Open terrain with scattered obstructions, including surface undulations or other irregularities, having heights generally less than 30 feet (9144 mm) extending more than 1,500 feet (457 m) from the building site in any

quadrant. This exposure shall apply to any building located within Exposure B type terrain where the building is directly adjacent to open areas of Exposure C type terrain in any quadrant for a distance of more than 600 feet (183 m). This category includes flat, open country and grasslands.

3. Exposure D. Flat, unobstructed areas exposed to wind flowing over open water, smooth mud flats, salt flats and unbroken ice for a distance of not less than 5,000 feet (1524 m). This exposure shall apply only to those buildings and other structures exposed to the wind coming from over the unobstructed area. Exposure D extends downwind from the edge of the unobstructed area a distance of 600 feet (183 m) or 20 times the height of the building or structure, whichever is greater.)
1. Exposure B. Exposure B shall apply for all cases where Exposure C does not apply.
2. Exposure C. Exposure C shall apply along the shorelines where the ground surface roughness, as defined by Surface Roughness D, prevails in the following conditions:
 1. The upwind direction of the shoreline is exposed to winds coming from the south through west (180 degrees to 270 degrees); and
 2. The distance of Surface Roughness D is at least 5,000 feet (1524 m).

Exposure C extends a distance of 600 feet (183 m) from the shoreline as defined in the previous sentence.
3. Exposure D. Exposure D shall not apply anywhere within the City of Seattle.

Interpretation IR301.2.1.4: A map of the Exposure C areas is provided at <https://www.seattle.gov/sdci/resources/wind-load-factors>.

R301.2.1.5 Topographic wind effects. In areas designated in Table R301.2(1) as having local historical data documenting structural damage to buildings caused by wind speed-up at isolated hills, ridges and escarpments that are abrupt changes from the general topography of the area, topographic wind effects shall be considered in the design of the building in accordance with Section R301.2.1.5.1 or in accordance with the provisions of ASCE 7. See Figure R301.2.1.5.1(1) for topographic features for wind speed-up effect.

In these designated areas, topographic wind effects shall apply only to buildings sited on the top half of an isolated hill, ridge or escarpment where all of the following conditions exist:

1. The average slope of the top half of the hill, ridge or escarpment is 10 percent or greater.
2. The hill, ridge or escarpment is 60 feet (18 288 mm) or greater in height for Exposure B, 30 feet (9144 mm) or greater in height for Exposure C, and 15 feet (4572 mm) or greater in height for Exposure D.
3. The hill, ridge or escarpment is isolated or unobstructed by other topographic features of similar height in the upwind direction for a distance measured from its high point of 100 times its height or 2 miles (3.2 km), whichever is less. See Figure R301.2.1.5.1(3) for upwind obstruction.
4. The hill, ridge or escarpment protrudes by a factor of two or more above the height of other upwind topographic features located in any quadrant within a radius of 2 miles (3.2 km) measured from its high point.

R301.2.1.5.1 Simplified topographic wind speed-up method. As an alternative to the ASCE 7 topographic wind provisions, the provisions of Section R301.2.1.5.1 shall be permitted to be used to design for wind speed-up effects, where required by Section R301.2.1.5.

Structures located on the top half of isolated hills, ridges or escarpments meeting the conditions of Section R301.2.1.5 shall be designed for an increased basic wind speed as determined by Table R301.2.1.5.1. On the high side of an escarpment, the increased basic wind speed shall extend horizontally downwind from the edge of the escarpment 1.5 times the horizontal length of the upwind slope (1.5L) or 6 times the height of the escarpment (6H), whichever is greater. See Figure R301.2.1.5.1(2) for where wind speed increase is applied.

Code Alternate CA301.2.1.5.1:
Topographic Factor Maps. As an alternative to the requirements in R301.2.1.5.1 structures shall be permitted to be designed for an increased basic wind speed as determined by the following equation:

$$V = V_{ult} \sqrt{K_{zt}}$$

K_{zt} , the topographic factor, shall be permitted to be obtained from ASCE 7 or rules promulgated by the building official.

Interpretation CA301.2.1.5.1: As an alternative to obtaining the topographic factor K_{zt} from ASCE 7, it shall be permitted to obtain the default topographic factors from the Wind Load Factors map provided at <https://www.seattle.gov/sdci/resources/wind-load-factors>.

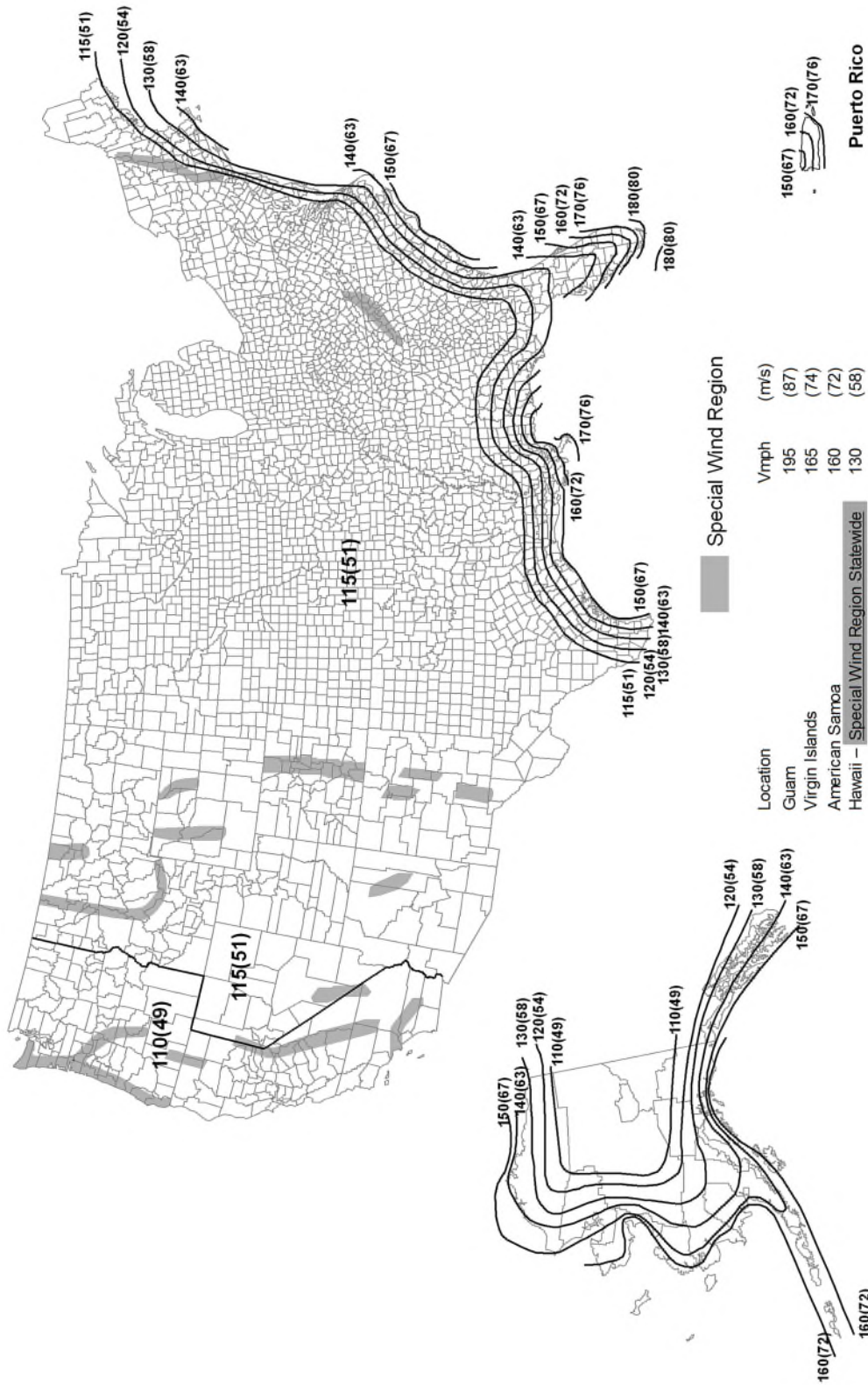

- Notes:
1. Values are nominal design 3-second gust wind speeds in miles per hour (m/s) at 33 ft (10m) above ground for Exposure C category.
 2. Linear interpolation between contours is permitted.
 3. Islands and coastal areas outside the last contour shall use the last wind speed contour of the coastal area.
 4. Mountainous terrain, gorges, ocean promontories, and special wind regions shall be examined for unusual wind conditions.
 5. Wind speeds correspond to approximately a 7% probability of exceedance in 50 years (Annual Exceedance Probability = 0.00143, MRI = 700 Years).

FIGURE R301.2(5)A
ULTIMATE DESIGN WIND SPEEDS

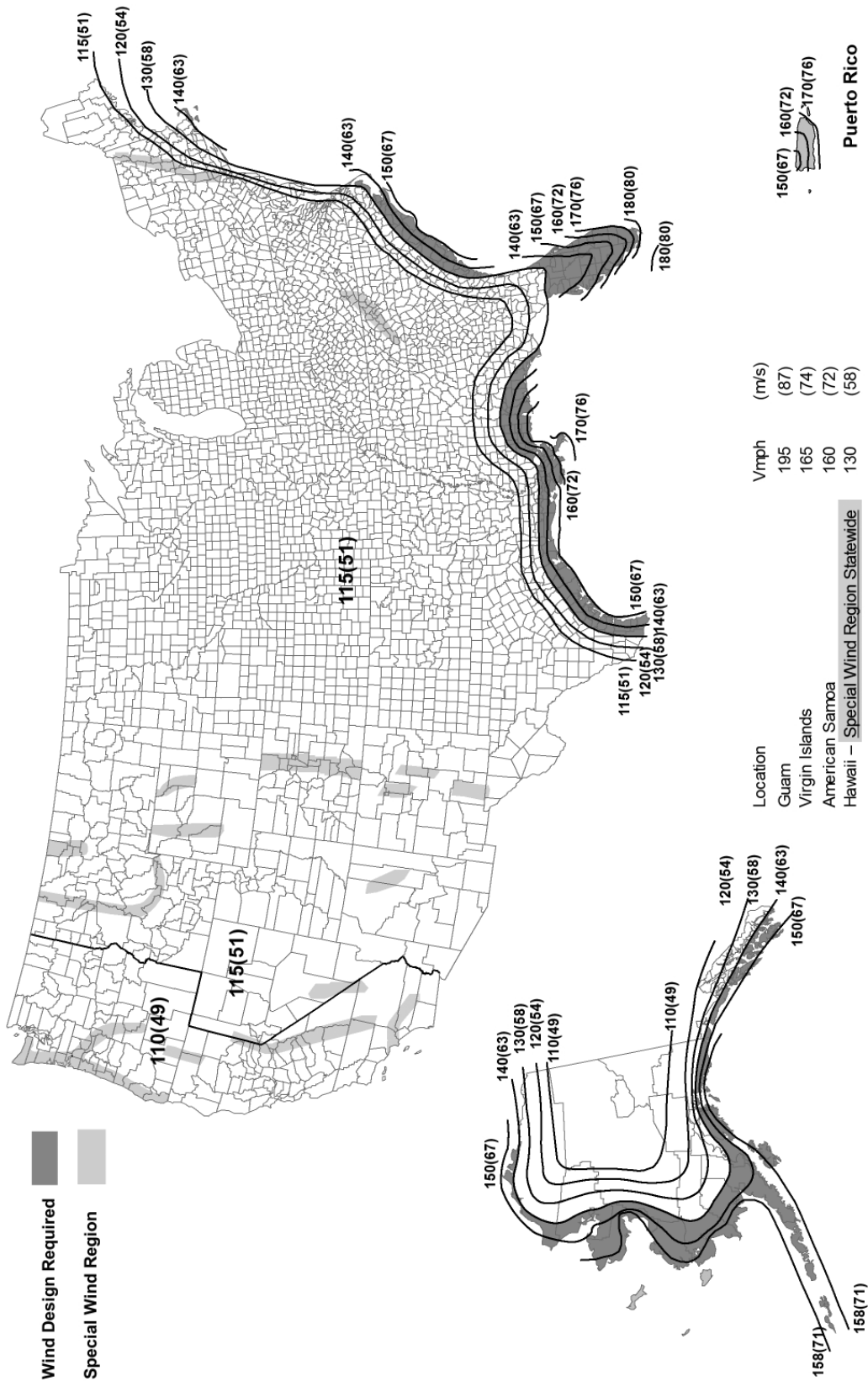

Notes:

1. Values are nominal design 3-second gust wind speeds in miles per hour (m/s) at 33 ft (10m) above ground for Exposure C category.
2. Linear interpolation between contours is permitted.
3. Islands and coastal areas outside the last contour shall use the last wind speed contour of the coastal area.
4. Mountainous terrain, gorges, ocean promontories, and special wind regions shall be examined for unusual wind conditions.
5. Wind speeds correspond to approximately a 7% probability of exceedance in 50 years (Annual Exceedance Probability = 0.00143, MRI = 700 Years).

FIGURE R301.2(5)B
REGIONS WHERE WIND DESIGN IS REQUIRED

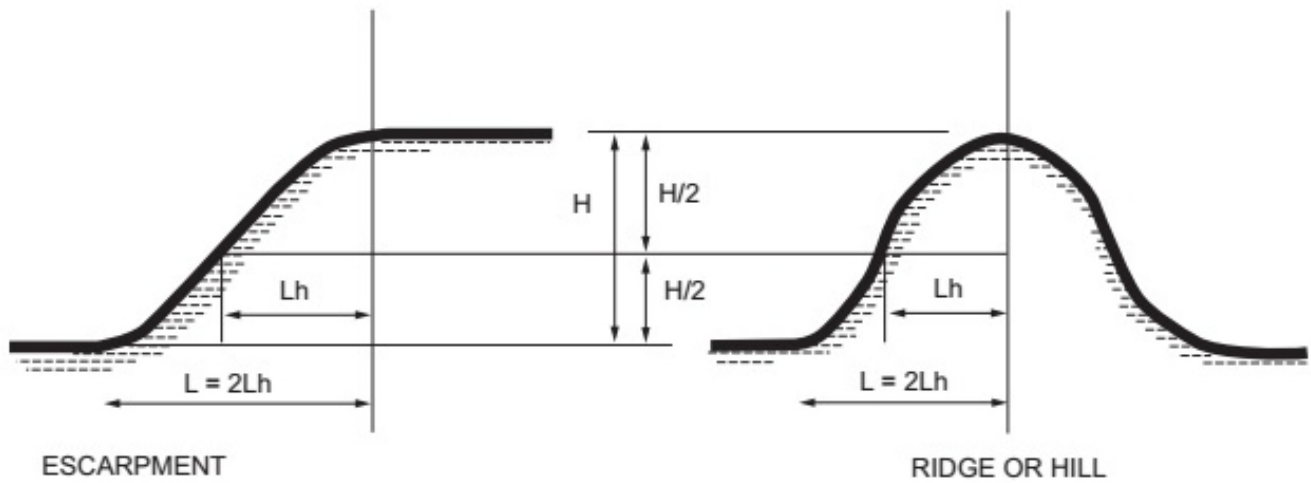

Note: $H/2$ determines the measurement point for L_h . L is twice L_h .

FIGURE R301.2.1.5.1(1)
TOPOGRAPHIC FEATURES FOR WIND SPEED-UP EFFECT

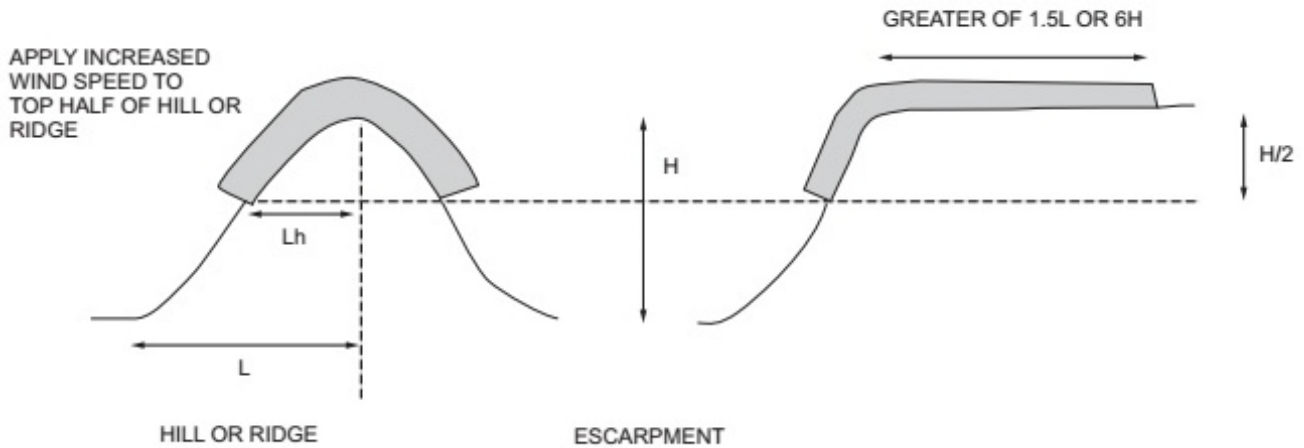

FIGURE R301.2.1.5.1(2)
ILLUSTRATION OF WHERE ON A TOPOGRAPHIC FEATURE, WIND SPEED INCREASE IS APPLIED

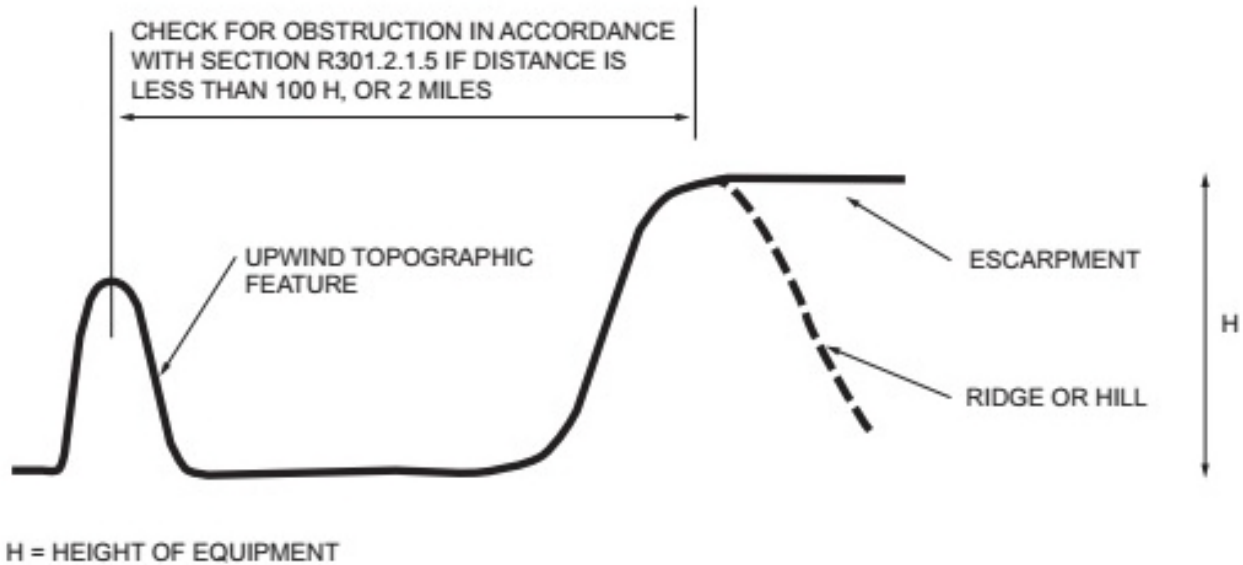

FIGURE R301.2.1.5.1(3)
UPWIND OBSTRUCTION

TABLE R301.2.1.5.1
ULTIMATE DESIGN WIND SPEED MODIFICATION FOR TOPOGRAPHIC WIND EFFECT^{a, b}

ULTIMATE DESIGN WIND SPEED FROM FIGURE R301.2(5)A (mph)	AVERAGE SLOPE OF THE TOP HALF OF HILL, RIDGE OR ESCARPMENT (percent)						
	0.10	0.125	0.15	0.175	0.20	0.23	0.25
	Required ultimate design wind ((speed-up) speed, modified for topographic wind speed-up (mph))						
110	132	137	142	147	152	158	162
115	138	143	148	154	159	165	169
120	144	149	155	160	166	172	176
130	156	162	168	174	179	NA	NA
140	168	174	181	NA	NA	NA	NA
150	180	NA	NA	NA	NA	NA	NA

For SI: 1 mile per hour = 0.447 m/s, 1 foot = 304.8 mm.

NA = Not Applicable.

- a. Table applies to a feature height of 500 feet or less and dwellings sited a distance equal or greater than half the feature height.
- b. Where the ultimate design wind speed as modified by Table R301.2.1.5.1 equals or exceeds 140 miles per hour, the building shall be considered as “wind design required” in accordance with Section R301.2.1.1.

R301.2.2 Seismic provisions. Buildings in Seismic Design Categories C, D₀, D₁, and D₂ shall be constructed in accordance with the requirements of this section and other seismic requirements of this code. The seismic provisions of this code shall apply as follows:

1. *Townhouses* in Seismic Design Categories C, D₀, D₁ and D₂.
2. Detached one- and two-family *dwellings* in Seismic Design Categories, D₀, D₁ and D₂.

Buildings in Seismic Design Category E shall be designed to resist seismic loads in accordance with the *International Building Code*, except where the seismic design category is reclassified to a lower seismic design category in accordance with Section R301.2.2.1. Components of buildings not required to be designed to resist seismic loads shall be constructed in accordance with the provisions of this code.

R301.2.2.1 Determination of seismic design category. Buildings shall be assigned a seismic design category in accordance with Figure R301.2(2).

R301.2.2.1.1 Alternate determination of seismic design category. The seismic design categories and corresponding short-period design spectral response accelerations, S_{DS} , shown in Figure R301.2(2), are based on soil Site Class D, used as an assumed default, as defined in Section 1613.2.2 of the *International Building Code*. If soil conditions are deter-

mined by the building official to be Site Class A, B, or D, the seismic design category and short-period design spectral response accelerations, S_{DS} , for a site shall be allowed to be determined in accordance with Figure R301.2(3), or Section 1613.2 of the *International Building Code*. The value of S_{DS} determined in accordance with Section 1613.2 of the *International Building Code* is permitted to be used to set the seismic design category in accordance with Table R301.2.2.1.1, and to interpolate between values in Tables R602.10.3(3), R603.9.2(1) and other seismic design requirements of this code.

**TABLE R301.2.2.1.1
SEISMIC DESIGN CATEGORY DETERMINATION**

CALCULATED S_{DS}	SEISMIC DESIGN CATEGORY
$S_{DS} \leq 0.17g$	A
$0.17g < S_{DS} \leq 0.33g$	B
$0.33g < S_{DS} \leq 0.50g$	C
$0.50g < S_{DS} \leq 0.67g$	D ₀
$0.67g < S_{DS} \leq 0.83g$	D ₁
$0.83g < S_{DS} \leq 1.25g$	D ₂
$1.25g < S_{DS}$	E

R301.2.2.1.2 Alternative determination of Seismic Design Category E. Buildings located in Seismic Design Category E in accordance with Figure R301.2(2), or Figure R301.2(3) where applicable, are permitted to be reclassified as being in Seismic Design Category D₂ provided that one of the following is done:

1. A more detailed evaluation of the seismic design category is made in accordance with the provisions and maps of the *International Building Code*. Buildings located in Seismic Design Category E in accordance with Table R301.2.2.1.1, but located in Seismic Design Category D in accordance with the *International Building Code*, shall be permitted to be designed using the Seismic Design Category D₂ requirements of this code.
2. Buildings located in Seismic Design Category E that conform to the following additional restrictions are permitted to be constructed in accordance with the provisions for Seismic Design Category D₂ of this code:
 - 2.1. All exterior shear wall lines or *braced wall panels* are in one plane vertically from the foundation to the uppermost story.
 - 2.2. Floors shall not cantilever past the *exterior walls*.
 - 2.3. The building is within the requirements of Section R301.2.2.2.6 for being considered as regular.

R301.2.2.2 Weights of materials. Average dead loads shall not exceed 15 pounds per square foot (720 Pa) for the combined roof and ceiling assemblies (on a horizontal projection) or 10 pounds per square foot (480 Pa) for floor assemblies, except as further limited by Section R301.2.2. Dead loads for walls above *grade* shall not exceed:

1. Fifteen pounds per square foot (720 Pa) for exterior light-frame wood walls.
2. Fourteen pounds per square foot (670 Pa) for exterior light-frame cold-formed steel walls.
3. Ten pounds per square foot (480 Pa) for interior light-frame wood walls.
4. Five pounds per square foot (240 Pa) for interior light-frame cold-formed steel walls.
5. Eighty pounds per square foot (3830 Pa) for 8-inch-thick (203 mm) masonry walls.
6. Eighty-five pounds per square foot (4070 Pa) for 6-inch-thick (152 mm) concrete walls.
7. Ten pounds per square foot (480 Pa) for SIP walls.

Exceptions:

1. Roof and ceiling dead loads not exceeding 25 pounds per square foot (1190 Pa) shall be permitted provided that the wall bracing amounts in Section R602.10.3 are increased in accordance with Table R602.10.3(4).
2. Light-frame walls with stone or masonry veneer shall be permitted in accordance with the provisions of Sections R702.1 and R703.
3. Fireplaces and chimneys shall be permitted in accordance with Chapter 10.

R301.2.2.3 Stone and masonry veneer. Anchored stone and masonry veneer shall comply with the requirements of Sections R702.1 and R703.

R301.2.2.4 Masonry construction. Masonry construction in Seismic Design Categories D_0 and D_1 shall comply with the requirements of Section R606.12.1. Masonry construction in Seismic Design Category D_2 shall comply with the requirements of Section R606.12.4.

R301.2.2.5 Concrete construction. Buildings with exterior above-grade concrete walls shall comply with PCA 100 or shall be designed in accordance with ACI 318.

Exception: Detached one- and two-family dwellings in Seismic Design Category C with exterior above-grade concrete walls are allowed to comply with the requirements of Section R608.

R301.2.2.6 Irregular buildings. The seismic provisions of this code shall not be used for structures, or portions thereof, located in Seismic Design Categories C, D_0 , D_1 and D_2 and considered to be irregular in accordance with this section. A building or portion of a building shall be considered to be irregular where one or more of the conditions defined in Items 1 through 7 occur. Irregular structures, or irregular portions of structures, shall be designed in accordance with accepted engineering practice to the extent the irregular features affect the performance of the remaining structural system. Where the forces associated with the irregularity are resisted by a structural system designed in accordance with accepted engineering practice, the remainder of the building shall be permitted to be designed using the provisions of this code.

1. **Shear wall or braced wall offsets out of plane.** Conditions where exterior shear wall lines or *braced wall panels* are not in one plane vertically from the foundation to the uppermost story in which they are required.

Exception: For wood light-frame construction, floors with cantilevers or setbacks not exceeding four times the nominal depth of the wood floor joists are permitted to support *braced wall panels* that are out of plane with *braced wall panels* below provided that all of the following are satisfied:

1. Floor joists are nominal 2 inches by 10 inches (51 mm by 254 mm) or larger and spaced not more than 16 inches (406 mm) on center.
2. The ratio of the back span to the cantilever is not less than 2 to 1.
3. Floor joists at ends of *braced wall panels* are doubled.
4. For wood-frame construction, a continuous rim joist is connected to ends of cantilever joists. Where spliced, the rim joists shall be spliced using a galvanized metal tie not less than 0.058 inch (1.5 mm) (16 gage) and 1-1/2 inches (38 mm) wide fastened with six 16d nails on each side of the splice; or a block of the same size as the rim joist and of sufficient length to fit securely between the joist space at which the splice occurs, fastened with eight 16d nails on each side of the splice.
5. Gravity loads carried at the end of cantilevered joists are limited to uniform wall and roof loads and the reactions from headers having a span of 8 feet (2438 mm) or less.

2. **Lateral support of roofs and floors.** Conditions where a section of floor or roof is not laterally supported by shear walls or *braced wall lines* on all edges.

Exception: Portions of floors that do not support shear walls, braced wall panels above, or roofs shall be permitted to extend not more than 6 feet (1829 mm) beyond a shear wall or *braced wall line*.

3. **Shear wall or braced wall offsets in plane.** Conditions where the end of a *braced wall panel* occurs over an opening in the wall below and extends more than 1 foot (305 mm) horizontally past the edge of the opening. This provision is applicable to shear walls and braced wall panels offset in plane and to braced wall panels offset out of plane in accordance with the exception to Item 1.

Exception: For wood light-frame wall construction, one end of a *braced wall panel* shall be permitted to extend more than 1 foot (305 mm) over an opening not more than 8 feet (2438 mm) in width in the wall below provided that the opening includes a header in accordance with all of the following:

1. The building width, loading condition and framing member species limitations of Table R602.7(1) shall apply.
2. The header is composed of:
 - 2.1. Not less than one 2×12 or two 2×10 for an opening not more than 4 feet (1219 mm) wide.
 - 2.2. Not less than two 2×12 or three 2×10 for an opening not more than 6 feet (1829 mm) in width.
 - 2.3. Not less than three 2×12 or four 2×10 for an opening not more than 8 feet (2438 mm) in width.
3. The entire length of the *braced wall panel* does not occur over an opening in the wall below.

4. **Floor and roof opening.** Conditions where an opening in a floor or roof exceeds the lesser of 12 feet (3658 mm) or 50 percent of the least floor or roof dimension.

5. **Floor level offset.** Conditions where portions of a floor level are vertically offset.

Exceptions:

1. Framing supported directly by continuous foundations at the perimeter of the building.

2. For wood light-frame construction, floors shall be permitted to be vertically offset where the floor framing is lapped or tied together as required by Section R502.6.1.

6. **Perpendicular shear wall and wall bracing.** Conditions where shear walls and *braced wall lines* do not occur in two perpendicular directions.

7. **Wall bracing in stories containing masonry or concrete construction.** Conditions where stories above *grade plane* are partially or completely braced by wood wall framing in accordance with Section R602 or cold-formed steel wall framing in accordance with Section R603 include masonry or concrete construction. Where this irregularity applies, the entire story shall be designed in accordance with accepted engineering practice.

Exceptions: Fireplaces, chimneys and masonry veneer in accordance with this code.

R301.2.2.7 Height limitations. Wood-framed buildings shall be limited to three stories above *grade plane* or the limits given in Table R602.10.3(3). Cold-formed steel-framed buildings shall be limited to less than or equal to three stories above *grade plane* in accordance with AISI S230. Mezzanines as defined in Section R202 that comply with Section R325 shall not be considered as stories. Structural insulated panel buildings shall be limited to two stories above *grade plane*.

R301.2.2.8 Cold-formed steel framing in Seismic Design Categories D₀, D₁ and D₂. In Seismic Design Categories D₀, D₁ and D₂ in addition to the requirements of this code, cold-formed steel framing shall comply with the requirements of AISI S230.

R301.2.2.9 Masonry chimneys. In Seismic Design Categories D₀, D₁ and D₂, masonry chimneys shall be reinforced and anchored to the building in accordance with Sections R1003.3 and R1003.4.

R301.2.2.10 Anchorage of water heaters. In Seismic Design Categories D₀, D₁ and D₂, water heaters shall be anchored against movement and overturning in accordance with Section M1307.2.

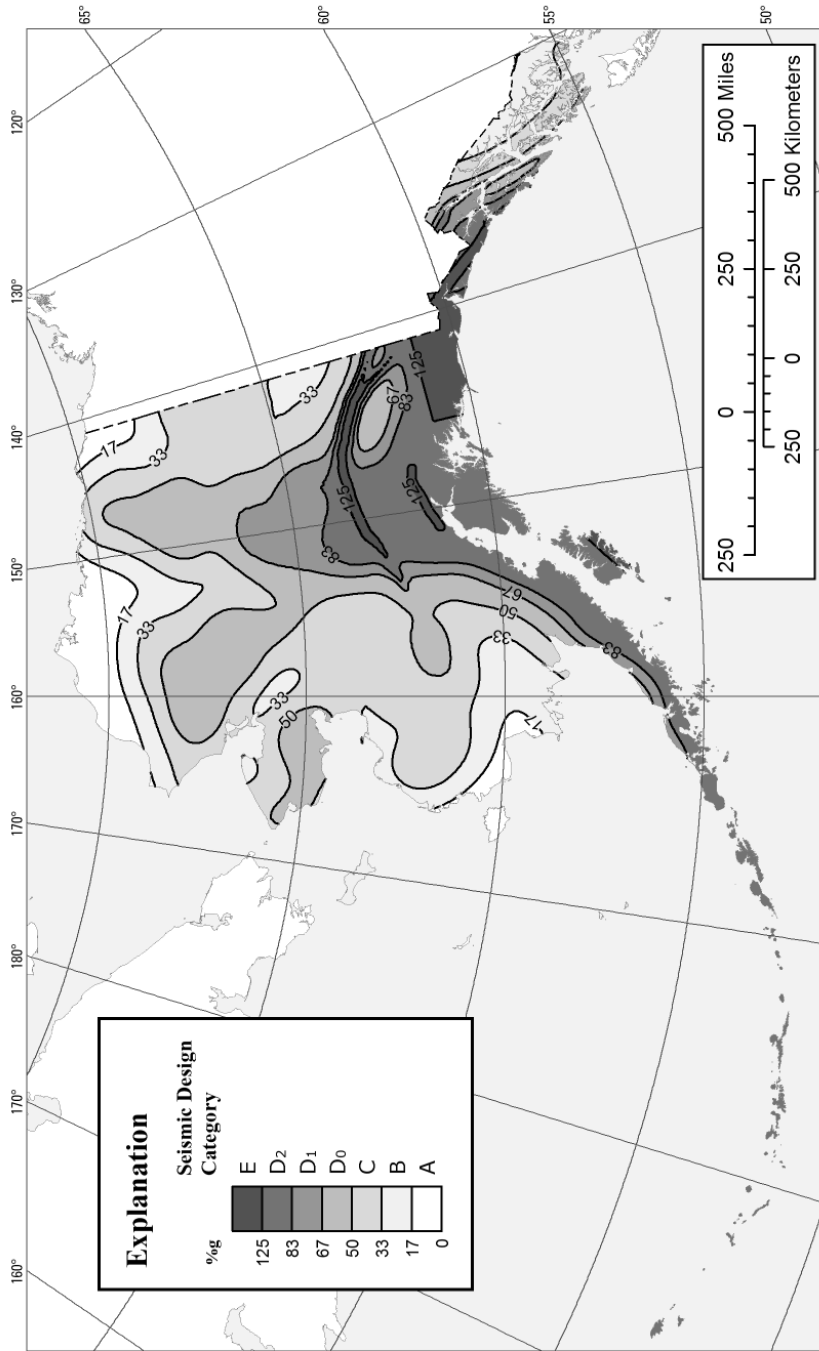

REFERENCES

Building Seismic Safety Council, 2015. NEHRP Recommended Seismic Provisions for New Buildings and Other Structures, FEMA P-1050. Federal Emergency Management Agency, Washington, DC.

Huang, Yin-Nan, Whitaker, A.S., and Luco, Nicolas, 2008. Maximum spectral demands in the near-fault region. Earthquake Spectra Volume 24, Issue 1, pp. 319-341.

Luco, Nicolas, Ellingwood, B.R., Hamburger, R.O., Hooper, J.D., Kimball, J.K., and Kircher, C.A., 2007. Risk-Targeted versus Current Seismic Design Maps for the Conterminous United States. Structural Engineers Association of California 2007 Convention Proceedings, pp. 163-175.

Wesson, Robert L., Boyd, Oliver S., Mueller, Charles S., Bluf, Charles G., Frankel, Arthur D., and Anderson, J., 2007. Assessment of future major probabilistic seismic hazard maps for Alaska: U.S. Geological Survey Open-File Report 2007-1043.

**FIGURE R301.2(2)
SEISMIC DESIGN CATEGORIES**

(continued)

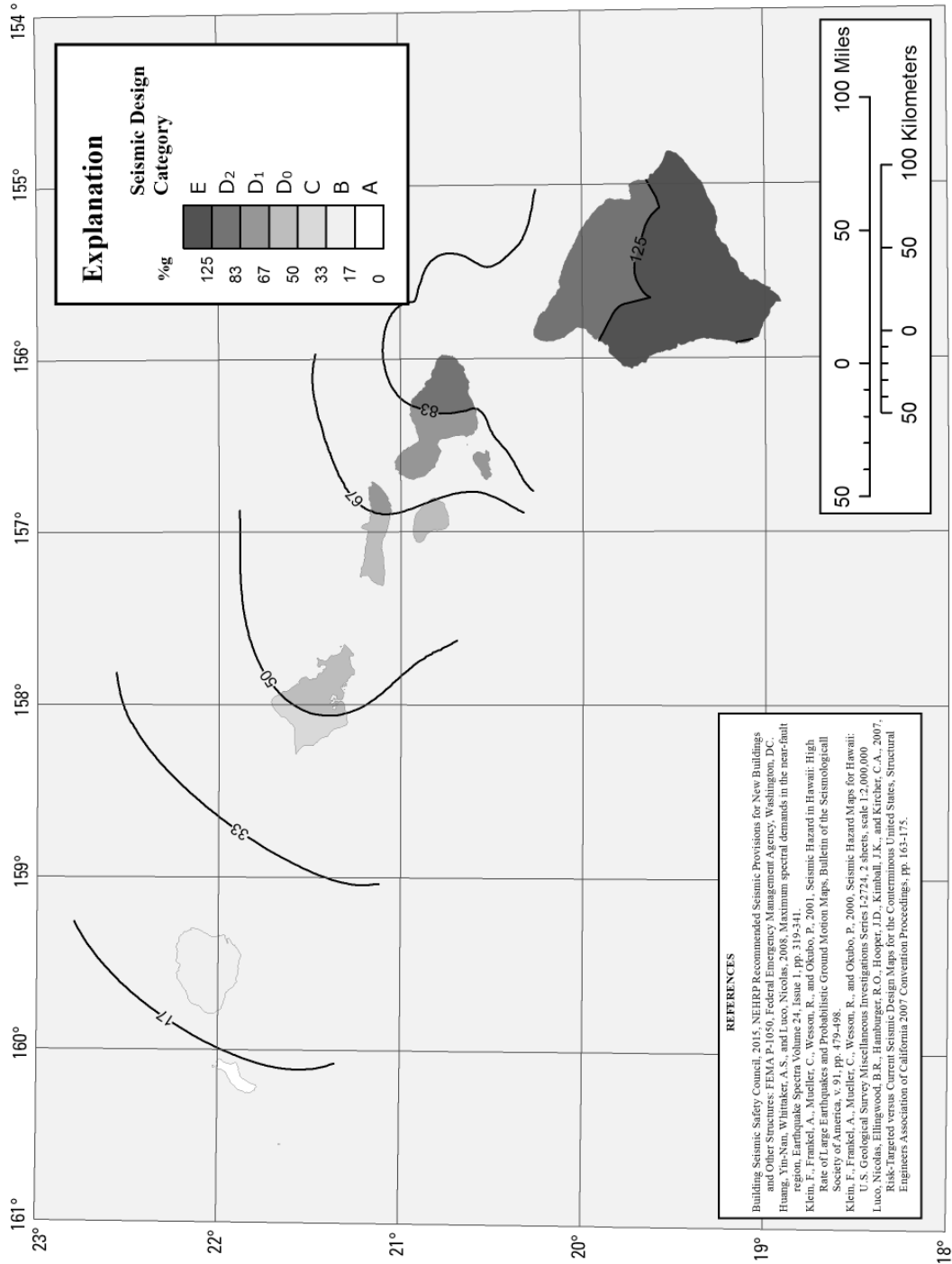
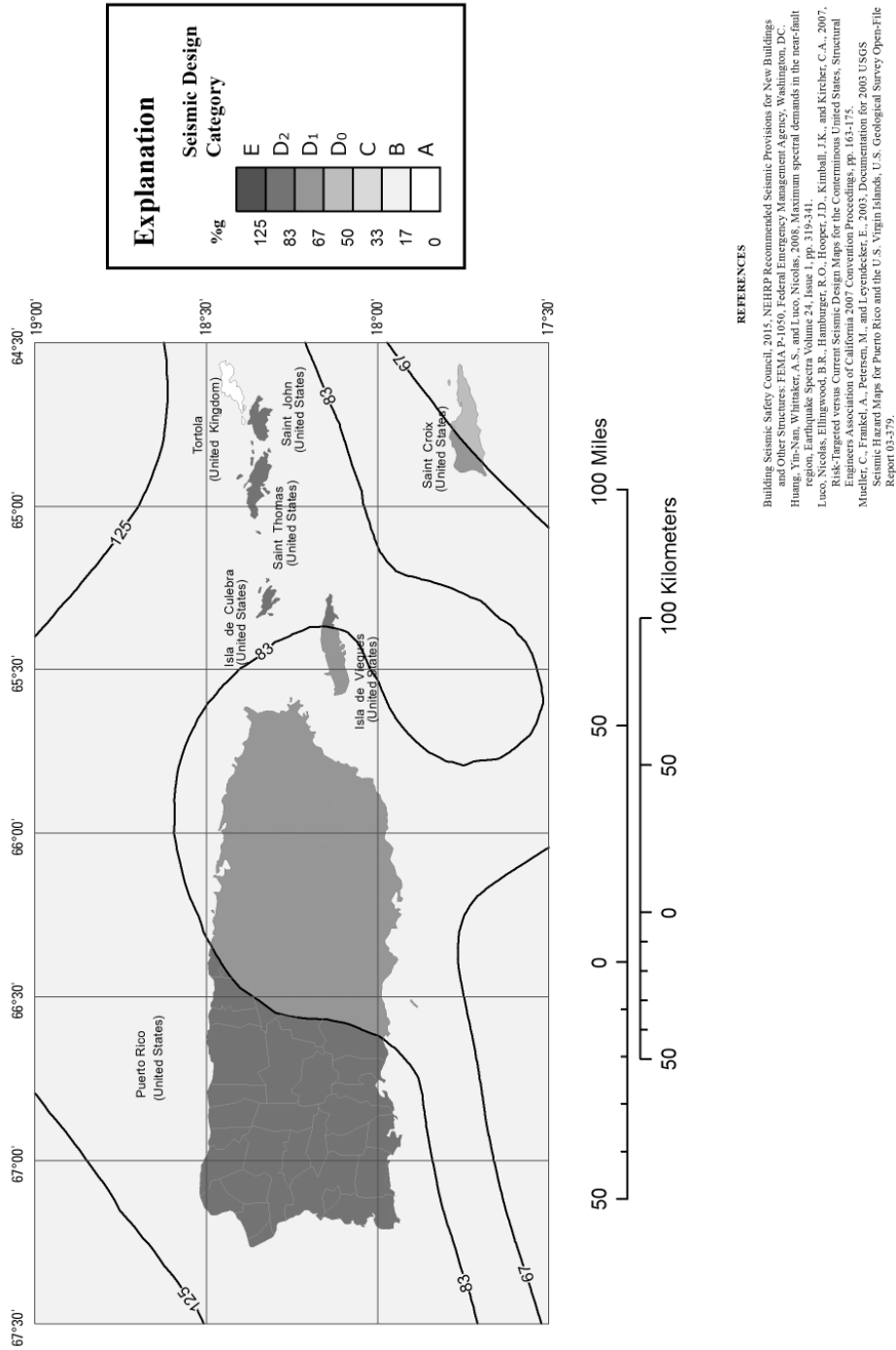

FIGURE R301.2(2)—continued
SEISMIC DESIGN CATEGORIES

(continued)



REFERENCES

Building Seismic Safety Council, 2015. NEHRP Recommended Seismic Provisions for New Buildings and Other Structures: FEMA P-1050, Federal Emergency Management Agency, Washington, DC.

Huang, Yin-Nan, Whitaker, A.S., and Luco, Nicolas, 2008. Maximum spectral demands in the near-fault region. Earthquake Spectra Volume 24, Issue 1, pp. 319-341.

Luco, Nicolas, Ellingwood, B.R., Hamburger, R.O., Hooper, J.D., Kimball, J.K., and Krieger, C.A., 2007. Risk-targeted versus Current Seismic Design Maps for the Conterminous United States, Structural Engineers Association of California, Computer Proceedings, pp. 163-174.

Mutler, C. F., and Peterson, M. J., 2003. Seismic Hazard Maps for 2003 USGS Seismic Hazard Maps for Puerto Rico and the U.S. Virgin Islands, U.S. Geological Survey Open-File Report 03-379.

Map prepared by U.S. Geological Survey in collaboration with the Federal Emergency Management Agency (FEMA)-funded Building Seismic Safety Council's (BSSC) Code Resource Support Committee (CRSC).

FIGURE R301.2(2)—continued
SEISMIC DESIGN CATEGORIES

(continued)

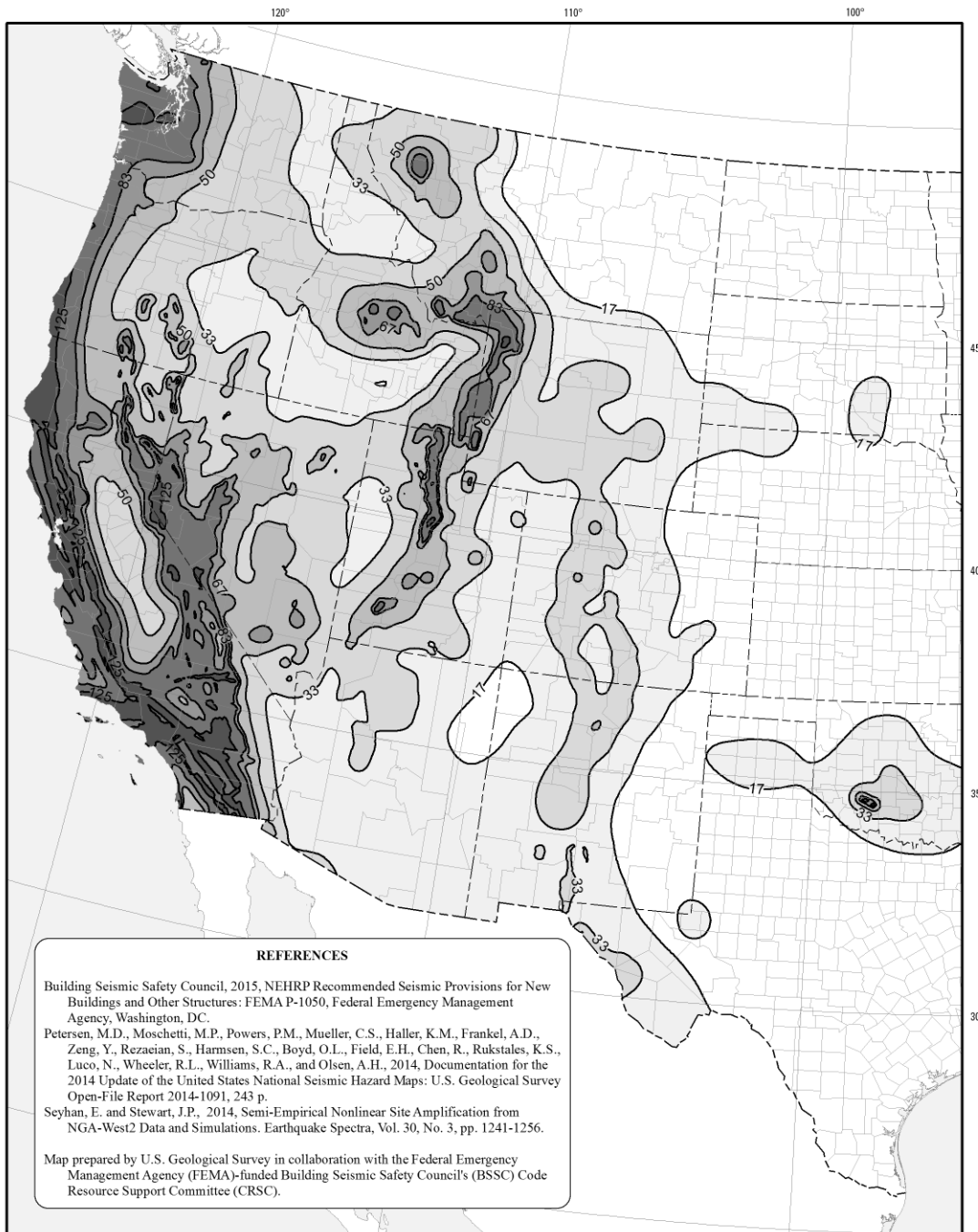

**FIGURE R301.2(2)—continued
SEISMIC DESIGN CATEGORIES**

(continued)

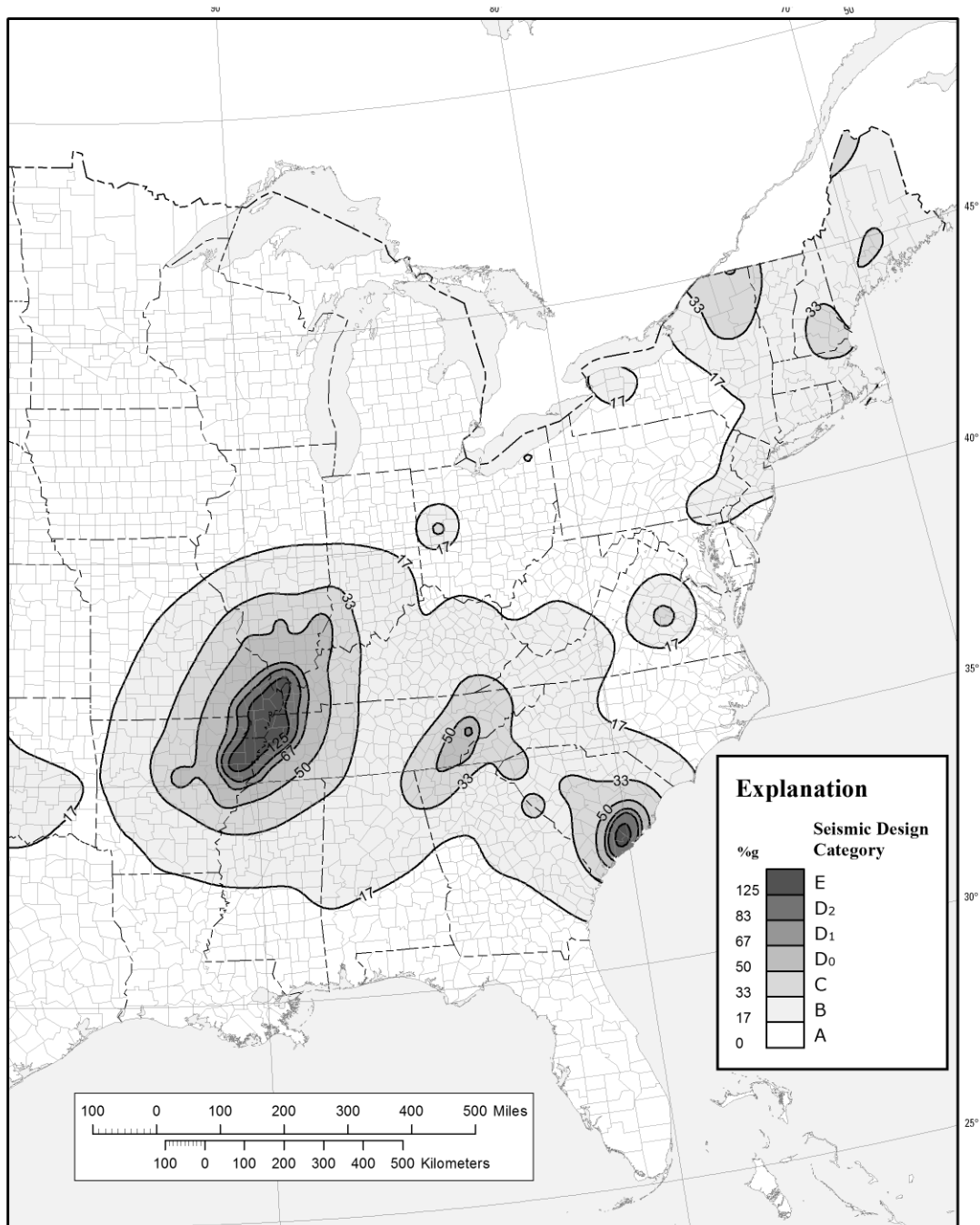

FIGURE R301.2(2)—continued
SEISMIC DESIGN CATEGORIES

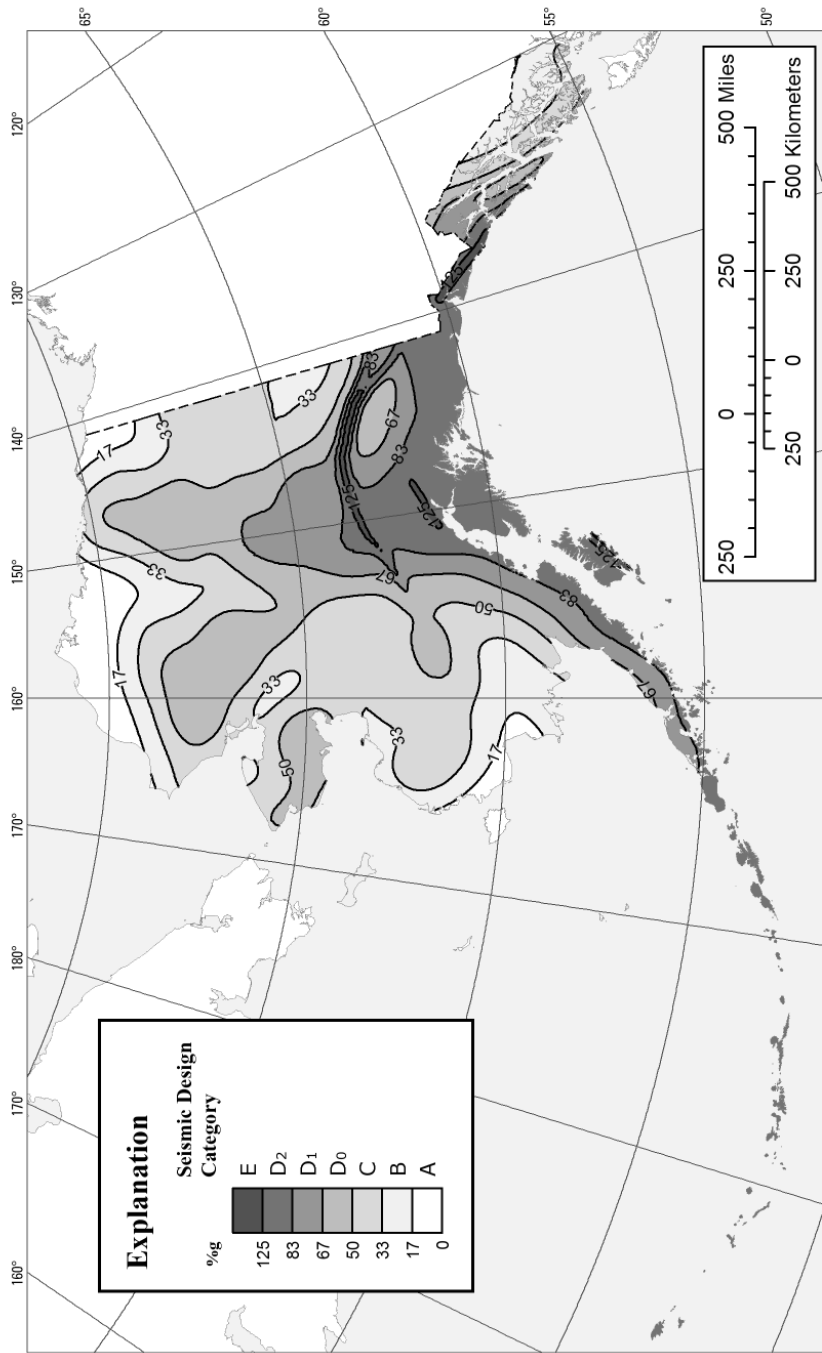

FIGURE R301.2(3)
ALTERNATE SEISMIC DESIGN CATEGORIES
(continued)

REFERENCES

Building Seismic Safety Council, 2015, NEHRP Recommended Seismic Provisions for New Buildings and Other Structures: FEMA P-1050, Federal Emergency Management Agency, Washington, DC.

Huang, Yin-Nan, Whitaker, A.S., and Luco, Nicolas, 2008, Maximum spectral demands in the near-fault region, Earthquake Spectra Volume 24, Issue 1, pp. 319-341.

Luco, Nicolas, Elingwood, B.R., Hamburger, R.O., Hooper, J.D., Kimball, J.K., and Kireher, C.A., 2007, Seismic hazard analysis for the State of Alaska, U.S. Geological Survey, Open-File Report 2007-1043.

Wesson, Robert L., Boyd, Oliver S., Mueller, Charles S., Bufe, Charles G., Frankel, Arthur D., Petersen, Mark D., 2007, Revision of time-independent probabilistic seismic hazard maps for Alaska: U.S. Geological Survey Open-File Report 2007-1043.

Map prepared by U.S. Geological Survey in collaboration with the Federal Emergency Management Agency (FEMA)-funded Building Seismic Safety Council's (BSSC) Code Resource Support Committee (CRSC).

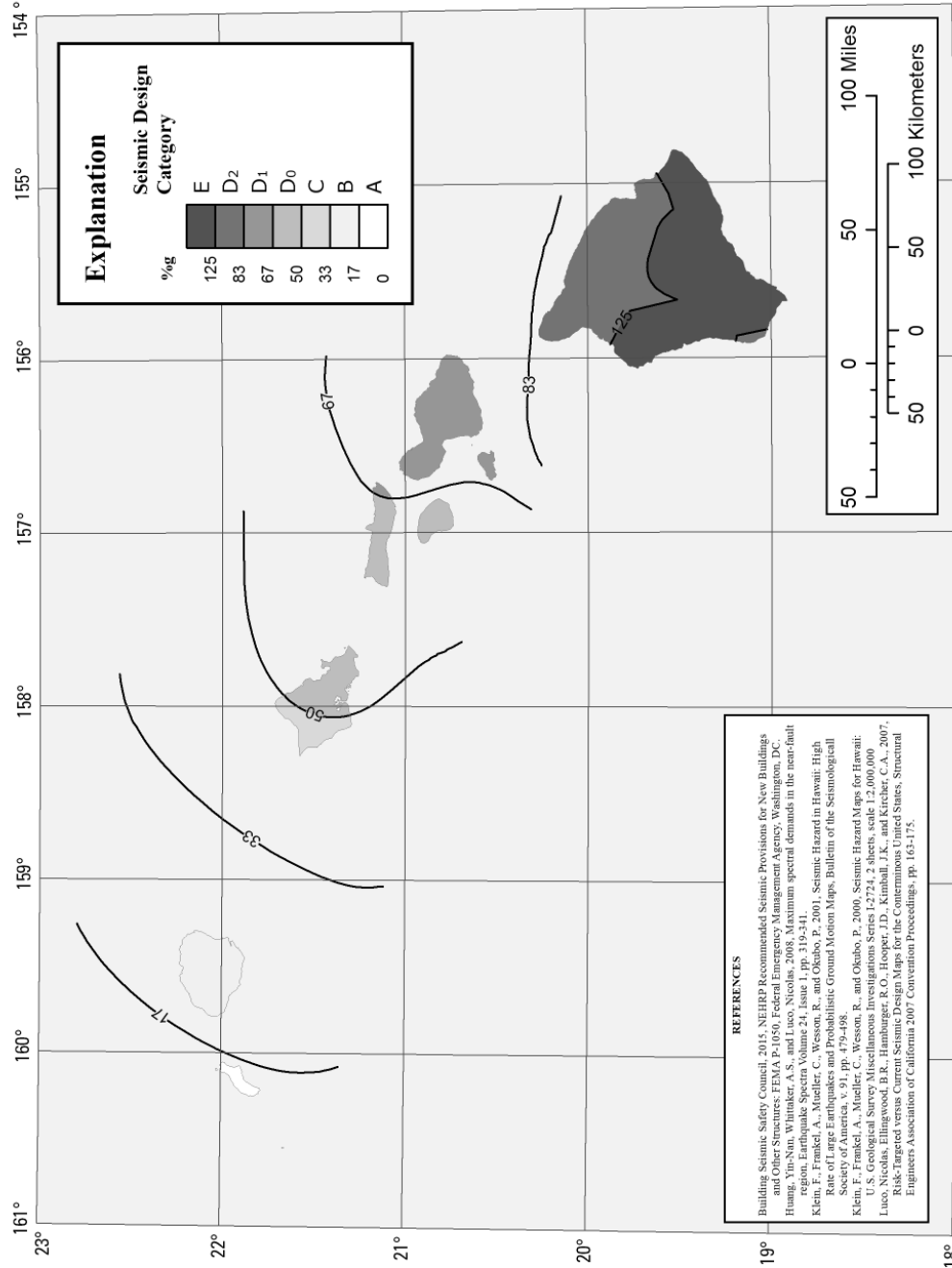
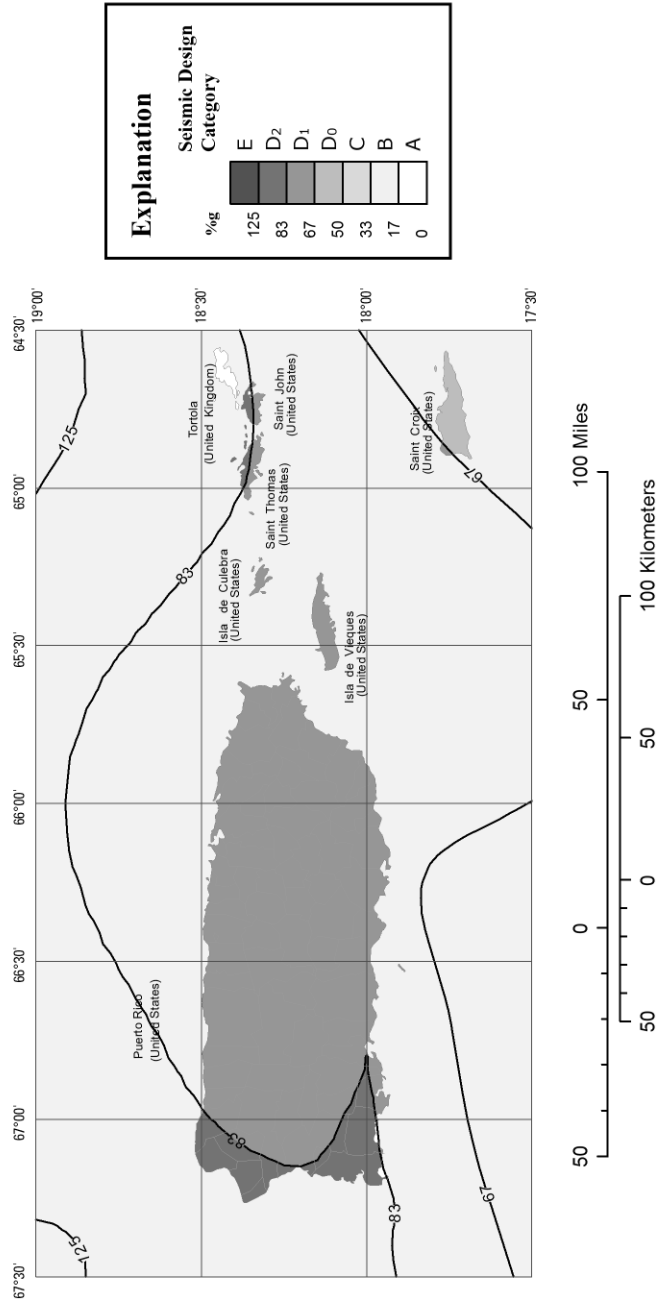

FIGURE R301.2(3)—continued
 ALTERNATE SEISMIC DESIGN CATEGORIES
 (continued)



REFERENCES

Building Seismic Safety Council. 2015. NEHRP Recommended Seismic Provisions for New Buildings and Other Structures: FEMA P-1050. Federal Emergency Management Agency, Washington, DC.

Huang, Yin-Nan, Whitaker, A.S., and Luco, Nicolas. 2008. Maximum spectral demands in the near-fault region. Earthquake Spectra Volume 24, Issue 1, pp. 319-341.

Luco, Nicolas, Ellingwood, B.R., Hamburger, R.O., Hooper, J.D., Kimball, J.K., and Kirecher, C.A., 2007. Risk-Targeted versus Current Seismic Design Maps for the Conterminous United States. Structural Engineering and Earthquake Engineering, California Institute of Technology, 16:1-15.

Mueller, C., Frankel, A., Petersen, M., and Leyendecker, E. 2003. Documentation for 2003 USGS Seismic Hazard Maps for Puerto Rico and the U.S. Virgin Islands. U.S. Geological Survey Open-File Report 03-379.

Map prepared by U.S. Geological Survey in collaboration with the Federal Emergency Management Agency (FEMA)-funded Building Seismic Safety Council's (BSSC) Code Resource Support Committee (CRSC).

FIGURE R301.2(3)—continued
ALTERNATE SEISMIC DESIGN CATEGORIES

(continued)

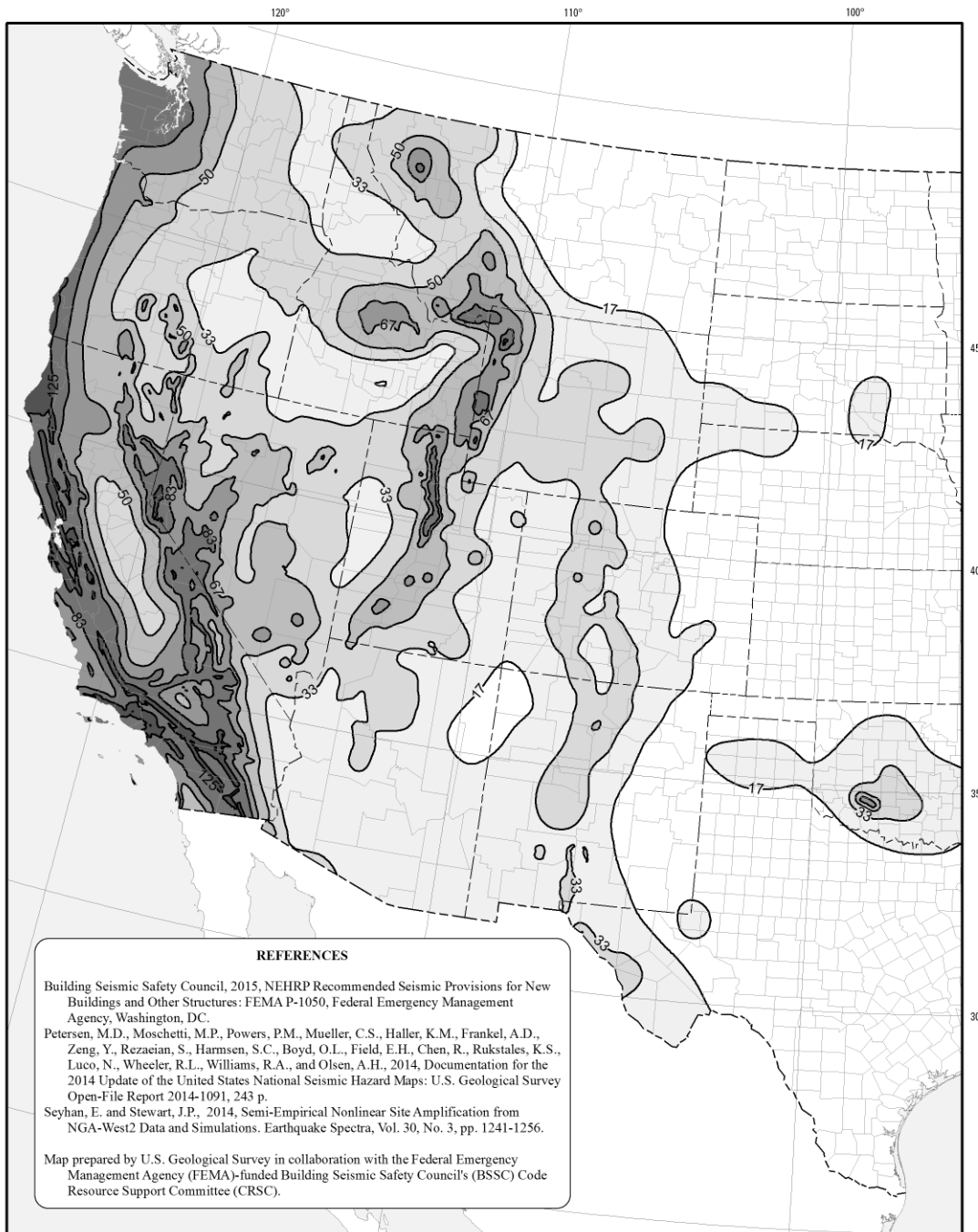

**FIGURE R301.2(3)—continued
ALTERNATE SEISMIC DESIGN CATEGORIES**

(continued)

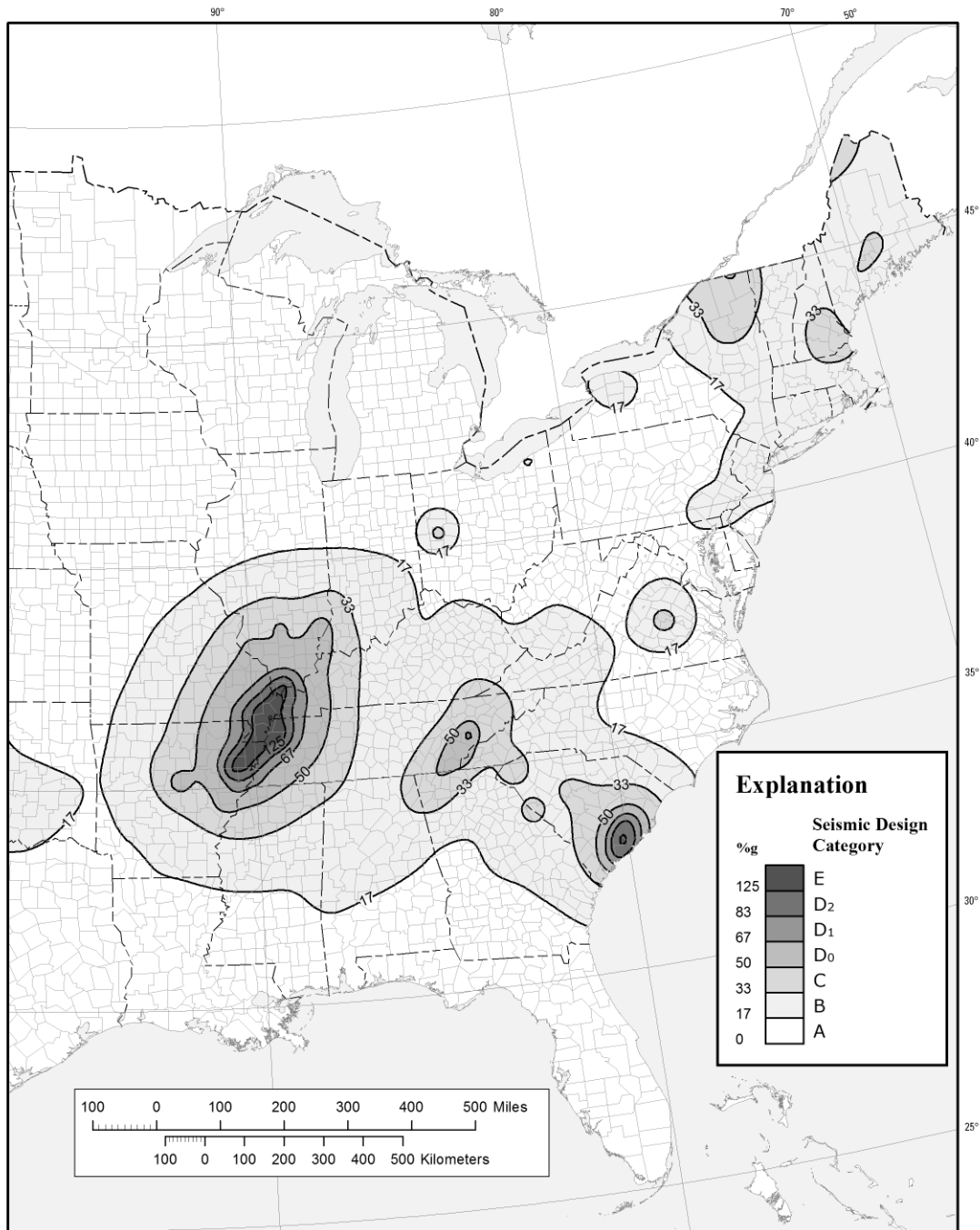
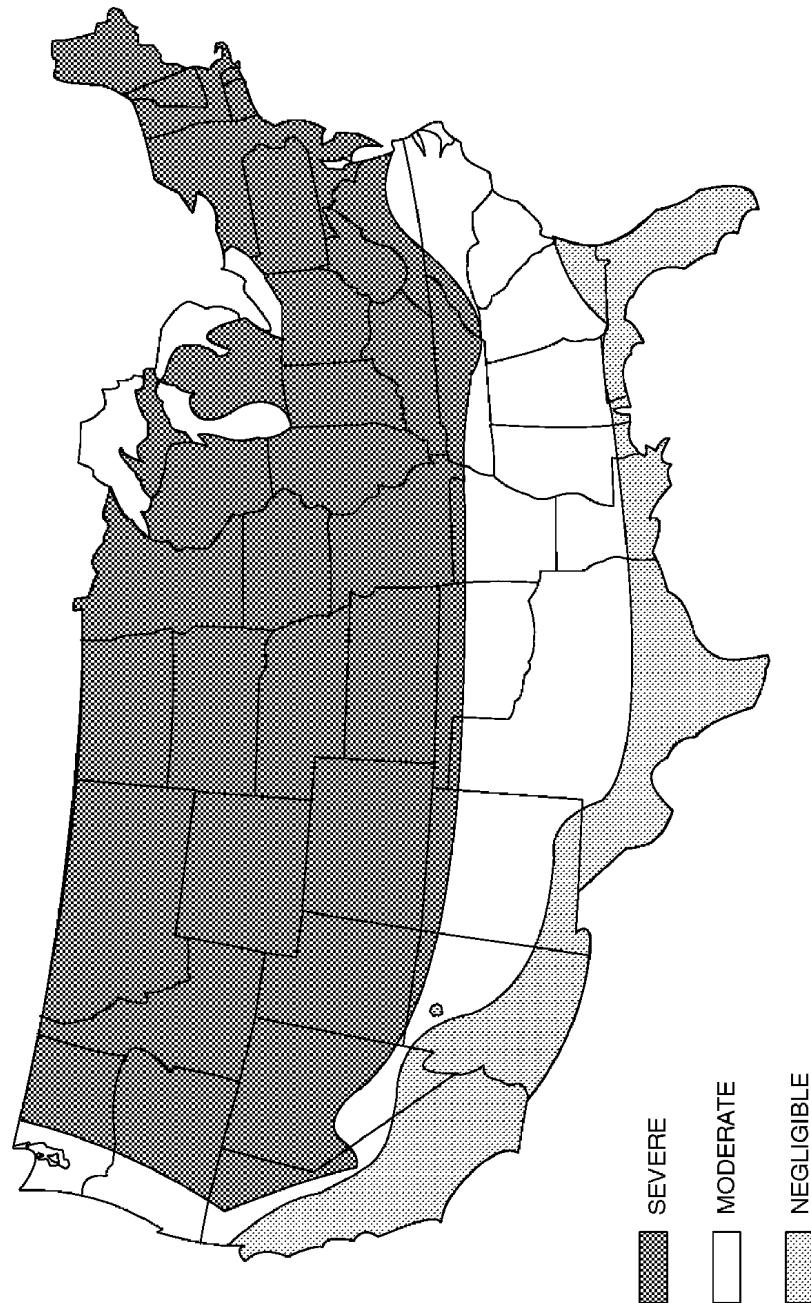

FIGURE R301.2(3)—continued
ALTERNATE SEISMIC DESIGN CATEGORIES



a. Alaska and Hawaii are classified as severe and negligible, respectively.

b. Lines defining areas are approximate only. Local conditions may be more or less severe than indicated by region classification. A severe classification is where weather conditions result in significant snowfall combined with extended periods during which there is little or no natural thawing causing deicing salts to be used extensively.

FIGURE R301.2(4)
WEATHERING PROBABILITY MAP FOR CONCRETE^{a, b}

R301.2.3 Snow loads. Wood-framed construction, cold-formed, steel-framed construction and masonry and concrete construction, and structural insulated panel construction in regions with ground snow loads 70 pounds per square foot (3.35 kPa) or less, shall be in accordance with Chapters 5, 6 and 8. Buildings in regions with ground snow loads greater than 70 pounds per square foot (3.35 kPa) shall be designed in accordance with accepted engineering practice.

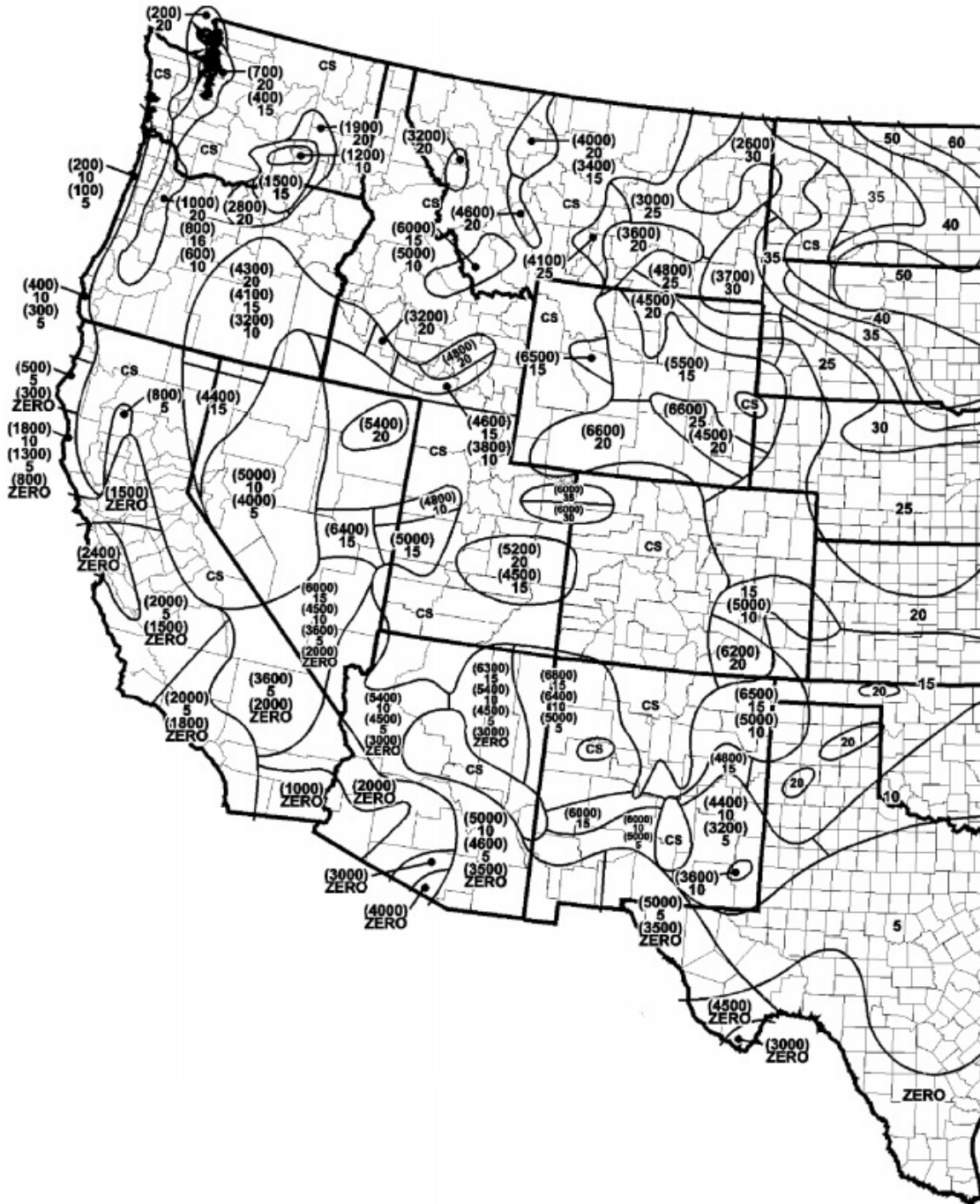

For SI: 1 foot = 304.8 mm, 1 pound per square foot = 0.0479 kPa, 1 mile = 1.61 km.

- a. In CS areas, site-specific Case Studies are required to establish ground snow loads. Extreme local variations in ground snow loads in these areas preclude mapping at this scale.
- b. Numbers in parentheses represent the upper elevation limits in feet for the ground snow load values presented below. Site-specific case studies are required to establish ground snow loads at elevations not covered.

FIGURE R301.2(6)
GROUND SNOW LOADS, P_g , FOR THE UNITED STATES (lb/ft²)

(continued)

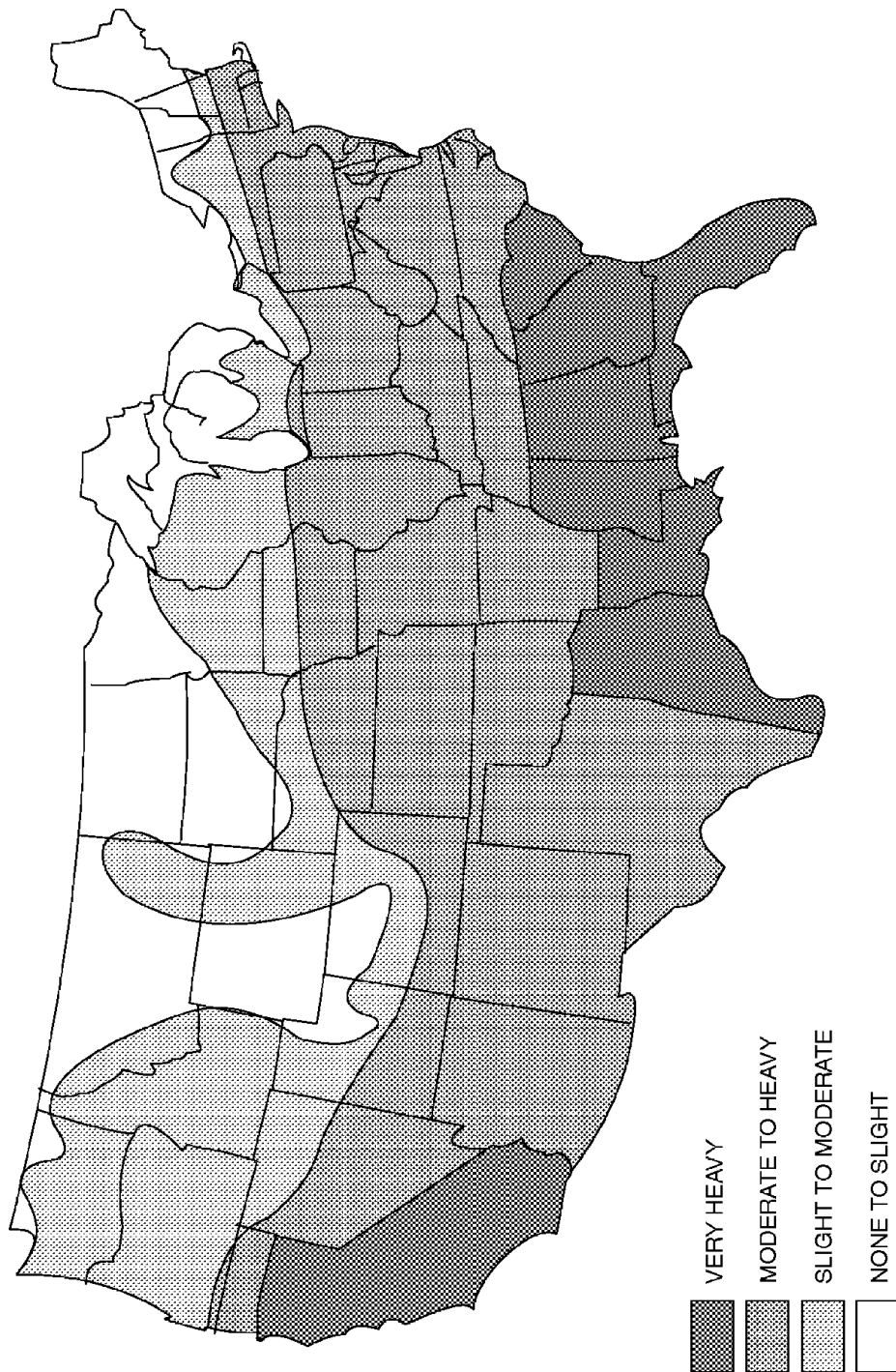

FIGURE R301.2(6)—continued
GROUND SNOW LOADS, P_g , FOR THE UNITED STATES (lb/ft^2)

R301.2.4 Floodplain construction. Buildings and structures constructed in whole or in part in flood hazard areas (including A or V Zones) as established in Table R301.2(1), and substantial improvement and *repair* of substantial damage of buildings and structures in flood hazard areas, shall be designed and constructed in accordance with Section R322. Buildings and structures that are located in more than one flood hazard area shall comply with the provisions associated with the most restrictive

flood hazard area. Buildings and structures located in whole or in part in identified floodways shall be designed and constructed in accordance with ASCE 24.

R301.2.4.1 Alternative provisions. As an alternative to the requirements in Section R322, ASCE 24 is permitted subject to the limitations of this code and the limitations therein.



Note: Lines defining areas are approximate only. Local conditions may be more or less severe than indicated by the region classification.

FIGURE R301.2(7)
TERMITE INFESTATION PROBABILITY MAP

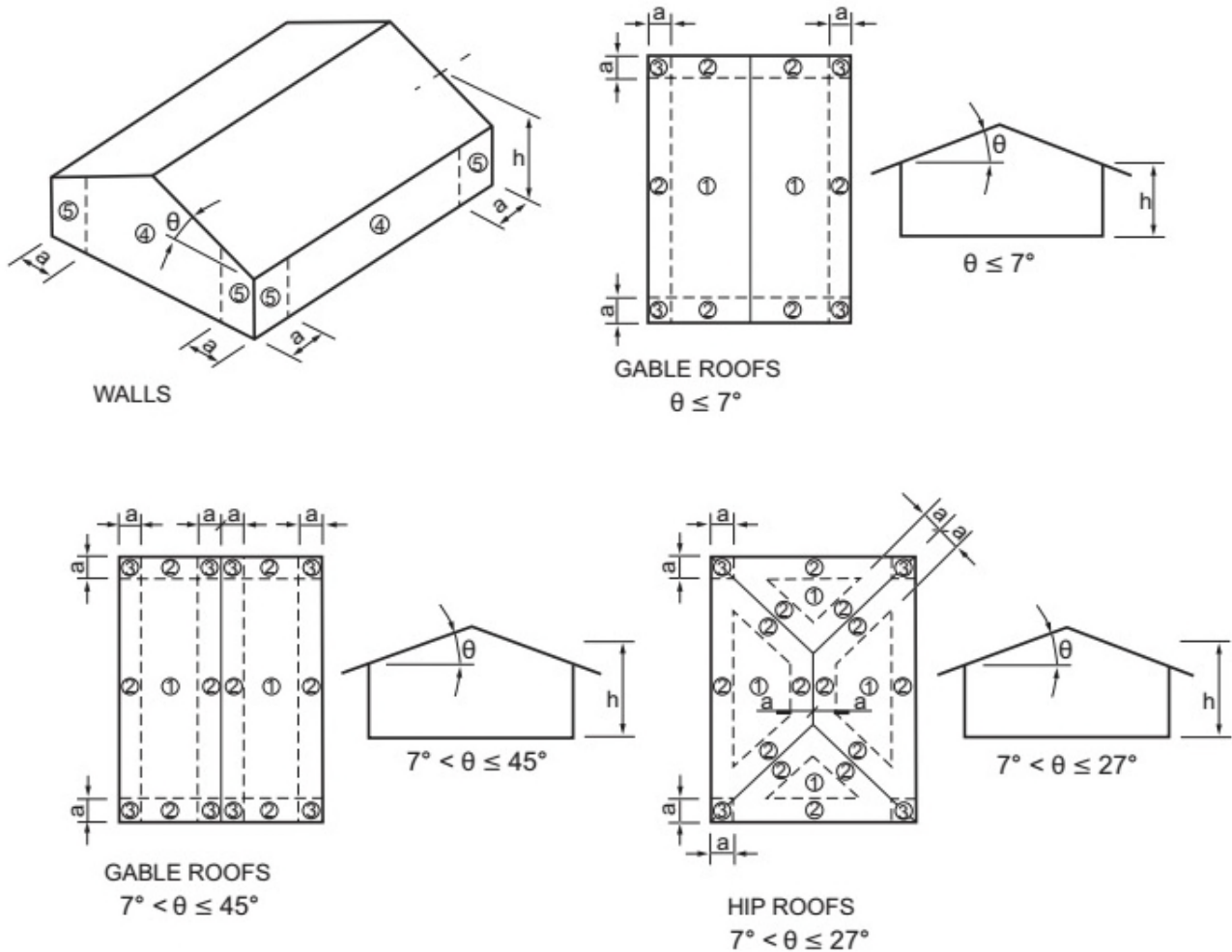

For SI: 1 foot = 304.8 mm, 1 degree = 0.0175 rad.
 Note: a = 4 feet in all cases.

FIGURE R301.2(8)
COMPONENT AND CLADDING PRESSURE ZONES

R301.3 Story height. The wind and seismic provisions of this code shall apply to buildings with *story heights* not exceeding the following:

1. For wood wall framing, the *story height* shall not exceed 11 feet 7 inches (3531 mm) and the laterally unsupported bearing wall stud height permitted by Table R602.3(5).
2. For cold-formed steel wall framing, the *story height* shall be not more than 11 feet 7 inches (3531 mm) and the unsupported bearing wall stud height shall be not more than 10 feet (3048 mm).
3. For masonry walls, the *story height* shall be not more than 13 feet 7 inches (4140 mm) and the bearing wall clear height shall be not more than 12 feet (3658 mm).

Exception: An additional 8 feet (2438 mm) of bearing wall clear height is permitted for gable end walls.

4. For insulating concrete form walls, the maximum *story height* shall not exceed 11 feet 7 inches (3531 mm) and the maximum unsupported wall height per *story* as permitted by Section R608 tables shall not exceed 10 feet (3048 mm).
5. For structural insulated panel (SIP) walls, the *story height* shall be not more than 11 feet 7 inches (3531 mm) and the bearing wall height per *story* as permitted by Section R610 tables shall not exceed 10 feet (3048 mm).

Individual walls or wall studs shall be permitted to exceed these limits as permitted by Chapter 6 provisions, provided that *story heights* are not exceeded. An engineered design shall be provided for the wall or wall framing members where the limits of

Chapter 6 are exceeded. Where the *story height* limits of this section are exceeded, the design of the building, or the noncompliant portions thereof, to resist wind and seismic loads shall be in accordance with the *International Building Code*.

R301.4 Dead load. The actual weights of materials and construction shall be used for determining dead load with consideration for the dead load of fixed service *equipment*.

R301.5 Live load. The minimum uniformly distributed live load shall be as provided in Table R301.5.

[W][S] TABLE R301.5
MINIMUM UNIFORMLY DISTRIBUTED LIVE LOADS
 (in pounds per square foot)

USE	LIVE LOAD
Uninhabitable attics without storage ^b	10
Uninhabitable attics with limited storage ^{b, g}	20
Habitable attics and attics served with fixed stairs	30
Balconies (exterior) and decks ^e	((40)) 60 ⁱ
Fire escapes	40
Guards and handrails ^d	200 ^h
Guard in-fill components ^f	50 ^h
Passenger vehicle garages ^a	50 ^a
Rooms other than sleeping rooms	40
Sleeping rooms	30
Stairs	40 ^c

For SI: 1 pound per square foot = 0.0479 kPa, 1 square inch = 645 mm²,
 1 pound = 4.45 N.

- a. Elevated garage floors shall be capable of supporting a 2,000-pound load applied over a 20-square-inch area.
- b. Uninhabitable attics without storage are those where the clear height between joists and rafters is not more than 42 inches, or where there are not two or more adjacent trusses with web configurations capable of accommodating an assumed rectangle 42 inches in height by 24 inches in width, or greater, within the plane of the trusses. This live load need not be assumed to act concurrently with any other live load requirements.
- c. Individual stair treads shall be designed for the uniformly distributed live load or a 300-pound concentrated load acting over an area of 4 square inches, whichever produces the greater stresses.
- d. A single concentrated load applied in any direction at any point along the top.
- e. See Section R507.1 for decks attached to exterior walls.
- f. Guard in-fill components (all those except the handrail), balusters and panel fillers shall be designed to withstand a horizontally applied normal load of 50 pounds on an area equal to 1 square foot. This load need not be assumed to act concurrently with any other live load requirement.
- g. Uninhabitable attics with limited storage are those where the clear height between joists and rafters is 42 inches or greater, or where there are two or more adjacent trusses with web configurations capable of accommodating an assumed rectangle 42 inches in height by 24 inches in width, or greater, within the plane of the trusses.
 - The live load need only be applied to those portions of the joists or truss bottom chords where all of the following conditions are met:
 1. The attic area is accessed from an opening not less than 20 inches in width by 30 inches in length that is located where the clear height in the attic is not less than 30 inches.
 2. The slopes of the joists or truss bottom chords are not greater than 2 inches vertical to 12 units horizontal.
 3. Required insulation depth is less than the joist or truss bottom chord member depth.
 The remaining portions of the joists or truss bottom chords shall be designed for a uniformly distributed concurrent live load of not less than 10 pounds per square foot.
- h. Glazing used in handrail assemblies and guards shall be designed with a safety factor of 4. The safety factor shall be applied to each of the concentrated loads applied to the top of the rail, and to the load on the in-fill components. These loads shall be determined independent of one another, and loads are assumed not to occur with any other live load.
- i. Where structural tables in Section R507 only specify snow loads, the values corresponding to 70 psf snow loads shall be used.

R301.6 Roof load. The roof shall be designed for the live load indicated in Table R301.6 or the snow load indicated in Table R301.2(1), whichever is greater.

**TABLE R301.6
MINIMUM ROOF LIVE LOADS IN POUNDS-FORCE
PER SQUARE FOOT OF HORIZONTAL PROJECTION**

ROOF SLOPE	TRIBUTARY LOADED AREA IN SQUARE FEET FOR ANY STRUCTURAL MEMBER		
	0 to 200	201 to 600	Over 600
Flat or rise less than 4 inches per foot (1:3)	20	16	12
Rise 4 inches per foot (1:3) to less than 12 inches per foot (1:1)	16	14	12
Rise 12 inches per foot (1:1) and greater	12	12	12

For SI: 1 square foot = 0.0929 m², 1 pound per square foot = 0.0479 kPa,
1 inch per foot = 83.3 mm/m.

R301.7 Deflection. The allowable deflection of any structural member under the live load listed in Sections R301.5 and R301.6 or wind loads determined by Section R301.2.1 shall not exceed the values in Table R301.7.

**TABLE R301.7
ALLOWABLE DEFLECTION OF STRUCTURAL MEMBERS^{b, c}**

STRUCTURAL MEMBER	ALLOWABLE DEFLECTION
Rafters having slopes greater than 3:12 with finished ceiling not attached to rafters	<i>L</i> /180
Interior walls and partitions	<i>H</i> /180
Floors	<i>L</i> /360
Ceilings with brittle finishes (including plaster and stucco)	<i>L</i> /360
Ceilings with flexible finishes (including gypsum board)	<i>L</i> /240
All other structural members	<i>L</i> /240
Exterior walls—wind loads ^a with plaster or stucco finish	<i>H</i> /360
Exterior walls—wind loads ^a with other brittle finishes	<i>H</i> /240
Exterior walls—wind loads ^a with flexible finishes	<i>H</i> /120 ^d
Lintels supporting masonry veneer walls ^e	<i>L</i> /600

Note: *L* = span length, *H* = span height.

- a. For the purpose of the determining deflection limits herein, the wind load shall be permitted to be taken as 0.7 times the component and cladding (ASD) loads obtained from Table R301.2(2).
- b. For cantilever members, *L* shall be taken as twice the length of the cantilever.
- c. For aluminum structural members or panels used in roofs or walls of sunroom additions or patio covers, not supporting edge of glass or sandwich panels, the total load deflection shall not exceed *L*/60. For continuous aluminum structural members supporting edge of glass, the total load deflection shall not exceed *L*/175 for each glass lite or *L*/60 for the entire length of the member, whichever is more stringent. For sandwich panels used in roofs or walls of sunroom additions or patio covers, the total load deflection shall not exceed *L*/120.
- d. Deflection for exterior walls with interior gypsum board finish shall be limited to an allowable deflection of *H*/180.
- e. Refer to Section R703.8.2.

R301.8 Nominal sizes. For the purposes of this code, dimensions of lumber specified shall be deemed to be nominal dimensions unless specifically designated as actual dimensions.

**SECTION R302
FIRE-RESISTANT CONSTRUCTION**

[S] R302.1 Exterior walls. Construction, projections, openings and penetrations of *exterior walls* of *dwellings* and accessory buildings shall comply with Table R302.1(1); or *dwellings* equipped throughout with an *automatic sprinkler system* installed in accordance with Section P2904 shall comply with Table R302.1(2).

Exceptions:

- 1. Walls, projections, openings or penetrations in walls perpendicular to the line used to determine the *fire separation distance*.
- 2. Walls of *individual dwelling units* and their *accessory structures* located on the same *lot*.
- 3. Detached tool sheds and storage sheds, playhouses and similar structures exempted from permits by Section R105.2 are not required to provide ((wall)) protection based on location on the *lot*. Projections beyond the *exterior wall* shall not extend over the *lot line*.

BUILDING PLANNING

4. Detached garages accessory to a *dwelling* located within 2 feet (610 mm) of a *lot line* are permitted to have roof eave projections not exceeding 4 inches (102 mm).
5. Foundation vents installed in compliance with this code are permitted.

Interpretation R302.1: For purposes of Section R302.1, gutters 6 inches (152 mm) or less in width that are not an integral part of the structure are not considered projections.

**[W] TABLE R302.1(1)
EXTERIOR WALLS**

EXTERIOR WALL ELEMENT		MINIMUM FIRE-RESISTANCE RATING	MINIMUM FIRE SEPARATION DISTANCE
Walls	Fire-resistance rated	1 hour—tested in accordance with ASTM E119, UL 263 or Section 703.3 of the <i>International Building Code</i> with exposure from both sides	0 feet
	Not fire-resistance rated	0 hours	≥ 5 feet
Projections	Not allowed	NA	< 2 feet
	Fire-resistance rated	1 hour on the underside, or heavy timber, or fire-retardant-treated wood ^{a, b}	≥ 2 feet to < 5 feet
	Not fire-resistance rated	0 hours	≥ 5 feet
Openings in walls	Not allowed	NA	< 3 feet
	25% maximum of wall area	0 hours	3 feet
	Unlimited	0 hours	5 feet
Penetrations	All	Comply with Section R302.4	< 3 feet
		None required	3 feet

For SI: 1 foot = 304.8 mm.

NA = Not Applicable.

- a. The fire-resistance rating shall be permitted to be reduced to 0 hours on the underside of the eave overhang if fireblocking is provided from the wall top plate to the underside of the roof sheathing.
- b. The fire-resistance rating shall be permitted to be reduced to 0 hours on the underside of the rake overhang where ((~~gable vent~~)) ventilation openings are not installed in the rake overhang or in walls that are common to attic areas.

**[W] TABLE R302.1(2)
EXTERIOR WALLS—DWELLINGS WITH FIRE SPRINKLERS**

EXTERIOR WALL ELEMENT		MINIMUM FIRE-RESISTANCE RATING	MINIMUM FIRE SEPARATION DISTANCE
Walls	Fire-resistance rated	1 hour—tested in accordance with ASTM E119, UL 263 or Section 703.3 of the <i>International Building Code</i> with exposure from the outside	0 feet
	Not fire-resistance rated	0 hours	3 feet ^a
Projections	Not allowed	NA	< 2 feet
	Fire-resistance rated	1 hour on the underside, or heavy timber, or fire-retardant-treated wood ^{b, c}	2 feet ^a
	Not fire-resistance rated	0 hours	3 feet
Openings in walls	Not allowed	NA	< 3 feet
	Unlimited	0 hours	3 feet ^a
Penetrations	All	Comply with Section R302.4	< 3 feet
		None required	3 feet ^a

For SI: 1 foot = 304.8 mm.

NA = Not Applicable.

- a. For residential subdivisions where all dwellings are equipped throughout with an automatic sprinkler system installed in accordance with Section P2904, the fire separation distance for exterior walls not fire-resistance rated and for fire-resistance-rated projections shall be permitted to be reduced to 0 feet, and unlimited unprotected openings and penetrations shall be permitted, where the adjoining lot provides an open setback yard that is 6 feet or more in width on the opposite side of the property line.
- b. The fire-resistance rating shall be permitted to be reduced to 0 hours on the underside of the eave overhang if fireblocking is provided from the wall top plate to the underside of the roof sheathing.
- c. The fire-resistance rating shall be permitted to be reduced to 0 hours on the underside of the rake overhang where ((~~gable vent~~)) ventilation openings are not installed in the rake overhang or in walls that are common to attic areas.

[W] **R302.2 Townhouses.** Walls separating townhouse units shall be constructed in accordance with Section R302.2.1 or R302.2.2.

[W] **R302.2.1 Double walls.** Each townhouse unit shall be separated from other townhouse units by two 1-hour fire-resistance-rated wall assemblies tested in accordance with ASTM E119, UL 263 or Section 703.3 of the *International Building Code*.

[W] **R302.2.2 Common walls.** Common walls separating ~~((townhouses))~~ townhouse units shall be assigned a fire-resistance rating in accordance with Item 1 or 2. The common wall shared by two ~~((townhouses))~~ townhouse units shall be constructed without plumbing or mechanical equipment, ducts or vents in the cavity of the common wall. The wall shall be rated for fire exposure from both sides and shall extend to and be tight against exterior walls and the underside of the roof sheathing. Electrical installations shall be in accordance with ~~((Chapters 34 through 43))~~ the Seattle Electrical Code. Penetrations of the membrane of common walls for electrical outlet boxes shall be in accordance with Section R302.4.

1. Where a fire sprinkler system in accordance with Section P2904 is provided, the common wall shall be not less than a 1-hour fire-resistance-rated wall assembly tested in accordance with ASTM E119, UL 263 or Section 703.3 of the *International Building Code*.
2. Where a fire sprinkler system in accordance with Section P2904 is not provided, the common wall shall be not less than a 2-hour fire-resistance-rated wall assembly tested in accordance with ASTM E119, UL 263 or Section 703.3 of the *International Building Code*.

Exception: Common walls are permitted to extend to and be tight against the interior side of the exterior walls where voids in the exterior wall at the end of the common wall are fireblocked.

[W] **R302.2.3 Continuity.** The fire-resistance-rated wall or assembly separating ~~((townhouses))~~ townhouse units shall be continuous from the foundation to the underside of the roof sheathing, deck or slab. The fire-resistance rating shall extend the full length of the wall or assembly, including wall extensions through and separating attached enclosed *accessory structures*.

Where a story extends beyond the exterior wall of a story below:

1. The fire-resistance-rated wall or assembly shall extend to the outside edge of the upper story (see Figure R302.2(1)); or
2. The underside of the exposed floor-ceiling assembly shall be protected as required for projections in Section R302 (see Figure R302.2(2)).

[W] **R302.2.4 Parapets for townhouses.** Parapets constructed in accordance with Section R302.2.5 shall be constructed for *townhouses* as an extension of exterior walls or common walls separating townhouse units in accordance with the following:

1. Where roof surfaces adjacent to the wall or walls are at the same elevation, the parapet shall extend not less than 30 inches (762 mm) above the roof surfaces.
2. Where roof surfaces adjacent to the wall or walls are at different elevations and the higher roof is not more than 30 inches (762 mm) above the lower roof, the parapet shall extend not less than 30 inches (762 mm) above the lower roof surface.

Exception: A parapet is not required in the preceding two cases where the roof covering complies with a minimum Class C rating as tested in accordance with ASTM E108 or UL 790 and the roof decking or sheathing is of noncombustible materials or fire-retardant-treated wood for a distance of 4 feet (1219 mm) on each side of the wall or walls, or one layer of 5/8-inch (15.9 mm) Type X gypsum board is installed directly beneath the roof decking or sheathing, supported by not less than nominal 2-inch (51 mm) ledgers attached to the sides of the roof framing members, for a distance of not less than 4 feet (1219 mm) on each side of the wall or walls and any openings or penetrations in the roof are not within 4 feet (1219 mm) of the common walls. Fire-retardant-treated wood shall meet the requirements of Sections R802.1.5 and R803.2.1.2.

3. A parapet is not required where roof surfaces adjacent to the wall or walls are at different elevations and the higher roof is more than 30 inches (762 mm) above the lower roof. The common wall construction from the lower roof to the underside of the higher roof deck shall have not less than a 1-hour fire-resistance rating. The wall shall be rated for exposure from both sides.

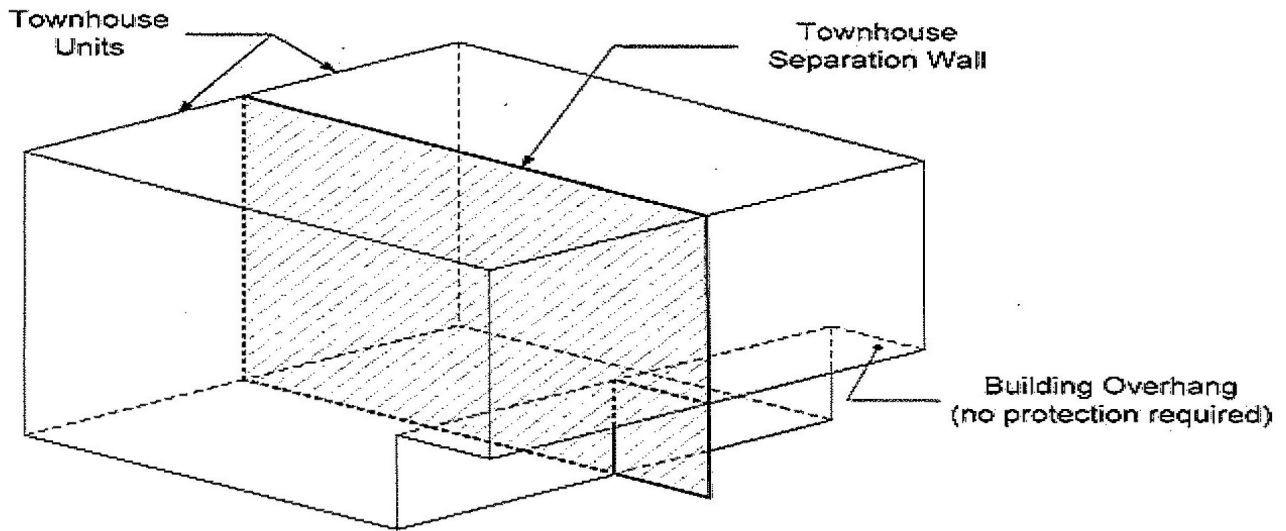

[W] FIGURE R302.2(1)
EXTENDED TOWNHOUSE SEPARATION WALL

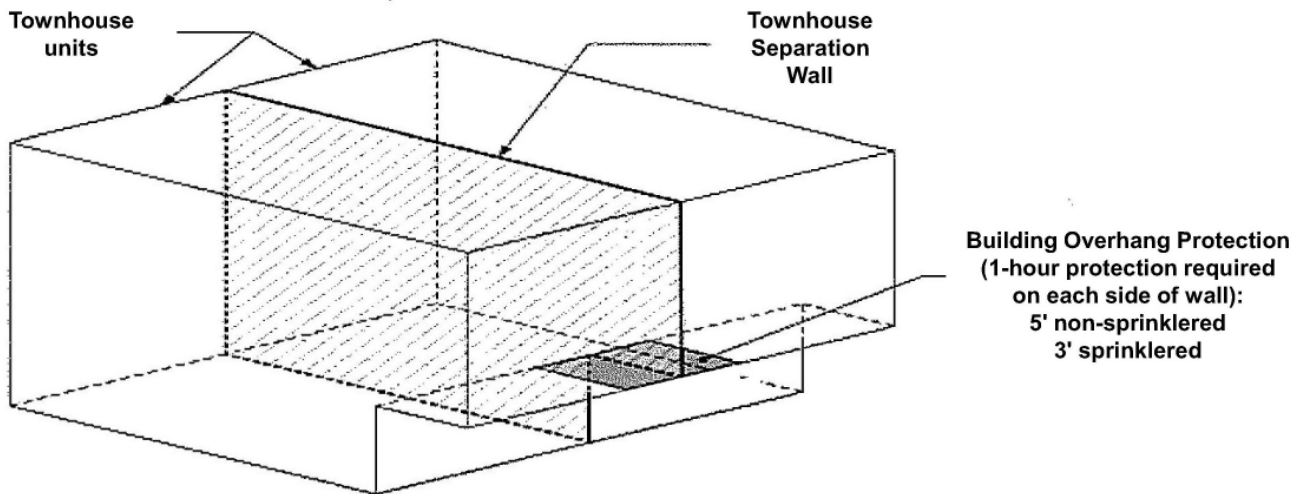

[W] FIGURE R302.2(2)
TOWNHOUSE SEPARATION OVERHANG PROTECTION

R302.2.5 Parapet construction. Parapets shall have the same fire-resistance rating as that required for the supporting wall or walls. On any side adjacent to a roof surface, the parapet shall have noncombustible faces for the uppermost 18 inches (457 mm), to include counterflashing and coping materials. Where the roof slopes toward a parapet at slopes greater than 2 units vertical in 12 units horizontal (16.7-percent slope), the parapet shall extend to the same height as any portion of the roof within a distance of 3 feet (914 mm), and the height shall be not less than 30 inches (762 mm).

[W] (~~R302.2.6 Structural independence.~~ Each individual *townhouse* shall be structurally independent.

Exceptions:

1. Foundations supporting *exterior walls* or common walls.
2. Structural roof and wall sheathing from each unit fastened to the common wall framing.
3. Nonstructural wall and roof coverings.
4. Flashing at termination of roof covering over common wall.
5. *Townhouses* separated by a common wall as provided in Section R302.2.2, Item 1 or 2.)

[W] R302.3 Two-family dwellings. Wall and floor/ceiling assemblies separating dwelling units in two-family dwellings shall be constructed in accordance with Section R302.3.1 or R302.3.3. One accessory dwelling unit constructed within an existing dwelling unit need not be considered a separated dwelling unit in a two-family dwelling where all required smoke alarms, in the accessory dwelling unit and the primary dwelling unit, are interconnected in such a manner that the actuation of one alarm will activate all alarms in both the primary dwelling unit and the accessory dwelling unit.

Interpretation I-R302.3. An accessory dwelling unit within an existing or new two-family dwelling is considered a separate dwelling unit and exceeds the unit count allowed by the *Seattle Residential Code*.

[W][S] R302.3.1 *Dwelling units* in two-family dwellings shall be separated from each other by wall and floor assemblies having not less than a 1-hour fire-resistance rating where tested in accordance with ASTM E119, UL 263 or Section 703.3 of the *International Building Code*. (~~Fire-resistance-rated floor/ceiling and wall assemblies shall extend to and be tight against the exterior wall, and wall assemblies shall extend from the foundation to the underside of the roof sheathing.~~)

~~(Exceptions)~~ **Exception:** (~~(1-)~~) A fire-resistance rating of 1/2 hour shall be permitted in buildings equipped throughout with an automatic sprinkler system installed in accordance with NFPA 13.

[W] R302.3.2 Fire-resistance-rated floor/ceiling and wall assemblies shall extend to and be tight against the exterior wall, and wall assemblies shall extend from the foundation to the underside of the roof sheathing.

~~(2-)~~ **Exception:** Wall assemblies need not extend through *attic* spaces where the ceiling is protected by not less than 5/8-inch (15.9 mm) Type X gypsum board, an *attic* draft stop constructed as specified in Section R302.12.1 is provided above and along the wall assembly separating the *dwellings* and the structural framing supporting the ceiling is protected by not less than 1/2-inch (12.7 mm) gypsum board or equivalent.

[W][S] (~~R302.3.1~~) R302.3.3 Supporting construction. Where floor/ceiling assemblies are required to be fire-resistance rated by Section R302.3, the supporting construction of such assemblies shall have an equal or greater fire-resistance rating.

Exception: The supporting construction is not required to be fire-resistance rated where automatic fire sprinklers are installed in accordance with Section P2904 in both *dwelling units*.

R302.4 Dwelling unit rated penetrations. Penetrations of wall or floor-ceiling assemblies required to be fire-resistance rated in accordance with Section R302.2 or R302.3 shall be protected in accordance with this section.

[W] R302.4.1 Through penetrations. Through penetrations of fire-resistance-rated wall or floor assemblies shall comply with Section R302.4.1.1 or R302.4.1.2.

Exception: Where the penetrating items are steel, ferrous or copper pipes, tubes or conduits, or fire sprinkler piping, the annular space shall be protected as follows:

1. In concrete or masonry wall or floor assemblies, concrete, grout or mortar shall be permitted where installed to the full thickness of the wall or floor assembly or the thickness required to maintain the fire-resistance rating, provided that both of the following are complied with:
 - 1.1. The nominal diameter of the penetrating item is not more than 6 inches (152 mm).
 - 1.2. The area of the opening through the wall does not exceed 144 square inches (92 900 mm²).
2. The material used to fill the annular space shall prevent the passage of flame and hot gases sufficient to ignite cotton waste where subjected to ASTM E119 or UL 263 time temperature fire conditions under a positive pressure differential of not less than 0.01 inch of water (3 Pa) at the location of the penetration for the time period equivalent to the fire-resistance rating of the construction penetrated.

R302.4.1.1 Fire-resistance-rated assembly. Penetrations shall be installed as tested in the *approved* fire-resistance-rated assembly.

R302.4.1.2 Penetration firestop system. Penetrations shall be protected by an *approved* penetration firestop system installed as tested in accordance with ASTM E814 or UL 1479, with a positive pressure differential of not less than 0.01 inch of water (3 Pa) and shall have an F rating of not less than the required fire-resistance rating of the wall or floor-ceiling assembly penetrated.

R302.4.2 Membrane penetrations. Membrane penetrations shall comply with Section R302.4.1. Where walls are required to have a fire-resistance rating, recessed fixtures shall be installed so that the required fire-resistance rating will not be reduced.

Exceptions:

1. Membrane penetrations of not more than 2-hour fire-resistance-rated walls and partitions by steel electrical boxes that do not exceed 16 square inches (0.0103 m²) in area provided that the aggregate area of the openings through the membrane does not exceed 100 square inches (0.0645 m²) in any 100 square feet (9.29 m²) of wall area. The annular space between the wall membrane and the box shall not exceed 1/8 inch (3.1 mm). Such boxes on opposite sides of the wall shall be separated by one of the following:
 - 1.1. By a horizontal distance of not less than 24 inches (610 mm) where the wall or partition is constructed with individual noncommunicating stud cavities.
 - 1.2. By a horizontal distance of not less than the depth of the wall cavity where the wall cavity is filled with cellulose loose-fill, rockwool or slag mineral wool insulation.
 - 1.3. By solid fireblocking in accordance with Section R302.11.
 - 1.4. By protecting both boxes with *listed* putty pads.
 - 1.5. By other *listed* materials and methods.
2. Membrane penetrations by *listed* electrical boxes of any materials provided that the boxes have been tested for use in fire-resistance-rated assemblies and are installed in accordance with the instructions included in the *listing*. The annular space between the wall membrane and the box shall not exceed 1/8 inch (3.1 mm) unless *listed* otherwise. Such boxes on opposite sides of the wall shall be separated by one of the following:
 - 2.1. By the horizontal distance specified in the *listing* of the electrical boxes.
 - 2.2. By solid fireblocking in accordance with Section R302.11.
 - 2.3. By protecting both boxes with *listed* putty pads.
 - 2.4. By other *listed* materials and methods.
3. The annular space created by the penetration of a fire sprinkler provided that it is covered by a metal escutcheon plate.
4. Ceiling membrane penetrations by *listed* luminaires or by luminaires protected with *listed* materials that have been tested for use in fire-resistance-rated assemblies and are installed in accordance with the instructions included in the *listing*.

R302.5 Dwelling-garage opening and penetration protection. Openings and penetrations through the walls or ceilings separating the *dwelling* from the garage shall be in accordance with Sections R302.5.1 through R302.5.3.

R302.5.1 Opening protection. Openings from a private garage directly into a room used for sleeping purposes shall not be permitted. Other openings between the garage and residence shall be equipped with solid wood doors not less than 1-3/8 inches (35 mm) in thickness, solid or honeycomb-core steel doors not less than 1-3/8 inches (35 mm) thick, or 20-minute fire-rated doors, equipped with a self-closing or automatic-closing device.

R302.5.2 Duct penetration. Ducts in the garage and ducts penetrating the walls or ceilings separating the *dwelling* from the garage shall be constructed of a minimum No. 26 gage (0.48 mm) sheet steel or other *approved* material and shall not have openings into the garage.

R302.5.3 Other penetrations. Penetrations through the separation required in Section R302.6 shall be protected as required by Section R302.11, Item 4.

R302.6 Dwelling-garage fire separation. The garage shall be separated as required by Table R302.6. Openings in garage walls shall comply with Section R302.5. Attachment of gypsum board shall comply with Table R702.3.5. The wall separation provisions of Table R302.6 shall not apply to garage walls that are perpendicular to the adjacent *dwelling unit* wall.

**TABLE R302.6
DWELLING-GARAGE SEPARATION**

SEPARATION	MATERIAL
From the residence and attics	Not less than 1/2-inch gypsum board or equivalent applied to the garage side
From habitable rooms above the garage	Not less than 5/8-inch Type X gypsum board or equivalent
Structure(s) supporting floor/ceiling assemblies used for separation required by this section	Not less than 1/2-inch gypsum board or equivalent
Garages located less than 3 feet from a dwelling unit on the same lot	Not less than 1/2-inch gypsum board or equivalent applied to the interior side of exterior walls that are within this area

For SI: 1 inch = 25.4 mm, 1 foot = 304.8 mm.

R302.7 Under-stair protection. Enclosed space under stairs that is *accessed* by a door or access panel shall have walls, under-stair surface and any soffits protected on the enclosed side with 1/2-inch (12.7 mm) gypsum board.

R302.8 Foam plastics. For requirements for foam plastics, see Section R316.

R302.9 Flame spread index and smoke-developed index for wall and ceiling finishes. Flame spread and smoke-developed indices for wall and ceiling finishes shall be in accordance with Sections R302.9.1 through R302.9.4.

R302.9.1 Flame spread index. Wall and ceiling finishes shall have a flame spread index of not greater than 200.

Exception: Flame spread index requirements for finishes shall not apply to trim defined as picture molds, chair rails, baseboards and handrails; to doors and windows or their frames; or to materials that are less than 1/28 inch (0.91 mm) in thickness cemented to the surface of walls or ceilings if these materials exhibit flame spread index values not greater than those of paper of this thickness cemented to a noncombustible backing.

R302.9.2 Smoke-developed index. Wall and ceiling finishes shall have a smoke-developed index of not greater than 450.

R302.9.3 Testing. Tests shall be made in accordance with ASTM E84 or UL 723.

R302.9.4 Alternative test method. As an alternative to having a flame spread index of not greater than 200 and a smoke-developed index of not greater than 450 where tested in accordance with ASTM E84 or UL 723, wall and ceiling finishes shall be permitted to be tested in accordance with NFPA 286. Materials tested in accordance with NFPA 286 shall meet the following criteria:

The interior finish shall comply with the following:

1. During the 40 kW exposure, flames shall not spread to the ceiling.
2. The flame shall not spread to the outer extremity of the sample on any wall or ceiling.
3. Flashover, as defined in NFPA 286, shall not occur.
4. The peak heat release rate throughout the test shall not exceed 800 kW.
5. The total smoke released throughout the test shall not exceed 1,000 m².

R302.10 Flame spread index and smoke-developed index for insulation. Flame spread and smoke-developed index for insulation shall be in accordance with Sections R302.10.1 through R302.10.5.

R302.10.1 Insulation. Insulating materials installed within floor-ceiling assemblies, roof-ceiling assemblies, wall assemblies, crawl spaces and *attics* shall comply with the requirements of this section. They shall exhibit a flame spread index not to exceed 25 and a smoke-developed index not to exceed 450 where tested in accordance with ASTM E84 or UL 723. Insulating materials, where tested in accordance with the requirements of this section, shall include facings, where used, such as vapor retarders, vapor permeable membranes and similar coverings.

Exceptions:

1. Where such materials are installed in concealed spaces, the flame spread index and smoke-developed index limitations do not apply to the facings, provided that the facing is installed in substantial contact with the unexposed surface of the ceiling, floor or wall finish.
2. Cellulose fiber loose-fill insulation that is not spray applied and that complies with the requirements of Section R302.10.3 shall not be required to meet the flame spread index requirements but shall be required to meet a smoke-developed index of not more than 450 where tested in accordance with CAN/ULC S102.2.
3. Foam plastic insulation shall comply with Section R316.

R302.10.2 Loose-fill insulation. Loose-fill insulation materials that cannot be mounted in the ASTM E84 or UL 723 apparatus without a screen or artificial supports shall comply with the flame spread and smoke-developed limits of Section R302.10.1 where tested in accordance with CAN/ULC S102.2.

Exception: Cellulosic fiber loose-fill insulation shall not be required to be tested in accordance with CAN/ULC S102.2, provided that such insulation complies with the requirements of Sections R302.10.1 and R302.10.3.

R302.10.3 Cellulosic fiber loose-fill insulation. Cellulosic fiber loose-fill insulation shall comply with CPSC 16 CFR, Parts 1209 and 1404. Each package of such insulating material shall be clearly *labeled* in accordance with CPSC 16 CFR, Parts 1209 and 1404.

R302.10.4 Exposed attic insulation. Exposed insulation materials installed on *attic* floors shall have a critical radiant flux of not less than 0.12 watt per square centimeter.

R302.10.5 Testing. Tests for critical radiant flux shall be made in accordance with ASTM E970.

R302.11 Fireblocking. In combustible construction, fireblocking shall be provided to cut off both vertical and horizontal concealed draft openings and to form an effective fire barrier between stories, and between a top *story* and the roof space.

Fireblocking shall be provided in wood-framed construction in the following locations:

1. In concealed spaces of stud walls and partitions, including furred spaces and parallel rows of studs or staggered studs, as follows:
 - 1.1. Vertically at the ceiling and floor levels.
 - 1.2. Horizontally at intervals not exceeding 10 feet (3048 mm).
2. At interconnections between concealed vertical and horizontal spaces such as occur at soffits, drop ceilings and cove ceilings.
3. In concealed spaces between stair stringers at the top and bottom of the run. Enclosed spaces under stairs shall comply with Section R302.7.
4. At openings around vents, pipes, ducts, cables and wires at ceiling and floor level, with an *approved* material to resist the free passage of flame and products of combustion. The material filling this annular space shall not be required to meet the ASTM E136 requirements.
5. For the fireblocking of chimneys and fireplaces, see Section R1003.19.
6. Fireblocking of cornices of a two-family *dwelling* is required at the line of *dwelling unit* separation.

R302.11.1 Fireblocking materials. Except as provided in Section R302.11, Item 4, fireblocking shall consist of the following materials.

1. Two-inch (51 mm) nominal lumber.
2. Two thicknesses of 1-inch (25.4 mm) nominal lumber with broken lap joints.
3. One thickness of 23/32-inch (18.3 mm) wood structural panels with joints backed by 23/32-inch (18.3 mm) wood structural panels.
4. One thickness of 3/4-inch (19.1 mm) particleboard with joints backed by 3/4-inch (19.1 mm) particleboard.
5. One-half-inch (12.7 mm) gypsum board.
6. One-quarter-inch (6.4 mm) cement-based millboard.
7. Batts or blankets of mineral wool or glass fiber or other *approved* materials installed in such a manner as to be securely retained in place.
8. Cellulose insulation installed as tested in accordance with ASTM E119 or UL 263, for the specific application.

R302.11.1.1 Batts or blankets of mineral or glass fiber. Batts or blankets of mineral or glass fiber or other *approved* nonrigid materials shall be permitted for compliance with the 10-foot (3048 mm) horizontal fireblocking in walls constructed using parallel rows of studs or staggered studs.

R302.11.1.2 Unfaced fiberglass. Unfaced fiberglass batt insulation used as fireblocking shall fill the entire cross section of the wall cavity to a height of not less than 16 inches (406 mm) measured vertically. Where piping, conduit or similar obstructions are encountered, the insulation shall be packed tightly around the obstruction.

R302.11.1.3 Loose-fill insulation material. Loose-fill insulation material shall not be used as a fireblock unless specifically tested in the form and manner intended for use to demonstrate its ability to remain in place and to retard the spread of fire and hot gases.

R302.11.2 Fireblocking integrity. The integrity of fireblocks shall be maintained.

R302.12 Draftstopping. In combustible construction where there is usable space both above and below the concealed space of a floor-ceiling assembly, draftstops shall be installed so that the area of the concealed space does not exceed 1,000 square feet (92.9 m²). Draftstopping shall divide the concealed space into approximately equal areas. Where the assembly is enclosed by a floor membrane above and a ceiling membrane below, draftstopping shall be provided in floor-ceiling assemblies under the following circumstances:

1. Ceiling is suspended under the floor framing.
2. Floor framing is constructed of truss-type open-web or perforated members.

R302.12.1 Materials. Draftstopping materials shall be not less than 1/2-inch (12.7 mm) gypsum board, 3/8-inch (9.5 mm) wood structural panels or other *approved* materials adequately supported. Draftstopping shall be installed parallel to the floor framing members unless otherwise *approved* by the *building official*. The integrity of the draftstops shall be maintained.

[W] R302.13 Fire protection of floors. Floor assemblies that are not required elsewhere in this code to be fire-resistance rated, shall be provided with a 1/2-inch (12.7 mm) gypsum wallboard membrane, 5/8-inch (16 mm) wood structural panel membrane, or equivalent on the underside of the floor framing member. Penetrations or openings for ducts, vents, electrical outlets, lighting, devices, luminaires, wires, speakers, drainage, piping and similar openings or penetrations shall be permitted.

Exceptions:

1. Floor assemblies located directly over a space protected by an automatic sprinkler system in accordance with ~~((Section P2904))~~ Appendix U, NFPA 13D, or other approved equivalent sprinkler system.
2. Floor assemblies located directly over a crawl space not intended for storage or ~~((for the installation of))~~ fuel-fired ~~((or electric-powered heating))~~ appliances.
3. Portions of floor assemblies shall be permitted to be unprotected where complying with the following:
 - 3.1. The aggregate area of the unprotected portions does not exceed 80 square feet (7.4 m²) per story.
 - 3.2. Fireblocking in accordance with Section R302.11.1 is installed along the perimeter of the unprotected portion to separate the unprotected portion from the remainder of the floor assembly.
4. Wood floor assemblies using dimension lumber or structural composite lumber with a cross sectional area equal to or greater than 2-inch by 10-inch (50.8 mm by 254 mm) nominal dimension, or other approved floor assemblies demonstrating equivalent fire performance.

[S] R302.14 Combustible insulation clearance. Combustible insulation shall be separated not less than 3 inches (76 mm) from recessed luminaires, fan motors and other heat-producing devices.

Exception: Where heat-producing devices are *listed* for lesser clearances, combustible insulation complying with 3the listing requirements shall be separated in accordance with the conditions stipulated in the listing.

Recessed luminaires installed in the *building thermal envelope* shall meet the requirements of ~~((Section N1102.4.5 of this code))~~ the *Seattle Energy Code*.

SECTION R303 LIGHT, VENTILATION AND HEATING

[W] R303.1 ~~((Habitable rooms))~~ Natural light. ~~((Habitable))~~ All habitable rooms shall have an aggregate glazing area of not less than 8 percent of the floor area of such rooms. ~~((Natural ventilation shall be through windows, skylights, doors, louvers or other approved openings to the outdoor air. Such openings shall be provided with ready access or shall otherwise be readily controllable by the building occupants. The openable area to the outdoors shall be not less than 4 percent of the floor area being ventilated.))~~

~~((Exceptions))~~ Exception:

- ~~((1. The glazed areas need not be openable where the opening is not required by Section R310 and a whole-house mechanical ventilation system is installed in accordance with Section M1505.))~~
2. The glazed areas need not be installed in rooms where ~~((Exception 1 is satisfied and))~~ artificial light is provided that is capable of producing an average illumination of 6 footcandles (65 lux) over the area of the room at a height of 30 inches (762 mm) above the floor level.
- ~~((3. Use of sunroom and patio covers, as defined in Section R202, shall be permitted for natural ventilation if in excess of 40 percent of the exterior sunroom walls are open, or are enclosed only by insect screening.))~~

[W] R303.2 Adjoining rooms. For the purpose of determining light ~~((and ventilation))~~ requirements, rooms shall be considered to be a portion of an adjoining room where not less than one-half of the area of the common wall is open and unobstructed and provides an opening of not less than one-tenth of the floor area of the interior room and not less than 25 square feet (2.3 m²).

Exception: Openings required for light ~~((or ventilation))~~ shall be permitted to open into a sunroom with thermal isolation or a patio cover, provided that there is an openable area between the adjoining room and the sunroom or patio cover of not less than one-tenth of the floor area of the interior room and not less than 20 square feet (2 m²). ~~((The minimum openable area to the outdoors shall be based on the total floor area being ventilated.))~~

[W] ~~((R303.3 Bathrooms.~~ Bathrooms, water closet compartments and other similar rooms shall be provided with aggregate glazing area in windows of not less than 3 square feet (0.3 m²), one half of which shall be openable.

Exception: The glazed areas shall not be required where artificial light and a local exhaust system are provided. The minimum local exhaust rates shall be determined in accordance with Section M1505. Exhaust air from the space shall be exhausted directly to the outdoors.)

R303.4 Mechanical ventilation. Where the air infiltration rate of a *dwelling unit* is 5 air changes per hour or less where tested with a blower door at a pressure of 0.2 inch w.c (50 Pa) in accordance with Section N1102.4.1.2, the *dwelling unit* shall be provided with whole house mechanical ventilation in accordance with Section M1505.4.)

[W] R303.4 Minimum ventilation performance. *Dwelling units* shall be equipped with *local exhaust* and *whole house ventilation systems* designed and installed as specified in Section M1505.4.

Exception: Additions with less than 500 square feet of conditioned floor area are exempt from the requirements for *whole house mechanical ventilation systems*.

R303.5 Opening location. Outdoor intake and exhaust openings shall be located in accordance with Sections R303.5.1 and R303.5.2.

[W] R303.5.1 Intake openings. Mechanical and gravity outdoor air intake openings shall be located not less than 10 feet (3048 mm) from any hazardous or noxious contaminant, such as vents, chimneys, plumbing vents, streets, alleys, parking lots and loading docks, except as otherwise specified in this code.

For the purpose of this section, the exhaust from *dwelling unit* toilet rooms, bathrooms and kitchens shall not be considered as hazardous or noxious.

Exceptions:

1. The 10-foot (3048 mm) separation is not required where the intake opening is located 3 feet (914 mm) or greater below the contaminant source.
2. Vents and chimneys serving fuel-burning appliances shall be terminated in accordance with the applicable provisions of Chapters 18 and 24.
3. Clothes dryer exhaust ducts shall be terminated in accordance with Section M1502.3.

[W] R303.5.2 Exhaust openings. Exhaust air shall not be directed onto walkways. All exhaust ducts shall terminate outside the building. Terminal elements shall have at least the equivalent net free area of the ductwork.

[W] R303.5.2.1 Exhaust ducts. Exhaust ducts shall be equipped with back-draft dampers. All exhaust ducts in unconditioned spaces shall be insulated to a minimum of R-4.

R303.6 Outside opening protection. Air exhaust and intake openings that terminate outdoors shall be protected with corrosion-resistant screens, louvers or grilles having an opening size of not less than 1/4 inch (6 mm) and a maximum opening size of 1/2 inch (13 mm), in any dimension. Openings shall be protected against local weather conditions. Outdoor air exhaust and intake openings shall meet the provisions for *exterior wall* opening protectives in accordance with this code.

[W] R303.7 Interior stairway illumination. Interior stairways shall be provided with an artificial light source to illuminate the landings and treads. Stairway illumination shall receive power from the building wiring. The light source shall be capable of illuminating treads and landings to levels of not less than 1 foot-candle (11 lux) as measured at the center of treads and landings. There shall be a wall switch at each floor level to control the light source where the stairway has six or more risers.

Exception: A switch is not required where remote, central or automatic control of lighting is provided.

[W] R303.8 Exterior stairway illumination. Exterior stairways shall be provided with an artificial light source located at the top landing of the stairway. Stairway illumination shall receive power from the building wiring. Exterior stairways providing access to a *basement* from the outdoor *grade* level shall be provided with an artificial light source located at the bottom landing of the stairway.

[W] R303.9 Required glazed openings. Required glazed openings shall open directly onto a street or public alley, or a *yard* or court located on the same *lot* as the building.

Exceptions:

1. Required glazed openings that face into a roofed porch where the porch abuts a street, *yard* or court ~~((and))~~ are permitted where the longer side of the porch is not less than 65 percent unobstructed and the ceiling height is not less than 7 feet (2134 mm).
2. Eave projections shall not be considered as obstructing the clear open space of a *yard* or court.
3. Required glazed openings that face into the area under a deck, balcony, bay or floor cantilever are permitted where ~~((a clear vertical space not less than 36 inches (914 mm) in height))~~ an unobstructed pathway of not less than 36 inches (914 mm) in height, 36 inches (914 mm) in width, and no greater than 60 inches (1524 mm) in length is provided and opens to a yard or court. The pathway shall be measured from the exterior face of the glazed opening, or if the glazed opening is in a window well, at the window well wall furthest from the exterior face of the glazed opening.

R303.9.1 Sunroom additions. Required glazed openings shall be permitted to open into sunroom *additions* or patio covers that abut a street, *yard* or court if in excess of 40 percent of the exterior sunroom walls are open, or are enclosed only by insect screening, and the ceiling height of the sunroom is not less than 7 feet (2134 mm).

[W][S] R303.10 Required heating. ~~(Where the winter design temperature in Table R301.2(1) is below 60°F (16°C), every)~~ Every *dwelling unit* shall be provided with heating facilities capable of maintaining a minimum room temperature of not less than 68°F (20°C) at a point 3 feet (914 mm) above the floor and 2 feet (610 mm) from exterior walls in habitable rooms, baths and toilet rooms at the design temperature as specified in Table R301.2(1). The installation of one or more portable space heaters shall not be used to achieve compliance with this section.

Exception: Unheated recreational tents or yurts not exceeding 500 square feet provided they are not occupied as a permanent dwelling.

Interpretation R303.10: Accessory *dwelling units* shall be provided with heating controls separate from the primary *dwelling unit*.

[W] R303.10.1 Definitions. For the purposes of this section only, the following definitions apply.

DESIGNATED AREAS. Those areas designated by a county to be an urban growth area in chapter 36.70A RCW and those areas designated by the U.S. Environmental Protection Agency as being in nonattainment for particulate matter.

SUBSTANTIALLY REMODELED. Any *alteration* or restoration of a building exceeding 60 percent of the appraised value of such building within a 12 month period. For the purpose of this section, the appraised value is the estimated cost to replace the building and structure in kind, based on current replacement costs.

[W] R303.10.2 Primary heating source. Primary heating sources in all new and substantially remodeled buildings in designated areas shall not be dependent upon wood stoves.

[W] R303.10.3 Solid fuel burning devices. No new or used solid fuel burning device shall be installed in new or existing buildings unless such device is United States Environmental Protection Agency certified or exempt from certification by the United States Environmental Protection Agency and conforms with RCW 70.94.011, 70.94.450, 70.94.453 and 70.94.457.

Exceptions:

1. Wood cook stoves.
2. Antique wood heaters manufactured prior to 1940.

SECTION R304 MINIMUM ROOM AREAS

R304.1 Minimum area. Habitable rooms shall have a floor area of not less than 70 square feet (6.5 m²).

Exception: Kitchens.

R304.2 Minimum dimensions. Habitable rooms shall be not less than 7 feet (2134 mm) in any horizontal dimension.

Exception: Kitchens.

R304.3 Height effect on room area. Portions of a room with a sloping ceiling measuring less than 5 feet (1524 mm) or a furred ceiling measuring less than 7 feet (2134 mm) from the finished floor to the finished ceiling shall not be considered as contributing to the minimum required habitable area for that room.

SECTION R305 CEILING HEIGHT

R305.1 Minimum height. *Habitable space*, hallways and portions of *basements* containing these spaces shall have a ceiling height of not less than 7 feet (2134 mm). Bathrooms, toilet rooms and laundry rooms shall have a ceiling height of not less than 6 feet 8 inches (2032 mm).

Exceptions:

1. For rooms with sloped ceilings, the required floor area of the room shall have a ceiling height of not less than 5 feet (1524 mm) and not less than 50 percent of the required floor area shall have a ceiling height of not less than 7 feet (2134 mm).
2. The ceiling height above bathroom and toilet room fixtures shall be such that the fixture is capable of being used for its intended purpose. A shower or tub equipped with a showerhead shall have a ceiling height of not less than 6 feet 8 inches (2032 mm) above an area of not less than 30 inches (762 mm) by 30 inches (762 mm) at the showerhead.

BUILDING PLANNING

3. Beams, girders, ducts or other obstructions in *basements* containing *habitable space* shall be permitted to project to within 6 feet 4 inches (1931 mm) of the finished floor.

R305.1.1 Basements. Portions of *basements* that do not contain *habitable space* or hallways shall have a ceiling height of not less than 6 feet 8 inches (2032 mm).

Exception: At beams, girders, ducts or other obstructions, the ceiling height shall be not less than 6 feet 4 inches (1931 mm) from the finished floor.

SECTION R306 SANITATION

R306.1 Toilet facilities. Every *dwelling* unit shall be provided with a water closet, lavatory, and a bathtub or shower.

R306.2 Kitchen. Each *dwelling* unit shall be provided with a kitchen area and every kitchen area shall be provided with a sink.

R306.3 Sewage disposal. Plumbing fixtures shall be connected to a sanitary sewer or to an *approved* private sewage disposal system.

R306.4 Water supply to fixtures. Plumbing fixtures shall be connected to an *approved* water supply. Kitchen sinks, lavatories, bathtubs, showers, bidets, laundry tubs and washing machine outlets shall be provided with hot and cold water.

SECTION R307 TOILET, BATH AND SHOWER SPACES

[W] **R307.1 Space required.** Fixtures shall be spaced in accordance with Figure R307.1, and in accordance with the requirements of ((Section P2705.1)) Uniform Plumbing Code Section 402.5.

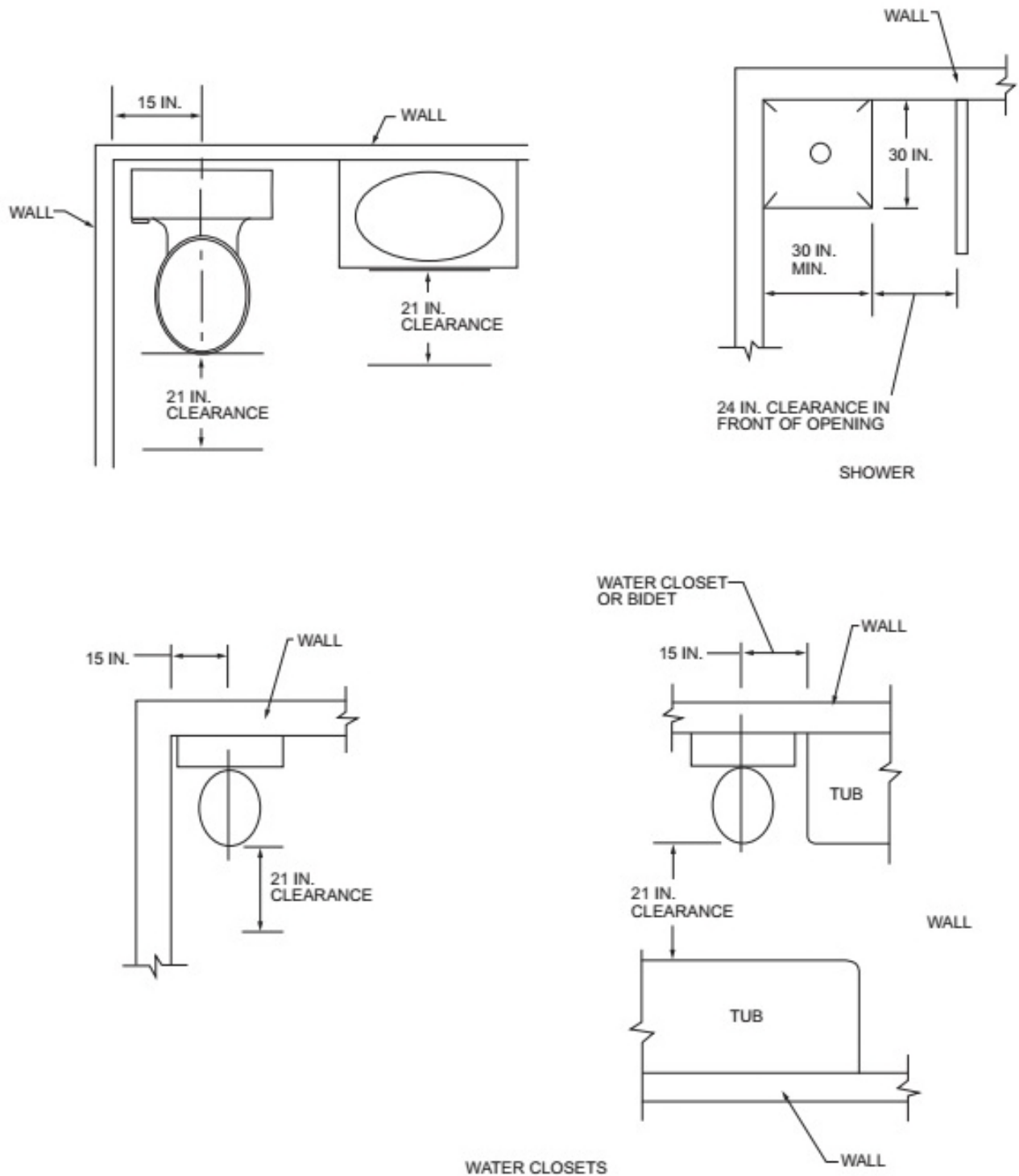

For SI: 1 inch = 25.4 mm.

FIGURE R307.1
MINIMUM FIXTURE CLEARANCES

R307.2 Bathtub and shower spaces. Bathtub and shower floors and walls above bathtubs with installed shower heads and in shower compartments shall be finished with a nonabsorbent surface. Such wall surfaces shall extend to a height of not less than 6 feet (1829 mm) above the floor.

**SECTION R308
GLAZING**

R308.1 Identification. Except as indicated in Section R308.1.1 each pane of glazing installed in hazardous locations as defined in Section R308.4 shall be provided with a manufacturer’s designation specifying who applied the designation, the type of glass and the safety glazing standard with which it complies, and that is visible in the final installation. The designation shall be acid etched, sandblasted, ceramic-fired, laser etched, embossed, or be of a type that once applied cannot be removed without being destroyed. A *label* shall be permitted in lieu of the manufacturer’s designation.

Exceptions:

1. For other than tempered glass, manufacturer’s designations are not required provided that the *building official* approves the use of a certificate, affidavit or other evidence confirming compliance with this code.
2. Tempered spandrel glass is permitted to be identified by the manufacturer with a removable paper designation.

R308.1.1 Identification of multiple assemblies. Multipane assemblies having individual panes not exceeding 1 square foot (0.09 m²) in exposed area shall have not less than one pane in the assembly identified in accordance with Section R308.1. Other panes in the assembly shall be *labeled* “CPSC 16 CFR 1201” or “ANSI Z97.1” as appropriate.

R308.2 Louvered windows or jalousies. Regular, float, wired or patterned glass in jalousies and louvered windows shall be not less than nominal 3/16 inch (5 mm) thick and not more than 48 inches (1219 mm) in length. Exposed glass edges shall be smooth.

R308.2.1 Wired glass prohibited. Wired glass with wire exposed on longitudinal edges shall not be used in jalousies or louvered windows.

R308.3 Human impact loads. Individual glazed areas, including glass mirrors in hazardous locations such as those indicated as defined in Section R308.4, shall pass the test requirements of Section R308.3.1.

Exceptions:

1. Louvered windows and jalousies shall comply with Section R308.2.
2. Mirrors and other glass panels mounted or hung on a surface that provides a continuous backing support.
3. Glass unit masonry complying with Section R607.

R308.3.1 Impact test. Where required by other sections of the code, glazing shall be tested in accordance with CPSC 16 CFR 1201. Glazing shall comply with the test criteria for Category II unless otherwise indicated in Table R308.3.1(1).

Exception: Glazing not in doors or enclosures for hot tubs, whirlpools, saunas, steam rooms, bathtubs and showers shall be permitted to be tested in accordance with ANSI Z97.1. Glazing shall comply with the test criteria for Class A unless otherwise indicated in Table R308.3.1(2).

**TABLE R308.3.1(1)
MINIMUM CATEGORY CLASSIFICATION OF GLAZING USING CPSC 16 CFR 1201**

EXPOSED SURFACE AREA OF ONE SIDE OF ONE LITE	GLAZING IN STORM OR COMBINATION DOORS (Category Class)	GLAZING IN DOORS (Category Class)	GLAZED PANELS REGULATED BY SECTION R308.4.3 (Category Class)	GLAZED PANELS REGULATED BY SECTION R308.4.2 (Category Class)	GLAZING IN DOORS AND ENCLOSURES REGULATED BY SECTION 308.4.5 (Category Class)	SLIDING GLASS DOORS PATIO TYPE (Category Class)
9 square feet or less	I	I	NR	I	II	II
More than 9 square feet	II	II	II	II	II	II

For SI: 1 square foot = 0.0929 m².
NR = No Requirement.

**TABLE R308.3.1(2)
MINIMUM CATEGORY CLASSIFICATION OF GLAZING USING ANSI Z97.1**

EXPOSED SURFACE AREA OF ONE SIDE OF ONE LITE	GLAZED PANELS REGULATED BY SECTION R308.4.3 (Category Class)	GLAZED PANELS REGULATED BY SECTION R308.4.2 (Category Class)	DOORS AND ENCLOSURES REGULATED BY SECTION R308.4.5 ^a (Category Class)
9 square feet or less	No requirement	B	A
More than 9 square feet	A	A	A

For SI: 1 square foot = 0.0929 m².
a. Use is permitted only by the exception to Section R308.3.1.

R308.4 Hazardous locations. The locations specified in Sections R308.4.1 through R308.4.7 shall be considered to be specific hazardous locations for the purposes of glazing.

R308.4.1 Glazing in doors. Glazing in fixed and operable panels of swinging, sliding and bifold doors shall be considered to be a hazardous location.

Exceptions:

1. Glazed openings of a size through which a 3-inch-diameter (76 mm) sphere is unable to pass.
2. Decorative glazing.

R308.4.2 Glazing adjacent to doors. Glazing in an individual fixed or operable panel adjacent to a door shall be considered to be a hazardous location where the bottom exposed edge of the glazing is less than 60 inches (1524 mm) above the floor or walking surface and it meets either of the following conditions:

1. Where the glazing is within 24 inches (610 mm) of either side of the door in the plane of the door in a closed position.
2. Where the glazing is on a wall less than 180 degrees (3.14 rad) from the plane of the door in a closed position and within 24 inches (610 mm) of the hinge side of an in-swinging door.

Exceptions:

1. Decorative glazing.
2. Where there is an intervening wall or other permanent barrier between the door and the glazing.
3. Where access through the door is to a closet or storage area 3 feet (914 mm) or less in depth. Glazing in this application shall comply with Section R308.4.3.
4. Glazing that is adjacent to the fixed panel of patio doors.

R308.4.3 Glazing in windows. Glazing in an individual fixed or operable panel that meets all of the following conditions shall be considered to be a hazardous location:

1. The exposed area of an individual pane is larger than 9 square feet (0.836 m²).
2. The bottom edge of the glazing is less than 18 inches (457 mm) above the floor.
3. The top edge of the glazing is more than 36 inches (914 mm) above the floor.
4. One or more walking surfaces are within 36 inches (914 mm), measured horizontally and in a straight line, of the glazing.

Exceptions:

1. Decorative glazing.
2. Where glazing is adjacent to a walking surface and a horizontal rail is installed 34 to 38 inches (864 to 965 mm) above the walking surface. The rail shall be capable of withstanding a horizontal load of 50 pounds per linear foot (730 N/m) without contacting the glass and have a cross-sectional height of not less than 1-1/2 inches (38 mm).
3. Outboard panes in insulating glass units and other multiple glazed panels where the bottom edge of the glass is 25 feet (7620 mm) or more above *grade*, a roof, walking surfaces or other horizontal [within 45 degrees (0.79 rad) of horizontal] surface adjacent to the glass exterior.

R308.4.4 Glazing in guards and railings. Glazing in *guards* and railings, including structural baluster panels and nonstructural in-fill panels, regardless of area or height above a walking surface shall be considered to be a hazardous location.

R308.4.4.1 Structural glass baluster panels. Guards with structural glass baluster panels shall be installed with an attached top rail or handrail. The top rail or handrail shall be supported by not less than three glass baluster panels, or shall be otherwise supported to remain in place should one glass baluster panel fail.

Exception: An attached top rail or handrail is not required where the glass baluster panels are laminated glass with two or more glass plies of equal thickness and of the same glass type.

R308.4.5 Glazing and wet surfaces. Glazing in walls, enclosures or fences containing or facing hot tubs, spas, whirlpools, saunas, steam rooms, bathtubs, showers and indoor or outdoor swimming pools where the bottom exposed edge of the glazing is less than 60 inches (1524 mm) measured vertically above any standing or walking surface shall be considered to be a hazardous location. This shall apply to single glazing and each pane in multiple glazing.

Exception: Glazing that is more than 60 inches (1524 mm), measured horizontally and in a straight line, from the water's edge of a bathtub, hot tub, spa, whirlpool or swimming pool or from the edge of a shower, sauna or steam room.

R308.4.6 Glazing adjacent to stairs and ramps. Glazing where the bottom exposed edge of the glazing is less than 36 inches (914 mm) above the plane of the adjacent walking surface of stairways, landings between flights of stairs and ramps shall be considered to be a hazardous location.

Exceptions:

1. Where glazing is adjacent to a walking surface and a horizontal rail is installed at 34 to 38 inches (864 to 965 mm) above the walking surface. The rail shall be capable of withstanding a horizontal load of 50 pounds per linear foot (730 N/m) without contacting the glass and have a cross-sectional height of not less than 1-1/2 inches (38 mm).
2. Glazing 36 inches (914 mm) or more measured horizontally from the walking surface.

R308.4.7 Glazing adjacent to the bottom stair landing. Glazing adjacent to the landing at the bottom of a stairway where the glazing is less than 36 inches (914 mm) above the landing and within a 60-inch (1524 mm) horizontal arc less than 180 degrees (3.14 rad) from the bottom tread nosing shall be considered to be a hazardous location. (See Figure R308.4.7.)

Exception: Where the glazing is protected by a *guard* complying with Section R312 and the plane of the glass is more than 18 inches (457 mm) from the *guard*.

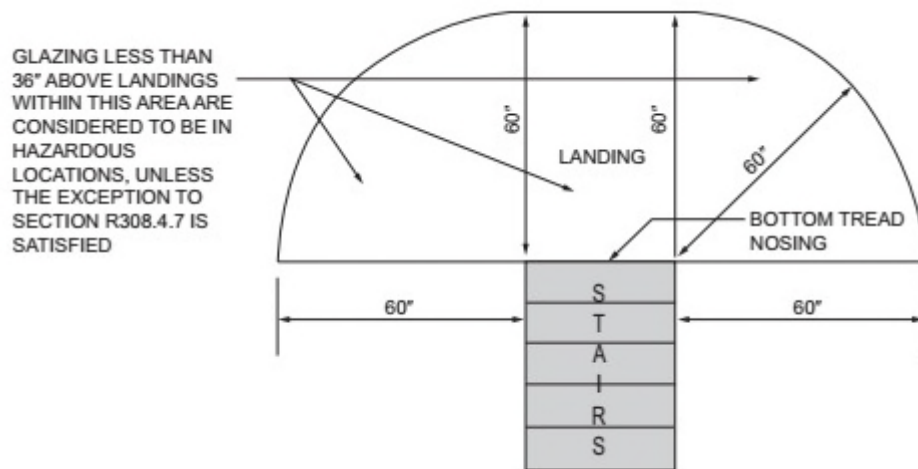

For SI: 1 inch = 25.4 mm.

FIGURE R308.4.7
HAZARDOUS GLAZING LOCATIONS AT BOTTOM STAIR LANDINGS

R308.5 Site-built windows. Site-built windows shall comply with Section 2404 of the *International Building Code*.

R308.6 Skylights and sloped glazing. Skylights and sloped glazing shall comply with the following sections.

R308.6.1 Definitions. The following terms are defined in Chapter 2:

SKYLIGHT, UNIT.

SKYLIGHTS AND SLOPED GLAZING.

TUBULAR DAYLIGHTING DEVICE (TDD).

R308.6.2 Materials. Glazing materials shall be limited to the following:

1. Laminated glass with not less than a 0.015-inch (0.38 mm) polyvinyl butyral interlayer for glass panes 16 square feet (1.5 m²) or less in area located such that the highest point of the glass is not more than 12 feet (3658 mm) above a walking surface; for higher or larger sizes, the interlayer thickness shall be not less than 0.030 inch (0.76 mm).
2. Fully tempered glass.
3. Heat-strengthened glass.
4. Wired glass.
5. *Approved* rigid plastics.

R308.6.3 Screens, general. For fully tempered or heat-strengthened glass, a retaining screen meeting the requirements of Section R308.6.7 shall be installed below the glass, except for fully tempered glass that meets either condition listed in Section R308.6.5.

R308.6.4 Screens with multiple glazing. Where the inboard pane is fully tempered, heat-strengthened or wired glass, a retaining screen meeting the requirements of Section R308.6.7 shall be installed below the glass, except for either condition listed in Section R308.6.5. Other panes in the multiple glazing shall be of any type listed in Section R308.6.2.

R308.6.5 Screens not required. Screens shall not be required where fully tempered glass is used as single glazing or the inboard pane in multiple glazing and either of the following conditions are met:

1. The glass area is 16 square feet (1.49 m²) or less; the highest point of glass is not more than 12 feet (3658 mm) above a walking surface; the nominal glass thickness is not more than 3/16 inch (4.8 mm); and (for multiple glazing only) the other pane or panes are fully tempered, laminated or wired glass.
2. The glass area is greater than 16 square feet (1.49 m²); the glass is sloped 30 degrees (0.52 rad) or less from vertical; and the highest point of glass is not more than 10 feet (3048 mm) above a walking surface.

R308.6.6 Glass in greenhouses. Any glazing material is permitted to be installed without screening in the sloped areas of greenhouses, provided that the greenhouse height at the ridge does not exceed 20 feet (6096 mm) above *grade*.

R308.6.7 Screen characteristics. The screen and its fastenings shall be capable of supporting twice the weight of the glazing, be firmly and substantially fastened to the framing members, and have a mesh opening of not more than 1 inch by 1 inch (25 mm by 25 mm).

R308.6.8 Curbs for skylights. Unit skylights installed in a roof with a pitch of less than three units vertical in 12 units horizontal (25-percent slope) shall be mounted on a curb extending not less than 4 inches (102 mm) above the plane of the roof, unless otherwise specified in the manufacturer's installation instructions.

R308.6.9 Testing and labeling. Unit skylights and tubular daylighting devices shall be tested by an *approved* independent laboratory, and bear a *label* identifying manufacturer, performance grade rating and *approved* inspection agency to indicate compliance with the requirements of AAMA/WDMA/CSA 101/I.S.2/A440.

R308.6.9.1 Comparative analysis for glass-glazed unit skylights. Structural wind load design pressures for glass-glazed unit skylights different than the size tested in accordance with Section R308.6.9 shall be permitted to be different than the design value of the tested unit where determined in accordance with one of the following comparative analysis methods:

1. Structural wind load design pressures for glass-glazed unit skylights smaller than the size tested in accordance with Section R308.6.9 shall be permitted to be higher than the design value of the tested unit provided that such higher pressures are determined by accepted engineering analysis. Components of the smaller unit shall be the same as those of the tested unit. Such calculated design pressures shall be validated by an additional test of the glass-glazed unit skylight having the highest allowable design pressure.
2. In accordance with WDMA I.S. 11.

SECTION R309 GARAGES AND CARPORTS

R309.1 Floor surface. Garage floor surfaces shall be of *approved* noncombustible material.

The area of floor used for parking of automobiles or other vehicles shall be sloped to facilitate the movement of liquids to a drain or toward the main vehicle entry doorway.

R309.2 Carports. Carports shall be open on not less than two sides. Carport floor surfaces shall be of *approved* noncombustible material. Carports not open on two or more sides shall be considered to be a garage and shall comply with the provisions of this section for garages.

The area of floor used for parking of automobiles or other vehicles shall be sloped to facilitate the movement of liquids to a drain or toward the main vehicle entry doorway.

Exception: Asphalt surfaces shall be permitted at ground level in carports.

R309.3 Flood hazard areas. For buildings located in flood hazard areas as established by Table R301.2(1), garage floors shall be one of the following:

1. Elevated to or above the design flood elevation as determined in accordance with Section R322.
2. Located below the design flood elevation provided that the floors are at or above *grade* on not less than one side, are used solely for parking, building access or storage, meet the requirements of Section R322 and are otherwise constructed in accordance with this code.

R309.4 Automatic garage door openers. Automatic garage door openers, if provided, shall be *listed* and *labeled* in accordance with UL 325.

~~[S] ((**R309.5 Fire sprinklers.** Private garages shall be protected by fire sprinklers where the garage wall has been designed based on Table R302.1(2), Note a. Sprinklers in garages shall be connected to an automatic sprinkler system that complies with Section P2904. Garage sprinklers shall be residential sprinklers or quick response sprinklers, designed to provide a density of 0.05 gpm/ft². Garage doors shall not be considered obstructions with respect to sprinkler placement.))~~

SECTION R310 EMERGENCY ESCAPE AND RESCUE OPENINGS

[W] **R310.1 Emergency escape and rescue opening required.** *Basements, habitable attics* and every sleeping room shall have not less than one operable emergency escape and rescue opening. Where *basements* contain one or more sleeping rooms, an emergency escape and rescue opening shall be required in each sleeping room. Emergency escape and rescue openings shall open directly into a public way, or to a *yard* or court providing an unobstructed path with a width of not less than 36 inches (914 mm) that opens to a public way.

Exceptions:

1. Storm shelters and *basements* used only to house mechanical *equipment* not exceeding a total floor area of 200 square feet (18.58 m²).
2. Where the *dwelling unit* or *townhouse unit* is equipped with an automatic sprinkler system installed in accordance with Section P2904, sleeping rooms in basements shall not be required to have emergency escape and rescue openings provided that the basement has one of the following:
 - 2.1. One means of egress complying with Section R311 and one emergency escape and rescue opening.
 - 2.2. Two means of egress complying with Section R311.

[W] **R310.1.1 Operational constraints and opening control devices.** Emergency escape and rescue openings shall be operational from the inside of the room without the use of keys, tools or special knowledge. Window opening control devices on windows serving as a required emergency escape and rescue opening shall be not more than 70 inches (177.8 cm) above the finished floor and shall comply with ASTM F2090.

R310.2 Emergency escape and rescue openings. Emergency escape and rescue openings shall have minimum dimensions as specified in this section.

R310.2.1 Minimum opening area. Emergency escape and rescue openings shall have a net clear opening of not less than 5.7 square feet (0.530 m²). The net clear opening dimensions required by this section shall be obtained by the normal operation of the emergency escape and rescue opening from the inside. The net clear height of the opening shall be not less than 24 inches (610 mm) and the net clear width shall be not less than 20 inches (508 mm).

Exception: *Grade* floor openings or below-*grade* openings shall have a net clear opening area of not less than 5 square feet (0.465 m²).

R310.2.2 Window sill height. Where a window is provided as the emergency escape and rescue opening, it shall have a sill height of not more than 44 inches (1118 mm) above the floor; where the sill height is below *grade*, it shall be provided with a window well in accordance with Section R310.2.3.

R310.2.3 Window wells. The horizontal area of the window well shall be not less than 9 square feet (0.9 m²), with a horizontal projection and width of not less than 36 inches (914 mm). The area of the window well shall allow the emergency escape and rescue opening to be fully opened.

Exception: The ladder or steps required by Section R310.2.3.1 shall be permitted to encroach not more than 6 inches (152 mm) into the required dimensions of the window well.

R310.2.3.1 Ladder and steps. Window wells with a vertical depth greater than 44 inches (1118 mm) shall be equipped with a permanently affixed ladder or steps usable with the window in the fully open position. Ladders or steps required by this section shall not be required to comply with Section R311.7. Ladders or rungs shall have an inside width of not less than 12 inches (305 mm), shall project not less than 3 inches (76 mm) from the wall and shall be spaced not more than 18 inches (457 mm) on center vertically for the full height of the window well.

R310.2.3.2 Drainage. Window wells shall be designed for proper drainage by connecting to the building's foundation drainage system required by Section R405.1 or by an approved alternative method.

Exception: A drainage system for window wells is not required where the foundation is on well-drained soil or sand-gravel mixture soils in accordance with the United Soil Classification System, Group I Soils, as detailed in Table R405.1.

[W] **R310.2.4 Emergency escape and rescue openings under decks and porches.** Emergency escape and rescue openings installed under decks and porches shall be fully openable and ~~((provide a path))~~ provided with an unobstructed pathway of not less than 36 inches (914 mm) in height, 36 inches (914 mm) in width, and no greater than 60 inches (1524 mm) in length that opens to a yard or court. The pathway shall be measured from the exterior face of the glazed opening, or if the glazed opening is in a window well, at the window well wall furthest from the exterior face of the glazed opening.

R310.2.5 Replacement windows. Replacement windows installed in buildings meeting the scope of this code shall be exempt from the maximum sill height requirements of Section R310.2.2 and the requirements of Section R310.2.1, provided that the replacement window meets the following conditions:

1. The replacement window is the manufacturer's largest standard size window that will fit within the existing frame or existing rough opening. The replacement window is of the same operating style as the existing window or a style that provides for an equal or greater window opening area than the existing window.
2. The replacement window is not part of a change of occupancy.

R310.3 Emergency escape and rescue doors. Where a door is provided as the required emergency escape and rescue opening, it shall be a side-hinged door or a slider. Where the opening is below the adjacent grade, it shall be provided with an area well.

R310.3.1 Minimum door opening size. The minimum net clear height opening for any door that serves as an emergency and escape rescue opening shall be in accordance with Section R310.2.1.

R310.3.2 Area wells. Area wells shall have a width of not less than 36 inches (914 mm). The area well shall be sized to allow the emergency escape and rescue door to be fully opened.

R310.3.2.1 Ladder and steps. Area wells with a vertical depth greater than 44 inches (1118 mm) shall be equipped with a permanently affixed ladder or steps usable with the door in the fully open position. Ladders or steps required by this section shall not be required to comply with Section R311.7. Ladders or rungs shall have an inside width of not less than 12 inches (305 mm), shall project not less than 3 inches (76 mm) from the wall and shall be spaced not more than 18 inches (457 mm) on center vertically for the full height of the exterior stairwell.

R310.3.2.2 Drainage. Area wells shall be designed for proper drainage by connecting to the building's foundation drainage system required by Section R405.1 or by an *approved* alternative method.

Exception: A drainage system for area wells is not required where the foundation is on well-drained soil or sand-gravel mixture soils in accordance with the United Soil Classification System, Group I Soils, as detailed in Table R405.1.

R310.4 Bars, grilles, covers and screens. Where bars, grilles, covers, screens or similar devices are placed over emergency escape and rescue openings, area wells, or window wells, the minimum net clear opening size shall comply with Sections R310.2.1 through R310.2.3, and such devices shall be releasable or removable from the inside without the use of a key, tool, special knowledge or force greater than that required for the normal operation of the escape and rescue opening.

R310.5 Dwelling additions. Where *dwelling additions* contain sleeping rooms, an emergency escape and rescue opening shall be provided in each new sleeping room. Where *dwelling additions* have *basements*, an emergency escape and rescue opening shall be provided in the new *basement*.

Exceptions:

1. An emergency escape and rescue opening is not required in a new *basement* that contains a sleeping room with an emergency escape and rescue opening.
2. An emergency escape and rescue opening is not required in a new *basement* where there is an emergency escape and rescue opening in an existing *basement* that is *accessed* from the new *basement*.

R310.6 Alterations or repairs of existing basements. An emergency escape and rescue opening is not required where existing *basements* undergo alterations or repairs.

Exception: New sleeping rooms created in an existing *basement* shall be provided with emergency escape and rescue openings in accordance with Section R310.1.

SECTION R311 MEANS OF EGRESS

R311.1 Means of egress. *Dwellings* shall be provided with a means of egress in accordance with this section. The means of egress shall provide a continuous and unobstructed path of vertical and horizontal egress travel from all portions of the *dwelling* to the required egress door without requiring travel through a garage. The required egress door shall open directly into a public way or to a *yard* or court that opens to a public way.

R311.2 Egress door. Not less than one egress door shall be provided for each *dwelling* unit. The egress door shall be side-hinged, and shall provide a clear width of not less than 32 inches (813 mm) where measured between the face of the door and the stop, with the door open 90 degrees (1.57 rad). The clear height of the door opening shall be not less than 78 inches (1981 mm) in height measured from the top of the threshold to the bottom of the stop. Other doors shall not be required to comply with these minimum dimensions. Egress doors shall be readily openable from inside the *dwelling* without the use of a key or special knowledge or effort.

R311.3 Floors and landings at exterior doors. There shall be a landing or floor on each side of each exterior door. The width of each landing shall be not less than the door served. Landings shall have a dimension of not less than 36 inches (914 mm) measured in the direction of travel. The slope at exterior landings shall not exceed 1/4 unit vertical in 12 units horizontal (2 percent).

Exception: Exterior balconies less than 60 square feet (5.6 m²) and only *accessed* from a door are permitted to have a landing that is less than 36 inches (914 mm) measured in the direction of travel.

R311.3.1 Floor elevations at the required egress doors. Landings or finished floors at the required egress door shall be not more than 1-1/2 inches (38 mm) lower than the top of the threshold.

Exception: The landing or floor on the exterior side shall be not more than 7-3/4 inches (196 mm) below the top of the threshold provided that the door does not swing over the landing or floor.

Where exterior landings or floors serving the required egress door are not at *grade*, they shall be provided with access to *grade* by means of a ramp in accordance with Section R311.8 or a stairway in accordance with Section R311.7.

R311.3.2 Floor elevations at other exterior doors. Doors other than the required egress door shall be provided with landings or floors not more than 7-3/4 inches (196 mm) below the top of the threshold.

Exception: A top landing is not required where a stairway of not more than two risers is located on the exterior side of the door, provided that the door does not swing over the stairway.

R311.3.3 Storm and screen doors. Storm and screen doors shall be permitted to swing over exterior stairs and landings.

[W] R311.4 Vertical egress. Egress from habitable levels including habitable attics and *basements* that are not provided with an egress door in accordance with Section R311.2 shall be by a ramp in accordance with Section R311.8 or a stairway in accordance with Section R311.7.

Exception: Stairs or ladders inside an individual dwelling unit used for access to areas of 200 square feet (18.6 m²) or less, and not containing the primary bathroom or kitchen.

R311.5 Landing, deck, balcony and stair construction and attachment. Exterior landings, decks, balconies, stairs and similar facilities shall be positively anchored to the primary structure to resist both vertical and lateral forces or shall be designed to be self-supporting. Attachment shall not be accomplished by use of toenails or nails subject to withdrawal.

R311.6 Hallways. The width of a hallway shall be not less than 3 feet (914 mm).

R311.7 Stairways.

R311.7.1 Width. Stairways shall be not less than 36 inches (914 mm) in clear width at all points above the permitted handrail height and below the required headroom height. The clear width of stairways at and below the handrail height, including treads and landings, shall be not less than 31-1/2 inches (787 mm) where a handrail is installed on one side and 27 inches (698 mm) where handrails are installed on both sides.

Exception: The width of spiral stairways shall be in accordance with Section R311.7.10.1.

R311.7.2 Headroom. The headroom in stairways shall be not less than 6 feet 8 inches (2032 mm) measured vertically from the sloped line adjoining the tread nosing or from the floor surface of the landing or platform on that portion of the stairway.

Exceptions:

1. Where the nosings of treads at the side of a flight extend under the edge of a floor opening through which the stair passes, the floor opening shall not project horizontally into the required headroom more than 4-3/4 inches (121 mm).
2. The headroom for spiral stairways shall be in accordance with Section R311.7.10.1.

[W] R311.7.3 Vertical rise. A flight of stairs shall not have a vertical rise larger than (~~45-1/2 inches~~) 12 feet 7 inches (3835 mm) between floor levels or landings.

R311.7.4 Walkline. The walkline across winder treads and landings shall be concentric to the turn and parallel to the direction of travel entering and exiting the turn. The walkline shall be located 12 inches (305 mm) from the inside of the turn. The 12-inch (305 mm) dimension shall be measured from the widest point of the clear stair width at the walking surface. Where winders are adjacent within a flight, the point of the widest clear stair width of the adjacent winders shall be used.

R311.7.5 Stair treads and risers. Stair treads and risers shall meet the requirements of this section. For the purposes of this section, dimensions and dimensioned surfaces shall be exclusive of carpets, rugs or runners.

R311.7.5.1 Risers. The riser height shall be not more than 7-3/4 inches (196 mm). The riser shall be measured vertically between leading edges of the adjacent treads. The greatest riser height within any flight of stairs shall not exceed the smallest by more than 3/8 inch (9.5 mm). Risers shall be vertical or sloped from the underside of the nosing of the tread above at an angle not more than 30 degrees (0.51 rad) from the vertical. At open risers, openings located more than 30 inches (762 mm), as measured vertically, to the floor or grade below shall not permit the passage of a 4-inch-diameter (102 mm) sphere.

Exceptions:

1. The opening between adjacent treads is not limited on spiral stairways.
2. The riser height of spiral stairways shall be in accordance with Section R311.7.10.1.

R311.7.5.2 Treads. The tread depth shall be not less than 10 inches (254 mm). The tread depth shall be measured horizontally between the vertical planes of the foremost projection of adjacent treads and at a right angle to the tread's leading edge. The greatest tread depth within any flight of stairs shall not exceed the smallest by more than 3/8 inch (9.5 mm).

R311.7.5.2.1 Winder treads. Winder treads shall have a tread depth of not less than 10 inches (254 mm) measured between the vertical planes of the foremost projection of adjacent treads at the intersections with the walkline. Winder treads shall have a tread depth of not less than 6 inches (152 mm) at any point within the clear width of the stair. Within any flight of stairs, the largest winder tread depth at the walkline shall not exceed the smallest winder tread by more than 3/8 inch (9.5 mm). Consistently shaped winders at the walkline shall be allowed within the same flight of stairs as rectangular treads and shall not be required to be within 3/8 inch (9.5 mm) of the rectangular tread depth.

Exception: The tread depth at spiral stairways shall be in accordance with Section R311.7.10.1.

R311.7.5.3 Nosings. Nosings at treads, landings and floors of stairways shall have a radius of curvature at the nosing not greater than 9/16 inch (14 mm) or a bevel not greater than 1/2 inch (12.7 mm). A nosing projection not less than 3/4 inch (19 mm) and not more than 1-1/4 inches (32 mm) shall be provided on stairways. The greatest nosing projection shall not exceed the smallest nosing projection by more than 3/8 inch (9.5 mm) within a stairway.

Exception: A nosing projection is not required where the tread depth is not less than 11 inches (279 mm).

R311.7.5.4 Exterior plastic composite stair treads. Plastic composite exterior stair treads shall comply with the provisions of this section and Section R507.2.2.

R311.7.6 Landings for stairways. There shall be a floor or landing at the top and bottom of each stairway. The width perpendicular to the direction of travel shall be not less than the width of the flight served. For landings of shapes other than square or rectangular, the depth at the walk line and the total area shall be not less than that of a quarter circle with a radius equal to the required landing width. Where the stairway has a straight run, the depth in the direction of travel shall be not less than 36 inches (914 mm).

Exception: A floor or landing is not required at the top of an interior flight of stairs, including stairs in an enclosed garage, provided that a door does not swing over the stairs.

R311.7.7 Stairway walking surface. The walking surface of treads and landings of stairways shall be sloped not steeper than one unit vertical in 48 inches horizontal (2-percent slope).

R311.7.8 Handrails. Handrails shall be provided on not less than one side of each flight of stairs with four or more risers.

R311.7.8.1 Height. Handrail height, measured vertically from the sloped plane adjoining the tread nosing, or finish surface of ramp slope, shall be not less than 34 inches (864 mm) and not more than 38 inches (965 mm).

Exceptions:

1. The use of a volute, turnout or starting easing shall be allowed over the lowest tread.
2. Where handrail fittings or bendings are used to provide continuous transition between flights, transitions at winder treads, the transition from handrail to *guard*, or used at the start of a flight, the handrail height at the fittings or bendings shall be permitted to exceed 38 inches (956 mm).

R311.7.8.2 Handrail projection. Handrails shall not project more than 4-1/2 inches (114 mm) on either side of the stairway.

Exception: Where nosings of landings, floors or passing flights project into the stairway reducing the clearance at passing handrails, handrails shall project not more than 6-1/2 inches (165 mm) into the stairway, provided that the stair width and handrail clearance are not reduced to less than that required.

R311.7.8.3 Handrail clearance. Handrails adjacent to a wall shall have a space of not less than 1-1/2 inches (38 mm) between the wall and the handrails.

R311.7.8.4 Continuity. Handrails shall be continuous for the full length of the flight, from a point directly above the top riser of the flight to a point directly above the lowest riser of the flight. Handrail ends shall be returned or shall terminate in newel posts or safety terminals.

Exceptions:

1. Handrail continuity shall be permitted to be interrupted by a newel post at a turn in a flight with winders, at a landing, or over the lowest tread.
2. A volute, turnout or starting easing shall be allowed to terminate over the lowest tread.

R311.7.8.5 Grip size. Required handrails shall be of one of the following types or provide equivalent graspability.

1. Type I. Handrails with a circular cross section shall have an outside diameter of not less than 1-1/4 inches (32 mm) and not greater than 2 inches (51 mm). If the handrail is not circular, it shall have a perimeter of not less than 4 inches (102 mm) and not greater than 6-1/4 inches (160 mm) and a cross section of not more than 2-1/4 inches (57 mm). Edges shall have a radius of not less than 0.01 inch (0.25 mm).
2. Type II. Handrails with a perimeter greater than 6-1/4 inches (160 mm) shall have a graspable finger recess area on both sides of the profile. The finger recess shall begin within 3/4 inch (19 mm) measured vertically from the tallest portion of the profile and have a depth of not less than 5/16 inch (8 mm) within 7/8 inch (22 mm) below the widest

portion of the profile. This required depth shall continue for not less than 3/8 inch (10 mm) to a level that is not less than 1-3/4 inches (45 mm) below the tallest portion of the profile. The width of the handrail above the recess shall be not less than 1-1/4 inches (32 mm) and not more than 2-3/4 inches (70 mm). Edges shall have a radius of not less than 0.01 inch (0.25 mm).

R311.7.8.6 Exterior plastic composite handrails. Plastic composite exterior handrails shall comply with the requirements of Section R507.2.2.

R311.7.9 Illumination. Stairways shall be provided with illumination in accordance with Sections R303.7 and R303.8.

R311.7.10 Special stairways. Spiral stairways and bulkhead enclosure stairways shall comply with the requirements of Section R311.7 except as specified in Sections R311.7.10.1 and R311.7.10.2.

R311.7.10.1 Spiral stairways. The clear width at and below the handrails at spiral stairways shall be not less than 26 inches (660 mm) and the walkline radius shall be not greater than 24-1/2 inches (622 mm). Each tread shall have a depth of not less than 6-3/4 inches (171 mm) at the walkline. Treads shall be identical, and the rise shall be not more than 9-1/2 inches (241 mm). Headroom shall be not less than 6 feet 6 inches (1982 mm).

R311.7.10.2 Bulkhead enclosure stairways. Stairways serving bulkhead enclosures, not part of the required building egress, providing access from the outside *grade* level to the *basement* shall be exempt from the requirements of Sections R311.3 and R311.7 where the height from the *basement* finished floor level to *grade* adjacent to the stairway is not more than 8 feet (2438 mm) and the *grade* level opening to the stairway is covered by a bulkhead enclosure with hinged doors or other *approved* means.

R311.7.11 Alternating tread devices. Alternating tread devices shall not be used as an element of a means of egress. Alternating tread devices shall be permitted provided that a required means of egress stairway or ramp serves the same space at each adjoining level or where a means of egress is not required. The clear width at and below the handrails shall be not less than 20 inches (508 mm).

Exception: Alternating tread devices are allowed to be used as an element of a means of egress for lofts, mezzanines and similar areas of 200 gross square feet (18.6 m²) or less where such devices do not provide exclusive access to a kitchen or bathroom.

R311.7.11.1 Treads of alternating tread devices. Alternating tread devices shall have a tread depth of not less than 5 inches (127 mm), a projected tread depth of not less than 8-1/2 inches (216 mm), a tread width of not less than 7 inches (178 mm) and a riser height of not more than 9-1/2 inches (241 mm). The tread depth shall be measured horizontally between the vertical planes of the foremost projections of adjacent treads. The riser height shall be measured vertically between the leading edges of adjacent treads. The riser height and tread depth provided shall result in an angle of ascent from the horizontal of between 50 and 70 degrees (0.87 and 1.22 rad). The initial tread of the device shall begin at the same elevation as the platform, landing or floor surface.

R311.7.11.2 Handrails of alternating tread devices. Handrails shall be provided on both sides of alternating tread devices and shall comply with Sections R311.7.8.2 to R311.7.8.6. Handrail height shall be uniform, not less than 30 inches (762 mm) and not more than 34 inches (864 mm).

R311.7.12 Ship's ladders. Ship's ladders shall not be used as an element of a means of egress. Ship's ladders shall be permitted provided that a required means of egress stairway or ramp serves the same space at each adjoining level or where a means of egress is not required. The clear width at and below the handrails shall be not less than 20 inches.

Exception: Ship's ladders are allowed to be used as an element of a means of egress for lofts, mezzanines and similar areas of 200 gross square feet (18.6 m²) or less that do not provide exclusive access to a kitchen or bathroom.

R311.7.12.1 Treads of ship's ladders. Treads shall have a depth of not less than 5 inches (127 mm). The tread shall be projected such that the total of the tread depth plus the nosing projection is not less than 8-1/2 inches (216 mm). The riser height shall be not more than 9-1/2 inches (241 mm).

R311.7.12.2 Handrails of ship's ladders. Handrails shall be provided on both sides of ship's ladders and shall comply with Sections R311.7.8.2 to R311.7.8.6. Handrail height shall be uniform, not less than 30 inches (762 mm) and not more than 34 inches (864 mm).

R311.8 Ramps.

R311.8.1 Maximum slope. Ramps serving the egress door required by Section R311.2 shall have a slope of not more than 1 unit vertical in 12 units horizontal (8.3-percent slope). Other ramps shall have a maximum slope of 1 unit vertical in 8 units horizontal (12.5 percent).

Exception: Where it is technically infeasible to comply because of site constraints, ramps shall have a slope of not more than 1 unit vertical in 8 units horizontal (12.5 percent).

R311.8.2 Landings required. There shall be a floor or landing at the top and bottom of each ramp, where doors open onto ramps, and where ramps change directions. The width of the landing perpendicular to the ramp slope shall be not less than 36 inches (914 mm).

R311.8.3 Handrails required. Handrails shall be provided on not less than one side of ramps exceeding a slope of one unit vertical in 12 units horizontal (8.33-percent slope).

R311.8.3.1 Height. Handrail height, measured above the finished surface of the ramp slope, shall be not less than 34 inches (864 mm) and not more than 38 inches (965 mm).

R311.8.3.2 Grip size. Handrails on ramps shall comply with Section R311.7.8.5.

R311.8.3.3 Continuity. Handrails where required on ramps shall be continuous for the full length of the ramp. Handrail ends shall be returned or shall terminate in newel posts or safety terminals. Handrails adjacent to a wall shall have a space of not less than 1-1/2 inches (38 mm) between the wall and the handrails.

SECTION R312 GUARDS AND WINDOW FALL PROTECTION

R312.1 Guards. *Guards* shall be provided in accordance with Sections R312.1.1 through R312.1.4.

R312.1.1 Where required. *Guards* shall be provided for those portions of open-sided walking surfaces, including stairs, ramps and landings, that are located more than 30 inches (762 mm) measured vertically to the floor or *grade* below at any point within 36 inches (914 mm) horizontally to the edge of the open side. Insect screening shall not be considered as a *guard*.

R312.1.2 Height. Required *guards* at open-sided walking surfaces, including stairs, porches, balconies or landings, shall be not less than 36 inches (914 mm) in height as measured vertically above the adjacent walking surface or the line connecting the *nosings*.

Exceptions:

1. *Guards* on the open sides of stairs shall have a height of not less than 34 inches (864 mm) measured vertically from a line connecting the *nosings*.
2. Where the top of the *guard* serves as a handrail on the open sides of stairs, the top of the *guard* shall be not less than 34 inches (864 mm) and not more than 38 inches (965 mm) as measured vertically from a line connecting the *nosings*.

R312.1.3 Opening limitations. Required *guards* shall not have openings from the walking surface to the required *guard* height that allow passage of a sphere 4 inches (102 mm) in diameter.

Exceptions:

1. The triangular openings at the open side of stair, formed by the riser, tread and bottom rail of a *guard*, shall not allow passage of a sphere 6 inches (153 mm) in diameter.
2. *Guards* on the open side of stairs shall not have openings that allow passage of a sphere 4-3/8 inches (111 mm) in diameter.

R312.1.4 Exterior plastic composite guards. Plastic composite exterior *guards* shall comply with the requirements of Section R317.4.

R312.2 Window fall protection. Window fall protection shall be provided in accordance with Sections R312.2.1 and R312.2.2.

R312.2.1 Window sills. In dwelling units, where the top of the sill of an operable window opening is located less than 24 inches (610 mm) above the finished floor and greater than 72 inches (1829 mm) above the finished *grade* or other surface below on the exterior of the building, the operable window shall comply with one of the following:

1. Operable window openings will not allow a 4-inch-diameter (102 mm) sphere to pass through where the openings are in their largest opened position.
2. Operable windows are provided with window fall prevention devices that comply with ASTM F2090.
3. Operable windows are provided with window opening control devices that comply with Section R312.2.2.

R312.2.2 Window opening control devices. Window opening control devices shall comply with ASTM F2090. The window opening control device, after operation to release the control device allowing the window to fully open, shall not reduce the net clear opening area of the window unit to less than the area required by Section R310.2.1.

SECTION R313 AUTOMATIC FIRE SPRINKLER SYSTEMS

[W][S] **R313.1 Townhouse automatic fire sprinkler systems.** An automatic residential fire sprinkler system shall be installed in ~~((townhouses))~~ a townhouse unit.

Exception: An automatic residential fire sprinkler system shall not be required where *additions* or *alterations* are made to an existing ~~((townhouses))~~ townhouse unit that does not have an automatic residential fire sprinkler system installed.

[W] **R313.1.1 Design and installation.** Automatic residential fire sprinkler systems for ~~((townhouses))~~ a townhouse unit shall be designed and installed in accordance with Section P2904 or NFPA 13D.

~~[W] ((R313.2 One and two family dwellings automatic fire sprinkler systems. An automatic residential fire sprinkler system shall be installed in one and two family dwellings.~~

~~**Exception:** An automatic residential fire sprinkler system shall not be required for *additions* or *alterations* to existing buildings that are not already provided with an automatic residential sprinkler system.~~

~~**R313.2.1 Design and installation.** Automatic residential fire sprinkler systems shall be designed and installed in accordance with Section P2904 or NFPA 13D.))~~

SECTION R314 SMOKE ALARMS

[W] **R314.1 General.** Smoke alarms, heat detectors, and heat alarms shall comply with NFPA 72 and Section R314.

[W] **R314.1.1 Listings.** Smoke alarms shall be *listed* in accordance with UL 217. Heat detectors and heat alarms shall be listed for the intended application. Combination smoke and carbon monoxide alarms shall be *listed* in accordance with UL 217 and UL 2034.

[W] **R314.2 Where required.** Smoke alarms, heat detectors, and heat alarms shall be provided in accordance with this section.

[W] **R314.2.1 New construction.** Smoke alarms shall be provided in *dwelling units*. A heat detector or heat alarm shall be provided in new attached garages.

[W] **R314.2.2 Alterations, repairs and additions.** Where *alterations*, *repairs* or *additions* requiring a permit occur, where one or more sleeping rooms are added or created in existing dwellings, or where an accessory dwelling unit is created within an existing dwelling unit, ((the individual)) each dwelling unit shall be equipped with smoke alarms ~~((heated))~~ as required for new *dwellings*.

Exceptions:

1. Work involving the exterior surfaces of *dwellings*, such as the replacement of roofing or siding, the *addition* or replacement of windows or doors, or the addition of a porch or deck.
2. Installation, alteration or repairs of plumbing or mechanical systems.

[W] **R314.2.3 New attached garages.** A heat detector or heat alarm rated for the ambient outdoor temperatures and humidity shall be installed in new garages that are attached to or located under new and existing dwellings. Heat detectors and heat alarms shall be installed in a central location and in accordance with the manufacturer's instructions.

EXCEPTION: Heat detectors and heat alarms shall not be required in dwellings without commercial power.

[W] **R314.3 Location.** Smoke alarms shall be installed in the following locations:

1. In each sleeping room or sleeping loft.
2. Outside each separate sleeping area in the immediate vicinity of the bedrooms.
3. On each additional *story* of the *dwelling*, including *basements* and *habitable attics* and not including crawl spaces and uninhabitable *attics*. In *dwellings* or *dwelling units* with split levels and without an intervening door between the adjacent levels, a smoke alarm installed on the upper level shall suffice for the adjacent lower level provided that the lower level is less than one full *story* below the upper level.
4. Smoke alarms shall be installed not less than 3 feet (914 mm) horizontally from the door or opening of a bathroom that contains a bathtub or shower unless this would prevent placement of a smoke alarm required by this section.
5. In napping areas in family home child care.

R314.3.1 Installation near cooking appliances. Smoke alarms shall not be installed in the following locations unless this would prevent placement of a smoke alarm in a location required by Section R314.3.

1. Ionization smoke alarms shall not be installed less than 20 feet (6096 mm) horizontally from a permanently installed cooking *appliance*.

2. Ionization smoke alarms with an alarm-silencing switch shall not be installed less than 10 feet (3048 mm) horizontally from a permanently installed cooking *appliance*.
3. Photoelectric smoke alarms shall not be installed less than 6 feet (1828 mm) horizontally from a permanently installed cooking *appliance*.

[W] R314.4 Interconnection. Where more than one smoke alarm is required to be installed within an individual dwelling unit in accordance with Section ~~((R314.3))~~ R314.2, the alarm devices shall be interconnected in such a manner that the actuation of one alarm will activate all of the alarms in the individual *dwelling unit*. Where an accessory dwelling unit is created within an existing dwelling unit all required smoke alarms, in the accessory dwelling unit and the primary dwelling unit, shall be interconnected in such a manner that the actuation of one alarm will activate all alarms in both the primary dwelling unit and the accessory dwelling unit. Physical interconnection of smoke alarms shall not be required where listed wireless alarms are installed and all alarms sound upon activation of one alarm.

Exception: Smoke alarms and alarms installed to satisfy Section R314.4.1 shall not be required to be interconnected to existing smoke alarms where such existing smoke alarms are not interconnected or where such new smoke alarm or alarm is not capable of being interconnected to the existing smoke alarms.

[W] R314.4.1 Heat detection interconnection. Heat detectors and heat alarms shall be connected to an alarm or a smoke alarm that is installed in the dwelling. Alarms and smoke alarms that are installed for this purpose shall be located in a hallway, room, or other location that will provide occupant notification.

R314.5 Combination alarms. Combination smoke and carbon monoxide alarms shall be permitted to be used in lieu of smoke alarms.

[W] R314.6 Power source. Smoke alarms, heat alarms, and heat detectors shall receive their primary power from the building wiring where such wiring is served from a commercial source and, where primary power is interrupted, shall receive power from a battery. Wiring shall be permanent and without a disconnecting switch other than those required for overcurrent protection.

Exceptions:

1. Smoke alarms shall be permitted to be battery operated where installed in buildings without commercial power.
2. Smoke alarms installed in accordance with Section R314.2.2 shall be permitted to be battery powered.

R314.7 Fire alarm systems. Fire alarm systems shall be permitted to be used in lieu of smoke alarms and shall comply with Sections R314.7.1 through R314.7.4.

R314.7.1 General. Fire alarm systems shall comply with the provisions of this code and the household fire warning *equipment* provisions of NFPA 72. Smoke detectors shall be *listed* in accordance with UL 268.

R314.7.2 Location. Smoke detectors shall be installed in the locations specified in Section R314.3.

R314.7.3 Permanent fixture. Where a household fire alarm system is installed, it shall become a permanent fixture of the occupancy, owned by the homeowner.

R314.7.4 Combination detectors. Combination smoke and carbon monoxide detectors shall be permitted to be installed in fire alarm systems in lieu of smoke detectors, provided that they are *listed* in accordance with UL 268 and UL 2075.

SECTION R315 CARBON MONOXIDE ALARMS

R315.1 General. Carbon monoxide alarms shall comply with Section R315.

R315.1.1 Listings. Carbon monoxide alarms shall be *listed* in accordance with UL 2034. Combination carbon monoxide and smoke alarms shall be *listed* in accordance with UL 2034 and UL 217.

[W] R315.2 Where required. Carbon monoxide alarms shall be provided in accordance with Sections R315.2.1 and R315.2.2.

[W] R315.2.1 New construction. For new construction, an *approved* carbon monoxide alarm((s)) shall be ((provided in dwelling units where either or both of the following conditions exist)) installed outside of each separate sleeping area in the immediate vicinity of the bedrooms in *dwelling units* and on each level of the dwelling in accordance with the manufacturer's recommendation.

~~((1. The *dwelling unit* contains a fuel-fired *appliance*.~~

~~2. The *dwelling unit* has an attached garage with an opening that communicates with the dwelling unit.))~~

[W] R315.2.2 Alterations, repairs and additions. ~~((Where *alterations, repairs* or *additions* requiring a permit occur, the individual *dwelling unit* shall be equipped with carbon monoxide alarms located as required for new *dwelling*s.)) Existing dwellings shall be equipped with carbon monoxide alarms in accordance with Section R315.2.1. An inspection will occur where *alterations, repairs, or additions* requiring a permit occur, or where one or more sleeping rooms are added or created.~~

Exceptions:

1. Work involving the exterior surfaces of *dwelling*s, such as the replacement of roofing or siding, or the addition or replacement of windows or doors, or the addition of a porch or deck, is exempt from the inspection requirements of this section.
2. Installation, alteration or repairs of non-fuel-burning plumbing, electrical or mechanical systems are exempt from the requirements of this section.
3. Owner-occupied single-family residences legally occupied before July 26, 2009. See RCW 19.27.530 (2)(b).

[W] R315.3 Location. Carbon monoxide alarms in *dwelling units* shall be installed outside of each separate sleeping area in the immediate vicinity of the bedrooms and on each level of the dwelling and in accordance with the manufacturer's recommendations. Where a fuel-burning *appliance* is located within a bedroom or its attached bathroom, a carbon monoxide alarm shall be installed within the bedroom.

R315.4 Combination alarms. Combination carbon monoxide and smoke alarms shall be permitted to be used in lieu of carbon monoxide alarms.

R315.5 Interconnectivity. Where more than one carbon monoxide alarm is required to be installed within an individual *dwelling unit* in accordance with Section R315.3, the alarm devices shall be interconnected in such a manner that the actuation of one alarm will activate all of the alarms in the individual *dwelling unit*. Physical interconnection of carbon monoxide alarms shall not be required where *listed* wireless alarms are installed and all alarms sound upon activation of one alarm.

Exception: Interconnection of carbon monoxide alarms in existing areas shall not be required where *alterations* or *repairs* do not result in removal of interior wall or ceiling finishes exposing the structure, unless there is an *attic*, crawl space or basement available that could provide access for interconnection without the removal of interior finishes.

R315.6 Power source. Carbon monoxide alarms shall receive their primary power from the building wiring where such wiring is served from a commercial source and, where primary power is interrupted, shall receive power from a battery. Wiring shall be permanent and without a disconnecting switch other than those required for overcurrent protection.

Exceptions:

1. Carbon monoxide alarms shall be permitted to be battery operated where installed in buildings without commercial power.
2. Carbon monoxide alarms installed in accordance with Section R315.2.2 shall be permitted to be battery powered.

R315.7 Carbon monoxide detection systems. Carbon monoxide detection systems shall be permitted to be used in lieu of carbon monoxide alarms and shall comply with Sections R315.7.1 through R315.7.4.

R315.7.1 General. Household carbon monoxide detection systems shall comply with NFPA 720. Carbon monoxide detectors shall be *listed* in accordance with UL 2075.

R315.7.2 Location. Carbon monoxide detectors shall be installed in the locations specified in Section R315.3. These locations supersede the locations specified in NFPA 720.

R315.7.3 Permanent fixture. Where a household carbon monoxide detection system is installed, it shall become a permanent fixture of the occupancy and owned by the homeowner.

R315.7.4 Combination detectors. Combination carbon monoxide and smoke detectors installed in carbon monoxide detection systems in lieu of carbon monoxide detectors shall be *listed* in accordance with UL 2075 and UL 268.

SECTION R316 FOAM PLASTIC

R316.1 General. The provisions of this section shall govern the materials, design, application, construction and installation of foam plastic materials.

R316.2 Labeling and identification. Packages and containers of foam plastic insulation and foam plastic insulation components delivered to the job site shall bear the *label* of an *approved agency* showing the manufacturer's name, the product listing, product identification and information sufficient to determine that the end use will comply with the requirements.

R316.3 Surface burning characteristics. Unless otherwise allowed in Section R316.5, foam plastic, or foam plastic cores used as a component in manufactured assemblies, used in building construction shall have a flame spread index of not more than 75 and shall have a smoke-developed index of not more than 450 when tested in the maximum thickness and density intended for use in accordance with ASTM E84 or UL 723. Loose-fill-type foam plastic insulation shall be tested as board stock for the flame spread index and smoke-developed index.

Exception: Foam plastic insulation more than 4 inches (102 mm) thick shall have a flame spread index of not more than 75 and a smoke-developed index of not more than 450 where tested at a thickness of not more than 4 inches (102 mm), provided that the end use is *approved* in accordance with Section R316.6 using the thickness and density intended for use.

R316.4 Thermal barrier. Unless otherwise allowed in Section R316.5, foam plastic shall be separated from the interior of a building by an *approved* thermal barrier of not less than 1/2-inch (12.7 mm) gypsum wallboard, 23/32-inch (18.2 mm) wood structural panel or a material that is tested in accordance with and meets the acceptance criteria of both the Temperature Transmission Fire Test and the Integrity Fire Test of NFPA 275.

R316.5 Specific requirements. The following requirements shall apply to these uses of foam plastic unless specifically *approved* in accordance with Section R316.6 or by other sections of the code or the requirements of Sections R316.2 through R316.4 have been met.

R316.5.1 Masonry or concrete construction. The thermal barrier specified in Section R316.4 is not required in a masonry or concrete wall, floor or roof where the foam plastic insulation is separated from the interior of the building by not less than a 1-inch (25 mm) thickness of masonry or concrete.

R316.5.2 Roofing. The thermal barrier specified in Section R316.4 is not required where the foam plastic in a roof assembly or under a roof covering is installed in accordance with the code and the manufacturer's instructions and is separated from the interior of the building by tongue-and-groove wood planks or wood structural panel sheathing, in accordance with Section R803, that is not less than 15/32 inch (11.9 mm) thick bonded with exterior glue, identified as Exposure 1 and with edges supported by blocking or tongue-and-groove joints or an equivalent material. The smoke-developed index for roof applications shall not be limited.

R316.5.3 Attics. The thermal barrier specified in Section R316.4 is not required where all of the following apply:

1. Attic access is required by Section R807.1.
2. The space is entered only for purposes of repairs or maintenance.
3. The foam plastic insulation has been tested in accordance with Section R316.6 or the foam plastic insulation is protected against ignition using one of the following ignition barrier materials:
 - 3.1. 1-1/2-inch-thick (38 mm) mineral fiber insulation.
 - 3.2. 1/4-inch-thick (6.4 mm) wood structural panels.
 - 3.3. 3/8-inch (9.5 mm) particleboard.
 - 3.4. 1/4-inch (6.4 mm) hardboard.
 - 3.5. 3/8-inch (9.5 mm) gypsum board.
 - 3.6. Corrosion-resistant steel having a base metal thickness of 0.016 inch (0.406 mm).
 - 3.7. 1-1/2-inch-thick (38 mm) cellulose insulation.
 - 3.8. 1/4-inch (6.4 mm) fiber-cement panel, soffit or backer board.

The ignition barrier is not required where the foam plastic insulation has been tested in accordance with Section R316.6.

R316.5.4 Crawl spaces. The thermal barrier specified in Section R316.4 is not required where all of the following apply:

1. Crawl space access is required by Section R408.4.
2. Entry is made only for purposes of repairs or maintenance.
3. The foam plastic insulation has been tested in accordance with Section R316.6 or the foam plastic insulation is protected against ignition using one of the following ignition barrier materials:
 - 3.1. 1-1/2-inch-thick (38 mm) mineral fiber insulation.
 - 3.2. 1/4-inch-thick (6.4 mm) wood structural panels.
 - 3.3. 3/8-inch (9.5 mm) particleboard.
 - 3.4. 1/4-inch (6.4 mm) hardboard.
 - 3.5. 3/8-inch (9.5 mm) gypsum board.
 - 3.6. Corrosion-resistant steel having a base metal thickness of 0.016 inch (0.406 mm).
 - 3.7. 1/4-inch (6.4 mm) fiber-cement panel, soffit or backer board.

R316.5.5 Foam-filled exterior doors. Foam-filled exterior doors are exempt from the requirements of Sections R316.3 and R316.4.

R316.5.6 Foam-filled garage doors. Foam-filled garage doors in attached or detached garages are exempt from the requirements of Sections R316.3 and R316.4.

R316.5.7 Foam backer board. The thermal barrier specified in Section R316.4 is not required where siding backer board foam plastic insulation has a thickness of not more than 0.5 inch (12.7 mm) and a potential heat of not more than 2000 Btu per square foot (22 720 kJ/m²) when tested in accordance with NFPA 259 and it complies with one or more of the following:

1. The foam plastic insulation is separated from the interior of the building by not less than 2 inches (51 mm) of mineral fiber insulation.
2. The foam plastic insulation is installed over existing *exterior wall* finish in conjunction with re-siding.
3. The foam plastic insulation has been tested in accordance with Section R316.6.

R316.5.8 Re-siding. The thermal barrier specified in Section R316.4 is not required where the foam plastic insulation is installed over existing *exterior wall* finish in conjunction with re-siding provided that the foam plastic has a thickness of not more than 0.5 inch (12.7 mm) and a potential heat of not more than 2000 Btu per square foot (22 720 kJ/m²) when tested in accordance with NFPA 259.

R316.5.9 Interior trim. The thermal barrier specified in Section R316.4 is not required for exposed foam plastic interior trim, provided that all of the following are met:

1. The density is not less than 20 pounds per cubic foot (320 kg/m³).
2. The thickness of the trim is not more than 0.5 inch (12.7 mm) and the width is not more than 8 inches (204 mm).
3. The interior trim shall not constitute more than 10 percent of the aggregate wall and ceiling area of any room or space.
4. The flame spread index does not exceed 75 when tested in accordance with ASTM E84 or UL 723. The smoke-developed index is not limited.

R316.5.10 Interior finish. Foam plastics used as interior finishes shall comply with Section R316.6 and shall meet the flame spread index and smoke-developed index requirements of Sections R302.9.1 and R302.9.2.

R316.5.11 Sill plates and headers. Foam plastic be spray applied to sill plates and headers or installed in the perimeter joist space without the thermal barrier specified in Section R316.4 shall comply with all of the following:

1. The thickness of the foam plastic shall be not more than 3-1/4 inches (83 mm).
2. The density of the foam plastic shall be in the range of 0.5 to 2.0 pounds per cubic foot (8 to 32 kg/m³).
3. The foam plastic shall have a flame spread index of 25 or less and an accompanying smoke-developed index of 450 or less when tested in accordance with ASTM E84 or UL 723.

R316.5.12 Sheathing. Foam plastic insulation used as sheathing shall comply with Section R316.3 and Section R316.4. Where the foam plastic sheathing is exposed to the *attic* space at a gable or kneewall, the provisions of Section R316.5.3 shall apply. Where foam plastic insulation is used as *exterior wall* sheathing on framed wall assemblies, it shall comply with Section R316.8.

R316.5.13 Floors. The thermal barrier specified in Section R316.4 is not required to be installed on the walking surface of a structural floor system that contains foam plastic insulation where the foam plastic is covered by not more than a nominal 1/2-inch-thick (12.7 mm) wood structural panel or equivalent. The thermal barrier specified in Section R316.4 is required on the underside of the structural floor system that contains foam plastic insulation where the underside of the structural floor system is exposed to the interior of the building.

R316.6 Specific approval. Foam plastic not meeting the requirements of Sections R316.3 through R316.5 shall be specifically *approved* on the basis of one of the following *approved* tests: NFPA 286 with the acceptance criteria of Section R302.9.4, FM 4880, UL 1040 or UL 1715, or fire tests related to actual end-use configurations. Approval shall be based on the actual end-use configuration and shall be performed on the finished foam plastic assembly in the maximum thickness intended for use. Assemblies tested shall include seams, joints and other typical details used in the installation of the assembly and shall be tested in the manner intended for use.

R316.7 Termite damage. The use of foam plastics in areas of “very heavy” termite infestation probability shall be in accordance with Section R318.4.

R316.8 Wind resistance. Foam plastic insulation complying with ASTM C578 and ASTM C1289 and used as *exterior wall* sheathing on framed wall assemblies shall comply with SBCA FS 100 for wind pressure resistance unless installed directly over a sheathing material that is separately capable of resisting the wind load or otherwise exempted from the scope of SBCA FS 100.

SECTION R317 PROTECTION OF WOOD AND WOOD-BASED PRODUCTS AGAINST DECAY

R317.1 Location required. Protection of wood and wood-based products from decay shall be provided in the following locations by the use of naturally durable wood or wood that is preservative-treated in accordance with AWPA U1.

1. Wood joists or the bottom of a wood structural floor where closer than 18 inches (457 mm) or wood girders where closer than 12 inches (305 mm) to the exposed ground in crawl spaces or unexcavated area located within the periphery of the building foundation.
2. Wood framing members that rest on concrete or masonry exterior foundation walls and are less than 8 inches (203 mm) from the exposed ground.
3. Sills and sleepers on a concrete or masonry slab that is in direct contact with the ground unless separated from such slab by an impervious moisture barrier.
4. The ends of wood girders entering exterior masonry or concrete walls having clearances of less than 1/2 inch (12.7 mm) on tops, sides and ends.
5. Wood siding, sheathing and wall framing on the exterior of a building having a clearance of less than 6 inches (152 mm) from the ground or less than 2 inches (51 mm) measured vertically from concrete steps, porch slabs, patio slabs and similar horizontal surfaces exposed to the weather.
6. Wood structural members supporting moisture-permeable floors or roofs that are exposed to the weather, such as concrete or masonry slabs, unless separated from such floors or roofs by an impervious moisture barrier.
7. Wood furring strips or other wood framing members attached directly to the interior of exterior masonry walls or concrete walls below *grade* except where an *approved* vapor retarder is applied between the wall and the furring strips or framing members.

R317.1.1 Field treatment. Field-cut ends, notches and drilled holes of preservative-treated wood shall be treated in the field in accordance with AWPA M4.

R317.1.2 Ground contact. All wood in contact with the ground, embedded in concrete in direct contact with the ground or embedded in concrete exposed to the weather that supports permanent structures intended for human occupancy shall be *approved* pressure-preservative-treated wood suitable for ground contact use, except that untreated wood used entirely below groundwater level or continuously submerged in fresh water shall not be required to be pressure-preservative treated.

R317.1.3 Geographical areas. In geographical areas where experience has demonstrated a specific need, *approved* naturally durable or pressure-preservative-treated wood shall be used for those portions of wood members that form the structural supports of buildings, balconies, porches or similar permanent building appurtenances where those members are exposed to the weather without adequate protection from a roof, eave, overhang or other covering that would prevent moisture or water accumulation on the surface or at joints between members. Depending on local experience, such members typically include:

1. Horizontal members such as girders, joists and decking.
2. Vertical members such as posts, poles and columns.
3. Both horizontal and vertical members.

R317.1.4 Wood columns. Wood columns shall be *approved* wood of natural decay resistance or *approved* pressure-preservative-treated wood.

Exceptions:

1. Columns exposed to the weather or in *basements* where supported by concrete piers or metal pedestals projecting 1 inch (25 mm) above a concrete floor or 6 inches (152 mm) above exposed earth and the earth is covered by an *approved* impervious moisture barrier.
2. Columns in enclosed crawl spaces or unexcavated areas located within the periphery of the building where supported by a concrete pier or metal pedestal at a height more than 8 inches (203 mm) from exposed earth and the earth is covered by an impervious moisture barrier.
3. Deck posts supported by concrete piers or metal pedestals projecting not less than 1 inch (25 mm) above a concrete floor or 6 inches (152 mm) above exposed earth.

R317.1.5 Exposed glued-laminated timbers. The portions of glued-laminated timbers that form the structural supports of a building or other structure and are exposed to weather and not properly protected by a roof, eave or similar covering shall be pressure treated with preservative, or be manufactured from naturally durable or preservative-treated wood.

R317.2 Quality mark. Lumber and plywood required to be pressure-preservative treated in accordance with Section R318.1 shall bear the quality *mark* of an *approved* inspection agency that maintains continuing supervision, testing and inspection over the quality of the product and that has been *approved* by an accreditation body that complies with the requirements of the American Lumber Standard Committee treated wood program.

R317.2.1 Required information. The required quality *mark* on each piece of pressure-preservative-treated lumber or plywood shall contain the following information:

1. Identification of the treating plant.

2. Type of preservative.
3. The minimum preservative retention.
4. End use for which the product was treated.
5. Standard to which the product was treated.
6. Identity of the *approved* inspection agency.
7. The designation “Dry,” if applicable.

Exception: Quality *marks* on lumber less than 1 inch (25 mm) nominal thickness, or lumber less than nominal 1 inch by 5 inches (25 mm by 127 mm) or 2 inches by 4 inches (51 mm by 102 mm) or lumber 36 inches (914 mm) or less in length shall be applied by stamping the faces of exterior pieces or by end labeling not less than 25 percent of the pieces of a bundled unit.

R317.3 Fasteners and connectors in contact with preservative-treated and fire-retardant-treated wood. Fasteners, including nuts and washers, and connectors in contact with preservative-treated wood and fire-retardant-treated wood shall be in accordance with this section. The coating weights for zinc-coated fasteners shall be in accordance with ASTM A153. Stainless steel driven fasteners shall be in accordance with the material requirements of ASTM F1667.

R317.3.1 Fasteners for preservative-treated wood. Fasteners, including nuts and washers, for preservative-treated wood shall be of hot-dipped, zinc-coated galvanized steel, stainless steel, silicon bronze or copper. Staples shall be of stainless steel. Coating types and weights for connectors in contact with preservative-treated wood shall be in accordance with the connector manufacturer’s recommendations. In the absence of manufacturer’s recommendations, not less than ASTM A653 type G185 zinc-coated galvanized steel, or equivalent, shall be used.

Exceptions:

1. 1/2-inch-diameter (12.7 mm) or greater steel bolts.
2. Fasteners other than nails, staples and timber rivets shall be permitted to be of mechanically deposited zinc-coated steel with coating weights in accordance with ASTM B695, Class 55 minimum.
3. Plain carbon steel fasteners in SBX/DOT and zinc borate preservative-treated wood in an interior, dry environment shall be permitted.

R317.3.2 Fastenings for wood foundations. Fastenings, including nuts and washers, for wood foundations shall be as required in AWC PWF.

R317.3.3 Fasteners for fire-retardant-treated wood used in exterior applications or wet or damp locations. Fasteners, including nuts and washers, for fire-retardant-treated wood used in exterior applications or wet or damp locations shall be of hot-dipped, zinc-coated galvanized steel, stainless steel, silicon bronze or copper. Fasteners other than nails, staples and timber rivets shall be permitted to be of mechanically deposited zinc-coated steel with coating weights in accordance with ASTM B695, Class 55 minimum.

R317.3.4 Fasteners for fire-retardant-treated wood used in interior applications. Fasteners, including nuts and washers, for fire-retardant-treated wood used in interior locations shall be in accordance with the manufacturer’s recommendations. In the absence of the manufacturer’s recommendations, Section R317.3.3 shall apply.

R317.4 Plastic composites. Plastic composite exterior deck boards, stair treads, guards and handrails containing wood, cellulose or other biodegradable materials shall comply with the requirements of Section R507.2.2.

SECTION R318 PROTECTION AGAINST SUBTERRANEAN TERMITES

R318.1 Subterranean termite control methods. In areas subject to damage from termites as indicated by Table R301.2(1), protection shall be by one, or a combination, of the following methods:

1. Chemical termiticide treatment in accordance with Section R318.2.
2. Termite-baiting system installed and maintained in accordance with the *label*.
3. Pressure-preservative-treated wood in accordance with the provisions of Section R317.1.
4. Naturally durable termite-resistant wood.
5. Physical barriers in accordance with Section R318.3 and used in locations as specified in Section R317.1.
6. Cold-formed steel framing in accordance with Sections R505.2.1 and R603.2.1.

R318.1.1 Quality mark. Lumber and plywood required to be pressure-preservative treated in accordance with Section R318.1 shall bear the quality *mark* of an *approved* inspection agency that maintains continuing supervision, testing and

inspection over the quality of the product and that has been *approved* by an accreditation body that complies with the requirements of the American Lumber Standard Committee treated wood program.

R318.1.2 Field treatment. Field-cut ends, notches and drilled holes of pressure-preservative-treated wood shall be retreated in the field in accordance with AWPA M4.

R318.2 Chemical termiticide treatment. Chemical termiticide treatment shall include soil treatment or field-applied wood treatment. The concentration, rate of application and method of treatment of the chemical termiticide shall be in strict accordance with the termiticide *label*.

R318.3 Barriers. *Approved* physical barriers, such as metal or plastic sheeting or collars specifically designed for termite prevention, shall be installed in a manner to prevent termites from entering the structure. Shields placed on top of an exterior foundation wall shall be used only if in combination with another method of protection.

R318.4 Foam plastic protection. In areas where the probability of termite infestation is “very heavy” as indicated in Figure R301.2(7), extruded and expanded polystyrene, polyisocyanurate and other foam plastics shall not be installed on the exterior face or under interior or exterior foundation walls or slab foundations located below *grade*. The clearance between foam plastics installed above *grade* and exposed earth shall be not less than 6 inches (152 mm).

Exceptions:

1. Buildings where the structural members of walls, floors, ceilings and roofs are entirely of noncombustible materials or pressure-preservative-treated wood.
2. Where in *addition* to the requirements of Section R318.1, an *approved* method of protecting the foam plastic and structure from subterranean termite damage is used.
3. On the interior side of *basement walls*.

SECTION R319 SITE ADDRESS

[S] R319.1 Address identification. Buildings shall be provided with *approved* address identification. The address identification shall be legible and placed in a position that is visible from the street or road fronting the property. Address identification characters shall contrast with their background. Address numbers shall be Arabic numbers or alphabetical letters. Numbers shall not be spelled out. Each character shall be not less than 4 inches (102 mm) in height with a stroke width of not less than 0.5 inch (12.7 mm). Where required by the fire code official, address identification shall be provided in additional *approved* locations to facilitate emergency response. Where access is by means of a private road and the building address cannot be viewed from the public way, a monument, pole or other sign or means shall be used to identify the structure. Address identification shall be maintained.

Premises shall be identified in accordance with *International Building Code* Section 501.2.

SECTION R320 ACCESSIBILITY

R320.1 Scope. Where there are four or more *dwelling units* or sleeping units in a single structure, the provisions of Chapter 11 of the *International Building Code* for Group R-3 shall apply.

R320.1.1 Guestrooms. A *dwelling* with guestrooms shall comply with the provisions of Chapter 11 of the *International Building Code* for Group R-3. For the purpose of applying the requirements of Chapter 11 of the *International Building Code*, guestrooms shall be considered to be sleeping units.

Exception: Owner-occupied lodging houses with five or fewer guestrooms constructed in accordance with the *International Residential Code* are not required to be accessible.

SECTION R321 ELEVATORS AND PLATFORM LIFTS

R321.1 Elevators. Where provided, passenger elevators, limited-use and limited-application elevators or private residence elevators shall comply with ASME A17.1/CSA B44.

R321.2 Platform lifts. Where provided, platform lifts shall comply with ASME A18.1.

R321.3 Accessibility. Elevators or platform lifts that are part of an accessible route required by Chapter 11 of the *International Building Code*, shall comply with ICC A117.1.

SECTION R322 FLOOD-RESISTANT CONSTRUCTION

[S] **R322.1 General.** Buildings and structures constructed in whole or in part in flood hazard areas, including A or V Zones and Coastal A Zones, as established in Table R301.2(1) and areas of special flood hazard as defined in *Seattle Municipal Code Section 25.06.030*, and substantial improvement and repair of substantial damage of buildings and structures in flood hazard areas, shall be designed and constructed in accordance with the provisions contained in this section and *Seattle Municipal Code Chapter 25.06, the Seattle Floodplain Development Ordinance*. Buildings and structures that are located in more than one flood hazard area shall comply with the provisions associated with the most restrictive flood hazard area. Buildings and structures located in whole or in part in identified floodways shall be designed and constructed in accordance with ASCE 24.

R322.1.1 Alternative provisions. As an alternative to the requirements in Section R322, ASCE 24 is permitted subject to the limitations of this code and the limitations therein.

R322.1.2 Structural systems. Structural systems of buildings and structures shall be designed, connected and anchored to resist flotation, collapse or permanent lateral movement due to structural loads and stresses from flooding equal to the design flood elevation.

R322.1.3 Flood-resistant construction. Buildings and structures erected in areas prone to flooding shall be constructed by methods and practices that minimize flood damage.

R322.1.4 Establishing the design flood elevation. The design flood elevation shall be used to define flood hazard areas. At a minimum, the design flood elevation shall be the higher of the following:

1. The base flood elevation at the depth of peak elevation of flooding, including wave height, that has a 1-percent (100-year flood) or greater chance of being equaled or exceeded in any given year.
2. The elevation of the design flood associated with the area designated on a flood hazard map adopted by the community, or otherwise legally designated.

R322.1.4.1 Determination of design flood elevations. If design flood elevations are not specified, the *building official* is authorized to require the applicant to comply with either of the following:

1. Obtain and reasonably use data available from a federal, state or other source.
2. Determine the design flood elevation in accordance with accepted hydrologic and hydraulic engineering practices used to define special flood hazard areas. Determinations shall be undertaken by a registered *design professional* who shall document that the technical methods used reflect currently accepted engineering practice. Studies, analyses and computations shall be submitted in sufficient detail to allow thorough review and *approval*.

R322.1.4.2 Determination of impacts. In riverine flood hazard areas where design flood elevations are specified but floodways have not been designated, the applicant shall demonstrate that the effect of the proposed buildings and structures on design flood elevations, including fill, when combined with other existing and anticipated flood hazard area encroachments, will not increase the design flood elevation more than 1 foot (305 mm) at any point within the *jurisdiction*.

R322.1.5 Lowest floor. The lowest floor shall be the lowest floor of the lowest enclosed area, including *basement*, and excluding any unfinished flood-resistant enclosure that is useable solely for vehicle parking, building access or limited storage provided that such enclosure is not built so as to render the building or structure in violation of this section.

R322.1.6 Protection of mechanical, plumbing and electrical systems. Electrical systems, *equipment* and components; heating, ventilating, air-conditioning; plumbing *appliances* and plumbing fixtures; *duct systems*; and other service *equipment* shall be located at or above the elevation required in Section R322.2 or R322.3. If replaced as part of a substantial improvement, electrical systems, *equipment* and components; heating, ventilating, air-conditioning and plumbing *appliances* and plumbing fixtures; *duct systems*; and other service *equipment* shall meet the requirements of this section. Systems, fixtures, and *equipment* and components shall not be mounted on or penetrate through walls intended to break away under flood loads.

Exception: Locating electrical systems, *equipment* and components; heating, ventilating, air-conditioning; plumbing *appliances* and plumbing fixtures; *duct systems*; and other service *equipment* is permitted below the elevation required in Section R322.2 or R322.3 provided that they are designed and installed to prevent water from entering or accumulating within the components and to resist hydrostatic and hydrodynamic loads and stresses, including the effects of buoyancy, during the occurrence of flooding to the design flood elevation in accordance with ASCE 24. Electrical wiring systems are permitted to be located below the required elevation provided that they conform to the provisions of the electrical part of this code for wet locations.

[S] **R322.1.7 Protection of water supply and sanitary sewage systems.** New and replacement water supply systems shall be designed to minimize or eliminate infiltration of flood waters into the systems in accordance with the plumbing provisions of this code. New and replacement sanitary sewage systems shall be designed to minimize or eliminate infiltration of floodwaters into systems and discharges from systems into floodwaters in accordance with the ((plumbing provisions of this code and Chapter 3 of the *International Private Sewage Disposal Code*)) *Uniform Plumbing Code*.

R322.1.8 Flood-resistant materials. Building materials and installation methods used for flooring and interior and exterior walls and wall coverings below the elevation required in Section R322.2 or R322.3 shall be flood damage-resistant materials that conform to the provisions of FEMA TB-2.

R322.1.9 Manufactured homes. The bottom of the frame of new and replacement *manufactured homes* on foundations that conform to the requirements of Section R322.2 or R322.3, as applicable, shall be elevated to or above the elevations specified in Section R322.2 (flood hazard areas including A Zones) or R322.3 in coastal high-hazard areas (V Zones and Coastal A Zones). The anchor and tie-down requirements of the applicable state or federal requirements shall apply. The foundation and anchorage of *manufactured homes* to be located in identified floodways shall be designed and constructed in accordance with ASCE 24.

R322.1.10 As-built elevation documentation. A registered *design professional* shall prepare and seal documentation of the elevations specified in Section R322.2 or R322.3.

R322.2 Flood hazard areas (including A Zones). Areas that have been determined to be prone to flooding and that are not subject to high-velocity wave action shall be designated as flood hazard areas. Flood hazard areas that have been delineated as subject to wave heights between 1-1/2 feet (457 mm) and 3 feet (914 mm) or otherwise designated by the jurisdiction shall be designated as Coastal A Zones and are subject to the requirements of Section R322.3. Buildings and structures constructed in whole or in part in flood hazard areas shall be designed and constructed in accordance with Sections R322.2.1 through R322.2.3.

[S] R322.2.1 Elevation requirements.

1. Buildings and structures in flood hazard areas, including flood hazard areas designated as Coastal A Zones, shall have the lowest floors elevated to or above the base flood elevation plus 1 foot (305 mm), or the design flood elevation, whichever is higher, or a greater elevation as designated by the *Seattle Municipal Code*.
2. In areas of shallow flooding (AO Zones), buildings and structures shall have the lowest floor (including *basement*) elevated to a height above the highest adjacent *grade* of not less than the depth number specified in feet (mm) on the FIRM plus 1 foot (305 mm), or not less than 3 feet (915 mm) if a depth number is not specified.
3. Basement floors that are below *grade* on all sides shall be elevated to or above base flood elevation plus 1 foot (305 mm), or the design flood elevation, whichever is higher.

Exception: Enclosed areas below the design flood elevation, including *basements* with floors that are not below *grade* on all sides, shall meet the requirements of Section R322.2.2.

R322.2.2 Enclosed area below design flood elevation. Enclosed areas, including crawl spaces, that are below the design flood elevation shall:

1. Be used solely for parking of vehicles, building access or storage.
2. Be provided with flood openings that meet the following criteria and are installed in accordance with Section R322.2.2.1:
 - 2.1. The total net area of nonengineered openings shall be not less than 1 square inch (645 mm²) for each square foot (0.093 m²) of enclosed area where the enclosed area is measured on the exterior of the enclosure walls, or the openings shall be designed as engineered openings and the *construction documents* shall include a statement by a registered *design professional* that the design of the openings will provide for equalization of hydrostatic flood forces on *exterior walls* by allowing for the automatic entry and exit of floodwaters as specified in Section 2.7.2.2 of ASCE 24.
 - 2.2. Openings shall be not less than 3 inches (76 mm) in any direction in the plane of the wall.
 - 2.3. The presence of louvers, blades, screens and faceplates or other covers and devices shall allow the automatic flow of floodwater into and out of the enclosed areas and shall be accounted for in the determination of the net open area.

R322.2.2.1 Installation of openings. The walls of enclosed areas shall have openings installed such that:

1. There shall be not less than two openings on different sides of each enclosed area; if a building has more than one enclosed area below the design flood elevation, each area shall have openings.
2. The bottom of each opening shall be not more than 1 foot (305 mm) above the higher of the final interior grade or floor and the finished exterior grade immediately under each opening.
3. Openings shall be permitted to be installed in doors and windows; doors and windows without installed openings do not meet the requirements of this section.

R322.2.3 Foundation design and construction. Foundation walls for buildings and structures erected in flood hazard areas shall meet the requirements of Chapter 4.

Exception: Unless designed in accordance with Section R404:

1. The unsupported height of 6-inch (152 mm) plain masonry walls shall be not more than 3 feet (914 mm).

2. The unsupported height of 8-inch (203 mm) plain masonry walls shall be not more than 4 feet (1219 mm).
3. The unsupported height of 8-inch (203 mm) reinforced masonry walls shall be not more than 8 feet (2438 mm).

For the purpose of this exception, unsupported height is the distance from the finished *grade* of the under-floor space to the top of the wall.

R322.2.4 Tanks. Underground tanks shall be anchored to prevent flotation, collapse and lateral movement under conditions of the base flood. Above-ground tanks shall be installed at or above the elevation required in Section R322.2.1 or shall be anchored to prevent flotation, collapse and lateral movement under conditions of the base flood.

R322.3 Coastal high-hazard areas (including V Zones and Coastal A Zones, where designated). Areas that have been determined to be subject to wave heights in excess of 3 feet (914 mm) or subject to high-velocity wave action or wave-induced erosion shall be designated as coastal high-hazard areas. Flood hazard areas that have been designated as subject to wave heights between 1-1/2 feet (457 mm) and 3 feet (914 mm) or otherwise designated by the jurisdiction shall be designated as Coastal A Zones. Buildings and structures constructed in whole or in part in coastal high-hazard areas and Coastal A Zones, where designated, shall be designed and constructed in accordance with Sections R322.3.1 through R322.3.10.

[S] R322.3.1 Location and site preparation.

1. New buildings and buildings that are determined to be substantially improved pursuant to Section ((~~R105.3.1.1~~) R105.7.3) shall be located landward of the reach of mean high tide.
2. For any alteration of sand dunes and mangrove stands, the *building official* shall require submission of an engineering analysis that demonstrates that the proposed *alteration* will not increase the potential for flood damage.

R322.3.2 Elevation requirements.

1. Buildings and structures erected within coastal high-hazard areas and Coastal A Zones, shall be elevated so that the bottom of the lowest horizontal structural members supporting the lowest floor, with the exception of piling, pile caps, columns, grade beams and bracing, is elevated to or above the base flood elevation plus 1 foot (305 mm) or the design flood elevation, whichever is higher.
2. Basement floors that are below *grade* on all sides are prohibited.
3. The use of fill for structural support is prohibited.
4. Minor grading, and the placement of minor quantities of fill, shall be permitted for landscaping and for drainage purposes under and around buildings and for support of parking slabs, pool decks, patios and walkways.
5. Walls and partitions enclosing areas below the design flood elevation shall meet the requirements of Sections R322.3.5 and R322.3.6.

R322.3.3 Foundations. Buildings and structures erected in coastal high-hazard areas and Coastal A Zones shall be supported on pilings or columns and shall be adequately anchored to such pilings or columns. The space below the elevated building shall be either free of obstruction or, if enclosed with walls, the walls shall meet the requirements of Section R322.3.5. Pilings shall have adequate soil penetrations to resist the combined wave and wind loads (lateral and uplift). Water-loading values used shall be those associated with the design flood. Wind-loading values shall be those required by this code. Pile embedment shall include consideration of decreased resistance capacity caused by scour of soil strata surrounding the piling. Pile systems design and installation shall be certified in accordance with Section R322.3.9. Spread footing, mat, raft or other foundations that support columns shall not be permitted where soil investigations that are required in accordance with Section R401.4 indicate that soil material under the spread footing, mat, raft or other foundation is subject to scour or erosion from wave-velocity flow conditions. If permitted, spread footing, mat, raft or other foundations that support columns shall be designed in accordance with ASCE 24.

Exception: In Coastal A Zones, stem wall foundations supporting a floor system above and backfilled with soil or gravel to the underside of the floor system shall be permitted provided that the foundations are designed to account for wave action, debris impact, erosion and local scour. Where soils are susceptible to erosion and local scour, stem wall foundations shall have deep footings to account for the loss of soil.

R322.3.4 Concrete slabs. Concrete slabs used for parking, floors of enclosures, landings, decks, walkways, patios and similar uses that are located beneath structures, or slabs that are located such that if undermined or displaced during base flood conditions could cause structural damage to the building foundation, shall be designed and constructed in accordance with one of the following:

1. To be structurally independent of the foundation system of the structure, to not transfer flood loads to the main structure, and to be frangible and break away under flood conditions prior to base flood conditions. Slabs shall be a maximum of 4 inches (102 mm) thick, shall not have turned-down edges, shall not contain reinforcing, shall have isolation joints at pilings and columns, and shall have control or construction joints in both directions spaced not more than 4 feet (1219 mm) apart.

2. To be self-supporting, structural slabs capable of remaining intact and functional under base flood conditions, including erosion and local scour, and the main structure shall be capable of resisting any added flood loads and effects of local scour caused by the presence of the slabs.

R322.3.5 Walls below design flood elevation. Walls and partitions are permitted below the elevated floor, provided that such walls and partitions are not part of the structural support of the building or structure and:

1. Electrical, mechanical and plumbing system components are not to be mounted on or penetrate through walls that are designed to break away under flood loads; and
2. Are constructed with insect screening or open lattice; or
3. Are designed to break away or collapse without causing collapse, displacement or other structural damage to the elevated portion of the building or supporting foundation system. Such walls, framing and connections shall have a resistance of not less than 10 (479 Pa) and not more than 20 pounds per square foot (958 Pa) as determined using allowable stress design; or
4. Where wind loading values of this code exceed 20 pounds per square foot (958 Pa), as determined using allowable stress design, the *construction documents* shall include documentation prepared and sealed by a registered *design professional* that:
 - 4.1. The walls and partitions below the design flood elevation have been designed to collapse from a water load less than that which would occur during the base flood.
 - 4.2. The elevated portion of the building and supporting foundation system have been designed to withstand the effects of wind and flood loads acting simultaneously on structural and nonstructural building components. Water-loading values used shall be those associated with the design flood. Wind-loading values shall be those required by this code.
5. Walls intended to break away under flood loads as specified in Item 3 or 4 have flood openings that meet the criteria in Section R322.2.2, Item 2.

R322.3.6 Enclosed areas below design flood elevation. Enclosed areas below the design flood elevation shall be used solely for parking of vehicles, building access or storage.

R322.3.6.1 Protection of building envelope. An exterior door that meets the requirements of Section R609 shall be installed at the top of stairs that provide access to the building and that are enclosed with walls designed to break away in accordance with Section R322.3.5.

R322.3.7 Stairways and ramps. Stairways and ramps that are located below the lowest floor elevations specified in Section R322.3.2 shall comply with one or more of the following:

1. Be designed and constructed with open or partially open risers and guards.
2. Stairways and ramps not part of the required means of egress shall be designed and constructed to break away during design flood conditions without causing damage to the building or structure, including foundation.
3. Be retractable, or able to be raised to or above the lowest floor elevation, provided that the ability to be retracted or raised prior to the onset of flooding is not contrary to the means of egress requirements of the code.
4. Be designed and constructed to resist flood loads and minimize transfer of flood loads to the building or structure, including foundation.

Areas below stairways and ramps shall not be enclosed with walls below the design flood elevation unless such walls are constructed in accordance with Section R322.3.5.

R322.3.8 Decks and porches. Attached decks and porches shall meet the elevation requirements of Section R322.3.2 and shall either meet the foundation requirements of this section or shall be cantilevered from or knee braced to the building or structure. Self-supporting decks and porches that are below the elevation required in Section R322.3.2 shall not be enclosed by solid, rigid walls, including walls designed to break away. Self-supporting decks and porches shall be designed and constructed to remain in place during base flood conditions or shall be frangible and break away under base flood conditions.

R322.3.9 Construction documents. The *construction documents* shall include documentation that is prepared and sealed by a registered *design professional* that the design and methods of construction to be used meet the applicable criteria of this section.

R322.3.10 Tanks. Underground tanks shall be anchored to prevent flotation, collapse and lateral movement under conditions of the base flood. Above-ground tanks shall be installed at or above the elevation required in Section R322.3.2. Where elevated on platforms, the platforms shall be cantilevered from or knee braced to the building or shall be supported on foundations that conform to the requirements of Section R322.3.

SECTION R323 STORM SHELTERS

R323.1 General. This section applies to storm shelters where constructed as separate detached buildings or where constructed as safe rooms within buildings for the purpose of providing refuge from storms that produce high winds, such as tornados and hurricanes. In addition to other applicable requirements in this code, storm shelters shall be constructed in accordance with ICC/NSSA-500.

SECTION R324 SOLAR ENERGY SYSTEMS

R324.1 General. Solar energy systems shall comply with the provisions of this section.

R324.2 Solar thermal systems. Solar thermal systems shall be designed and installed in accordance with Chapter 23 and the *International Fire Code*.

[W][S] R324.3 Photovoltaic systems. Installation, modification, or alteration of solar photovoltaic power systems shall comply with this section and the *International Fire Code*. Section R104.11 alternate materials and methods of this code shall be considered when approving the installation of solar photovoltaic power systems. Photovoltaic systems shall be designed and installed in accordance with Sections R324.3.1 through R324.7.1, (~~(NFPA 70)~~) the *Seattle Electrical Code*, and the manufacturer's installation instructions. Inverters shall be listed and labeled in accordance with UL 1741. Systems connected to the utility grid shall use inverters listed for utility interaction.

Exception: Detached, nonhabitable Group U structures shall not be subject to the requirements of this section for structural and life safety.

R324.3.1 Equipment listings. Photovoltaic panels and modules shall be listed and labeled in accordance with UL 1703. Inverters shall be *listed and labeled* in accordance with UL 1741. Systems connected to the utility grid shall use inverters *listed* for utility interaction.

[W] R324.4 Rooftop-mounted photovoltaic systems. Rooftop-mounted *photovoltaic panel systems* installed on or above the roof covering shall be designed and installed in accordance with (~~(this section)~~) Section R907.

Exceptions: The roof structure shall be deemed adequate to support the load of the rooftop solar photovoltaic system if all of the following requirements are met:

1. The solar photovoltaic panel system shall be designed for the wind speed of the local area, and shall be installed per the manufacturer's specifications.
2. The ground snow load does not exceed 70 pounds per square foot.
3. The total dead load of modules, supports, mountings, raceways, and all other appurtenances weigh no more than 4 pounds per square foot.
4. Photovoltaic modules are not mounted higher than 18 inches above the surface of the roofing to which they are affixed.
5. Supports for solar modules are to be installed to spread the dead load across as many roof-framing members as needed, so that no point load exceeds 50 pounds.

R324.4.1 Structural requirements. Rooftop-mounted *photovoltaic panel systems* shall be designed to structurally support the system and withstand applicable gravity loads in accordance with Chapter 3. The roof on which these systems are installed shall be designed and constructed to support the loads imposed by such systems in accordance with Chapter 8.

R324.4.1.1 Roof load. Portions of roof structures not covered with *photovoltaic panel systems* shall be designed for dead loads and roof loads in accordance with Sections R301.4 and R301.6. Portions of roof structures covered with *photovoltaic panel systems* shall be designed for the following load cases:

1. Dead load (including *photovoltaic panel* weight) plus snow load in accordance with Table R301.2(1).
2. Dead load (excluding *photovoltaic panel* weight) plus roof live load or snow load, whichever is greater, in accordance with Section R301.6.

R324.4.1.2 Wind load. Rooftop-mounted *photovoltaic panel* or *module* systems and their supports shall be designed and installed to resist the component and cladding loads specified in Table R301.2(2), adjusted for height and exposure in accordance with Table R301.2(3).

R324.4.2 Fire classification. Rooftop-mounted *photovoltaic panel systems* shall have the same fire classification as the roof assembly required in Section R902.

R324.4.3 Roof penetrations. Roof penetrations shall be flashed and sealed in accordance with Chapter 9.

R324.5 Building-integrated photovoltaic systems. Building-integrated photovoltaic systems that serve as roof coverings shall be designed and installed in accordance with Section R905.

R324.5.1 Photovoltaic shingles. Photovoltaic shingles shall comply with Section R905.16.

R324.5.2 Fire classification. *Building-integrated photovoltaic systems* shall have a fire classification in accordance with Section R902.3.

R324.6 Roof access and pathways. Roof access, pathways and setback requirements shall be provided in accordance with Sections R324.6.1 through R324.6.2.1. Access and minimum spacing shall be required to provide emergency access to the roof, to provide pathways to specific areas of the roof, provide for smoke ventilation opportunity areas, and to provide emergency egress from the roof.

Exceptions:

1. Detached, nonhabitable structures, including but not limited to detached garages, parking shade structures, carports, solar trellises and similar structures, shall not be required to provide roof access.
2. Roof access, pathways and setbacks need not be provided where the code official has determined that rooftop operations will not be employed.
3. These requirements shall not apply to roofs with slopes of two units vertical in 12 units horizontal (17-percent slope) or less.

R324.6.1 Pathways. Not fewer than two pathways, on separate roof planes from lowest roof edge to ridge and not less than 36 inches (914 mm) wide, shall be provided on all buildings. Not fewer than one pathway shall be provided on the street or driveway side of the roof. For each roof plane with a photovoltaic array, a pathway not less than 36 inches wide (914 mm) shall be provided from the lowest roof edge to ridge on the same roof plane as the photovoltaic array, on an adjacent roof plane, or straddling the same and adjacent roof planes. Pathways shall be over areas capable of supporting fire fighters accessing the roof. Pathways shall be located in areas with minimal obstructions such as vent pipes, conduit, or mechanical equipment.

R324.6.2 Setback at ridge. For photovoltaic arrays occupying not more than 33 percent of the plan view total roof area, not less than an 18-inch (457 mm) clear setback is required on both sides of a horizontal ridge. For photovoltaic arrays occupying more than 33 percent of the plan view total roof area, not less than a 36-inch (914 mm) clear setback is required on both sides of a horizontal ridge.

R324.6.2.1 Alternative setback at ridge. Where an automatic sprinkler system is installed within the dwelling in accordance with NFPA 13D or Section P2904, setbacks at ridges shall comply with one of the following:

1. For photovoltaic arrays occupying not more than 66 percent of the plan view total roof area, not less than an 18-inch (457 mm) clear setback is required on both sides of a horizontal ridge.
2. For photovoltaic arrays occupying more than 66 percent of the plan view total roof area, not less than a 36-inch (914 mm) clear setback is required on both sides of a horizontal ridge.

R324.6.2.2 Emergency escape and rescue opening. Panels and modules installed on dwellings shall not be placed on the portion of a roof that is below an emergency escape and rescue opening. A pathway not less than 36 inches (914 mm) wide shall be provided to the emergency escape and rescue opening.

R324.7 Ground-mounted photovoltaic systems. Ground-mounted photovoltaic systems shall be designed and installed in accordance with Section R301.

R324.7.1 Fire separation distances. Ground-mounted photovoltaic systems shall be subject to the *fire separation distance* requirements determined by the local *jurisdiction*.

SECTION R325 MEZZANINES

[W] R325.1 General. Mezzanines shall comply with Sections R325 through R325.5. *Habitable attics* shall comply with Section ((R325-6)) R326.

R325.2 Mezzanines. The clear height above and below mezzanine floor construction shall be not less than 7 feet (2134 mm).

R325.3 Area limitation. The aggregate area of a mezzanine or mezzanines shall be not greater than one-third of the floor area of the room or space in which they are located. The enclosed portion of a room shall not be included in a determination of the floor area of the room in which the *mezzanine* is located.

Exception: The aggregate area of a mezzanine located within a dwelling unit equipped with a fire sprinkler system in accordance with Section P2904 shall not be greater than one-half of the floor area of the room, provided that the mezzanine meets all of the following requirements:

1. Except for enclosed closets and bathrooms, the mezzanine is open to the room in which such mezzanine is located.

2. The opening to the room is unobstructed except for walls not more than 42 inches (1067 mm) in height, columns and posts.
3. The exceptions to Section R325.5 are not applied.

Interpretation R325.3: Only the following unenclosed areas of the room or space containing the *mezzanine* shall be used for purposes of calculating the allowable *mezzanine* floor area:

1. Areas with a ceiling height of at least 7 feet located directly below the *mezzanine*, except that no additional area benefit shall be gained for stacked *mezzanines*; and
2. Areas where the ceiling has a slope of less than 2:12 and with a ceiling height of at least 14 feet plus the thickness of the *mezzanine* floor construction; and
3. Areas where the ceiling has a slope of 2:12 or more and has a ceiling height of at least 12 feet plus the thickness of the *mezzanine* floor construction, provided that the *mezzanine* complies with Section 1208.2, exception 2.

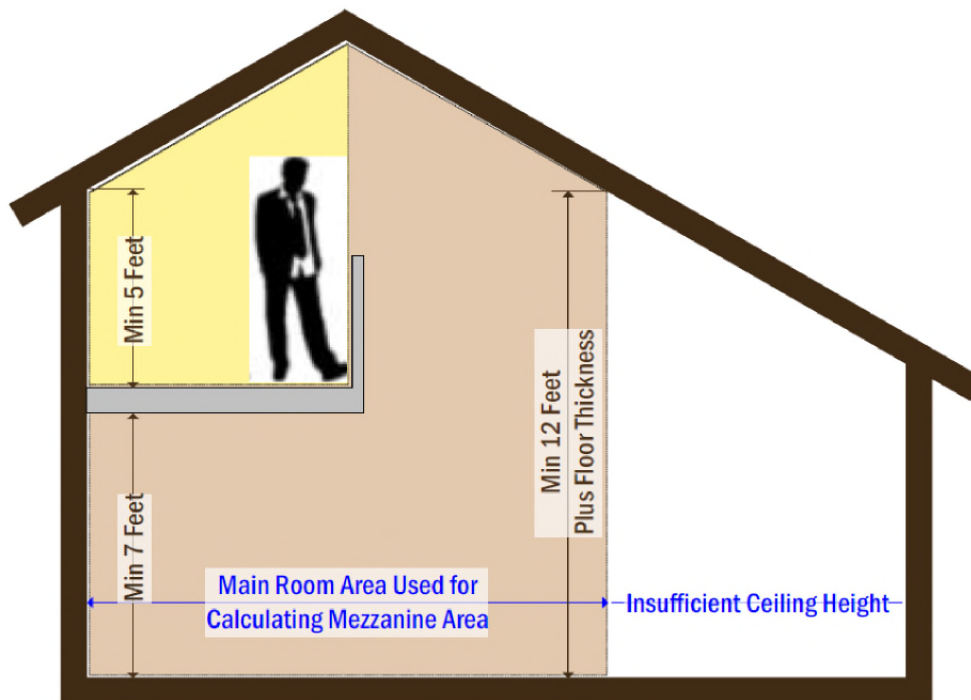

Basis for Calculating Allowable Mezzanine Area When Using Sloped Ceiling Provisions

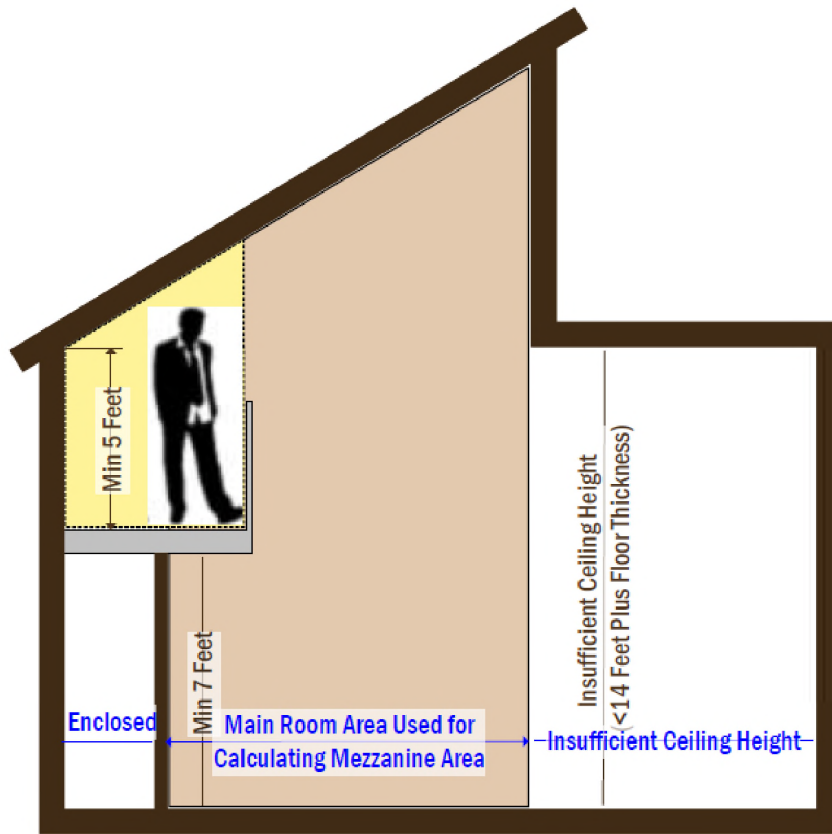

Basis for Calculating Allowable Mezzanine Area With Other Conditions

R325.4 Means of egress. The means of egress for mezzanines shall comply with the applicable provisions of Section R311.

[W] R325.5 Openness. Mezzanines shall be open and unobstructed to the room in which they are located except for walls not more than 36 inches (914 mm) in height, columns and posts.

Exceptions:

1. Mezzanines or portions thereof are not required to be open to the room in which they are located, provided that the aggregate floor area of the enclosed space is not greater than 10 percent of the mezzanine area.
2. ~~(In buildings)~~ **Mezzanines** that are not more than two stories above *grade plane* and equipped throughout with an automatic sprinkler system in accordance with Section R313, a mezzanine shall not be required to be open to the room in which the mezzanine is located.

[W] SECTION R326
HABITABLE ATTIC

R326.1 General. Habitable attics shall comply with Sections R326 through R326.4.

R326.2 Minimum Dimensions. A *habitable attic* shall have a minimum floor area in accordance with R304 and a ceiling height in accordance with R305.

R326.3 Story Above Grade Plane. A *habitable attic* shall be considered a story above grade plane.

Exception: A *habitable attic* shall not be considered a story above grade plane provided that the *habitable attic* meets all the following requirements:

1. The aggregate area of the *habitable attic* is not greater than one-half of the floor area of the story below.
2. The habitable attic is located within a dwelling unit equipped with a fire sprinkler system in accordance with Section P2904 or NFPA 13D.
3. The occupiable space is enclosed by the roof assembly above, knee walls (if applicable) on the sides and the floor-ceiling assembly below.
4. The floor of the *habitable attic* shall not extend beyond the exterior walls of the story below.

R326.4 Means of egress. The means of egress for *habitable attics* shall comply with the applicable provisions of Section R311.

[W] SECTION R327
SLEEPING LOFTS

R327.1 General. *Sleeping lofts* shall comply with Sections R327 through R327.5.

R327.2 Sleeping loft area and dimensions. *Sleeping lofts* shall meet the minimum area and dimension requirements of Sections R327.2.1 through R327.2.3.

R327.2.1 Area. *Sleeping lofts* shall have a floor area of not less than 35 square feet (3.25 m²) and less than 70 square feet (6.5 m²).

R327.2.2 Minimum horizontal dimensions. *Sleeping lofts* shall be not less than 5 feet (1524 mm) in any horizontal dimension.

R327.2.3 Height effect on sleeping loft area. Portions of a *sleeping loft* with a sloped ceiling measuring less than 3 feet (914 mm) from the finished floor to the finished ceiling shall not be considered as contributing to the minimum required area for the loft but shall contribute to the maximum allowable area.

Exception: Under gable roofs with a minimum slope of 6 units vertical in 12 units horizontal (50-percent slope), portions of a *sleeping loft* with a sloped ceiling measuring less than 16 inches (406 mm) from the finished floor to the finished ceiling shall not be considered as contributing to the minimum required area for the *sleeping loft* but shall contribute to the maximum allowable area.

R327.3 Sleeping loft access and egress. The access to and primary egress from *sleeping lofts* shall be of any type described in Sections R327.3.1 through R327.3.5 and shall meet the *sleeping loft* where the *sleeping loft's* ceiling height is not less than 3 feet (914 mm) along the entire width of the access and egress component.

R327.3.1 Stairways. Stairways accessing *sleeping lofts* shall comply with Sections R327.3.1.1 through R327.3.1.7.

R327.3.1.1 Headroom. The headroom above the *sleeping loft* access and egress shall be not less than 6 feet 2 inches (1880 mm), as measured vertically, from a sloped line connecting the tread, landing, or landing platform nosing's in the center of their width, and vertically from the landing or landing platform along the center of its width.

R327.3.1.2 Width. Stairways accessing a *sleeping loft* shall not be less than 17 inches (432 mm) in clear width at or above the handrail. The width below the handrail shall be not less than 20 inches (508 mm).

R327.3.1.3 Treads and risers. Risers for stairs accessing a *sleeping loft* shall be not less than 7 inches (178 mm) and not more than 12 inches (305 mm) in height. Tread depth and riser height shall be calculated in accordance with one of the following formulas:

1. Under gable roofs with a minimum slope of 6 units vertical in 12 units horizontal (50-percent slope), portions of a *sleeping loft* with a sloped ceiling measuring less than 16 inches (406 mm) from the finished floor to the finished ceiling shall not be considered as contributing to the minimum required area for the *sleeping loft* but shall contribute to the maximum allowable area.
2. The tread depth shall be 20 inches (508 mm) minus four-thirds of the riser height.

R327.3.1.4 Landings. Intermediate landings and landings at the bottom of stairways shall comply with Section R311.7.6, except that the depth in the direction of travel shall be not less than 24 inches (508 mm).

R327.3.1.5 Landing platforms. The top tread and riser of stairways accessing *sleeping lofts* shall be constructed as a landing platform where the loft ceiling height is less than 6 feet 2 inches (1880 mm) where the stairway meets the *sleeping loft*. The landing platform shall be not less than 18 inches (508 mm) in width and in depth measured horizontally from and perpendicular to the nosing of the landing platform. The landing platform riser height to the edge of the *sleeping loft* floor, shall not be greater than 18 inches (406 to 457 mm) in height.

R327.3.1.6 Handrails. Handrails shall comply with Section R311.7.8.

R327.3.1.7 Stairway guards. Guards at open sides of stairways, landings, and landing platforms shall comply with Section R312.1. **R327.3.2 Ladders.** Ladders accessing *sleeping lofts* shall comply with Sections R327.3.2.1 and R327.3.2.2.

R327.3.2 Ladders. Ladders accessing *sleeping lofts* shall comply with Sections R327.3.2.1 and R327.3.2.2.

R327.3.2.1 Size and capacity. Ladders accessing *sleeping lofts* shall have a rung width of not less than 12 inches (305 mm), and 10-inch (254 mm) to 14-inch (356 mm) spacing between rungs. Ladders shall be capable of supporting a 300 pound (136 kg) load on any rung. Rung spacing shall be uniform within 3/8 inch (9.5 mm).

R327.3.2.2 Incline. Ladders shall be installed at 70 to 80 degrees from horizontal.

R327.3.3 Alternating tread devices. Alternating tread devices accessing *sleeping lofts* shall comply with Sections R311.7.11.1 and R311.7.11.2. The clear width at and below the handrails shall be not less than 20 inches (508 mm).

R327.3.4 Ships ladders. Ships ladders accessing *sleeping lofts* shall comply with Sections R311.7.12.1 and R311.7.12.2. The clear width at and below handrails shall be not less than 20 inches (508 mm).

R327.4 Sleeping loft guards. *Sleeping loft* guards shall be located along the open side(s) of *sleeping lofts*. *Sleeping loft* guards shall be not less than 36 inches (914 mm) in height or one-half of the clear height to the ceiling, whichever is less. *Sleeping loft* guards shall comply with Section R312.1.3 and Table R301.5 for their components.

R327.5 Emergency escape and rescue openings. An egress roof access window shall be installed in each *sleeping loft* and shall be deemed to meet the requirements of Section R310 where installed such that the bottom of the opening is not more than 44 inches (1118 mm) above the *sleeping loft* floor, provided the egress roof access window complies with the minimum opening area requirements of Section R310.2.1.

[W] SECTION ((R326)) R328 SWIMMING POOLS, SPAS AND HOT TUBS

((~~R326.1~~) **R328.1 General.** The design and construction of pools and spas shall comply with the 2018 International Swimming Pool and Spa Code ((-)) if the facility is one of the following:

1. For the sole use of residents and invited guests at a single-family dwelling;
2. For the sole use of residents and invited guests of a duplex owned by the residents; or
3. Operated exclusively for physical therapy or rehabilitation and under the supervision of a licensed medical practitioner.

[W] SECTION ((R327)) R329 ((STATIONARY)) ENERGY STORAGE ((BATTERY)) SYSTEMS

((~~R327.1~~) **R329.1 General.** ((~~Stationary storage battery system~~)) Energy Storage Systems (ESS) shall comply with the provisions of this section.

((~~R327.2~~) **R329.2 Equipment listings.** ((~~Stationary storage battery systems~~)) ESS shall be *listed* and *labeled* for residential use in accordance with UL 9540.

Exceptions:

1. Where *approved*, repurposed unlisted battery systems from electric vehicles are allowed to be installed outdoors or in detached sheds located not less than 5 feet (1524 mm) from exterior walls, property lines and public ways.
2. *Battery systems* that are an integral part of an electric vehicle are allowed provided that the installation complies with Section 625.48 of NFPA 70.
3. Battery systems less than 1 kWh (3.6 megajoules).

((~~R327.3~~) **R329.3 Installation.** ((~~Stationary storage battery systems~~)) ESS shall be installed in accordance with the manufacturer's instructions and their *listing*, if applicable, and shall not be installed within the habitable space of a dwelling unit.

~~(R327.4)~~ **R329.4 Electrical installation.** ~~((Stationary storage battery systems))~~ ESS shall be installed in accordance with NFPA 70. Inverters shall be *listed* and *labeled* in accordance with UL 1741 or provided as part of the UL 9540 listing. Systems connected to the utility grid shall use inverters listed for utility interaction.

~~(R327.5)~~ **R329.5 Ventilation.** Indoor installations of ~~((stationary storage battery systems))~~ ESS that include batteries that produce hydrogen or other flammable gases during charging shall be provided with ventilation in accordance with Section M1307.4.

~~(R327.6)~~ **R329.6 Protection from impact.** ~~((Stationary storage battery systems))~~ ESS installed in a location subject to vehicle damage shall be protected by approved barriers.

R329.7 Commissioning. ESS shall be commissioned as follows:

1. Verify that the system is installed in accordance with the approved plans and manufacturer's instructions and is operating properly.
2. Provide a copy of the manufacturer's installation, operation, maintenance, and decommissioning instructions provided with the listed system.
3. Provide a label on the installed system containing the contact information for the qualified maintenance and service providers.

R329.7.1 Installation prior to closing. Where the system is installed in a one- or two-family dwelling or townhouse that is owned by the builder and has yet to be sold, commissioning shall be conducted as outlined in Section R329.7, and the builder shall then transfer the required information in Section R329.7 to the homeowner when the property is transferred to the owner at the closing.

[W] SECTION R330 ADULT FAMILY HOMES

R330.1 General. This section shall apply to all newly constructed *adult family homes* and all existing single family homes being converted to *adult family homes*. This section shall not apply to those *adult family homes* licensed by the state of Washington Department of Social and Health Services prior to July 1, 2001.

R330.2 Sleeping room classification. Each sleeping room in an *adult family home* shall be classified as:

1. Type S - Where the means of egress contains stairs, elevators or platform lifts.
2. Type NS1 - Where one means of egress is at grade level or a ramp constructed in accordance with Section R330.8 is provided.
3. Type NS2 - Where two means of egress are at grade level or ramps constructed in accordance with Section R330.8 are provided.

R330.3 Types of locking devices and door activation. All bedroom and bathroom doors shall be openable from the outside when locked.

Every closet shall be readily openable from the inside.

Operable parts of door handles, pulls, latches, locks and other devices installed in *adult family homes* shall be operable with one hand and shall not require tight grasping, pinching or twisting of the wrist.

Pocket doors shall have graspable hardware available when in the closed or open position.

The force required to activate operable parts shall be 5.0 pounds (22.2 N) maximum. Required exit doors shall have no additional locking devices.

Required exit door hardware shall unlock inside and outside mechanisms when exiting the building allowing reentry into the *adult family home* without the use of a key, tool or special knowledge.

R330.4 Smoke and carbon monoxide alarm requirements. All *adult family homes* shall be equipped with smoke and carbon monoxide alarms installed as required in Sections R314 and R315. Alarms shall be installed in such a manner so that the detection device warning is audible from all areas of the *dwelling* upon activation of a single alarm.

R330.5 Escape windows and doors. Every sleeping room shall be provided with emergency escape and rescue windows as required by Section R310. No alternatives to the sill height such as steps, raised platforms or other devices placed by the openings will be *approved* as meeting this requirement.

R330.6 Fire apparatus access roads and water supply for fire protection. *Adult family homes* shall be served by fire apparatus access roads and water supplies meeting the requirements of the *International Fire Code*.

R330.7 Grab bar general requirements. Where facilities are designated for use by *adult family home* clients, grab bars for water closets, bathtubs and shower stalls shall be installed according to this section.

R330.7.1 Grab bar cross section. Grab bars with a circular cross section shall have an outside diameter of 1-1/4 inches minimum and 2 inches maximum. Grab bars with noncircular cross section shall have a cross section dimension of 2 inches maximum and a perimeter dimension of 4 inches minimum and 4-5/8 inches maximum.

R330.7.2 Grab bar installation. Grab bars shall have a spacing of 1-1/2 inches between the wall and the bar. Projecting objects, control valves and bathtub or shower stall enclosure features above, below and at the ends of the grab bar shall have a clear space of 1-1/2 inches to the grab bar.

Exception: Swing-up grab bars shall not be required to meet the 1-1/2 inch spacing requirement. Grab bars shall have a structural strength of 250 pounds applied at any point on the grab bar, fastener, mounting device or supporting structural member. Grab bars shall not be supported directly by any residential grade fiberglass bathing or showering unit. Acrylic bars found in bathing units shall be removed. Fixed position grab bars, when mounted, shall not rotate, spin or move, and shall have a graspable surface finish.

R330.7.3 Grab bars at water closets. Water closets shall have grab bars mounted on both sides. Grab bars can be a combination of fixed position and swing-up bars. Grab bars shall meet the requirements of Section R330.7. Grab bars shall mount between 33 inches and 36 inches above floor grade. Centerline distance between grab bars, regardless of type used, shall be between 25 inches minimum and 30 inches maximum.

R330.7.3.1 Fixed position grab bars. Fixed position grab bars shall be at least 36 inches in length and start 12 inches from the rear wall.

R330.7.3.2 Swing-up grab bars. Swing-up grab bars shall be a minimum of 28 inches in length from the rear wall.

R330.7.4 Grab bars at bathtubs. Horizontal and vertical grab bars shall meet the requirements of Section R330.8.

R330.7.4.1 Vertical grab bars. Vertical grab bars shall be a minimum of 18 inches long and installed at the control end wall and head end wall. Grab bars shall be mounted within 4 inches of the exterior of the bathtub edge or within 4 inches within the bathtub. The bottom end of the bar shall start between 36 inches and 42 inches above floor grade.

Exception: The required vertical grab bar can be substituted with a floor to ceiling grab bar meeting the requirements of Section R330.7 at the control end and head end entry points.

R330.7.4.2 Horizontal grab bars. Horizontal grab bars shall be provided at the control end, head end, and the back wall within the bathtub area. Grab bars shall be mounted between 33 inches and 36 inches above floor grade. Control end and head end grab bars shall be at least 24 inches in length. Back wall grab bars shall be at least 36 inches in length.

R330.7.5 Grab bars at shower stalls. Where shower stalls are provided to meet the requirements for bathing facilities, grab bars shall meet the requirements of Section R330.7.

Exception: Shower stalls with permanent built-in seats are not required to have vertical or horizontal grab bars at the seat end wall. A vertical floor to ceiling grab bar shall be installed within 4 inches of the exterior of the shower aligned with the nose of the built-in seat.

R330.7.5.1 Vertical grab bars. Vertical grab bars shall be at least 18 inches in length and installed at the control end wall and head end wall. Vertical bars shall mount within 4 inches of the exterior of the shower stall or within 4 inches inside the shower stall. The bottom end of vertical bars shall be mounted between 36 inches and 42 inches above floor grade.

R330.7.5.2 Horizontal grab bars. Horizontal grab bars shall be installed on all sides of the shower stall mounted between 33 inches and 36 inches above the floor grade. Horizontal grab bars shall be a maximum of 6 inches from adjacent walls. Horizontal grab bars shall not interfere with shower control valves.

R330.8 Ramps. All interior and exterior ramps, when provided, shall be constructed in accordance with Section R311.8 with a maximum slope of 1 vertical to 12 horizontal. The exception to Section R311.8.1 is not allowed for *adult family homes*. Handrails shall be installed in accordance with Section R330.8.1.

R330.8.1 Handrails for ramps. Handrails shall be installed on both sides of ramps between the slope of 1 vertical to 12 horizontal and 1 vertical and 20 horizontal in accordance with Sections R311.8.1 through R311.8.3.3.

R330.9 Stair treads and risers. Stair treads and risers shall be constructed in accordance with Section R311.7.5. Handrails shall be installed in accordance with Section R330.9.1.

R330.9.1 Handrails for treads and risers. Handrails shall be installed on both sides of treads and risers numbering from one riser to multiple risers. Handrails shall be installed in accordance with Sections R311.7.8 through R311.7.8.4.

R330.10 Shower stalls. Where provided to meet the requirements for bathing facilities, the minimum size of shower stalls for *adult family homes* shall be 30 inches deep by 48 inches long.

**[W] SECTION R331
FAMILY HOME CHILD CARE**

R331.1 Family home child care. For *family home child care* with more than six children, each floor level used for family child care purposes shall be served by two remote means of egress. Exterior exit doors shall be operable from the inside without the use of keys or any special knowledge or effort.

R331.1.1 Basement egress. *Basements* located more than 4 feet (1219 mm) below grade level shall not be used for *family home child care* unless one of the following conditions exist:

1. Stairways from the *basement* open directly to the exterior of the building without entering the first floor; or
2. One of the two required means of egress discharges directly to the exterior from the *basement* level, and a self-closing door is installed at the top or bottom of the interior stair leading to the floor above; or
3. One of the two required means of egress is an operable window or door, *approved* for emergency escape or rescue, that opens directly to a public street, public alley, *yard* or exit court; or
4. A residential sprinkler system is provided throughout the entire building in accordance with NFPA 13D.

R331.1.2 Floors above grade. Floors located more than 4 feet above grade level shall not be occupied by children in *family home child care*.

Exceptions:

1. Use of toilet facilities while under supervision of an adult staff person.
2. *Family home child care* may be allowed on the second story if one of the following conditions exists:
 - 2.1. Stairways from the second story open directly to the exterior of the building without entering the first floor; or
 - 2.2. One of the two required means of egress discharges directly to the exterior from the second story level, and a self-closing door is installed at the top or bottom of the interior stair leading to the floor below; or
 - 2.3. A residential sprinkler system is provided throughout the entire building in accordance with NFPA 13D.

R331.2 Emergency escape and rescue. Every sleeping or napping room in a *family home child care* shall have at least one operable window for emergency rescue.

Exception: Sleeping or napping rooms having doors leading to two separate means of egress, or a door leading directly to the exterior of the building.

R331.3 Special hazards. Rooms or spaces containing a commercial-type cooking kitchen, boiler, maintenance shop, janitor closet, laundry, woodworking shop, flammable or combustible storage, or painting operation shall be separated from the *family home child care* area by at least one-hour fire-resistance-rated construction.

Exception: A fire-resistance-rated separation is not required where the food preparation kitchen contains only a domestic cooking range, and the preparation of food does not result in the production of smoke or grease-laden vapors.

**SECTION R332
FLOATING HOMES**

R332.1 Moorage location. Every *floating home moorage* shall be located on privately-owned or privately-controlled premises in accordance with the Land Use Code, Title 23 of the *Seattle Municipal Code*.

R332.2 Land access. Every *floating home moorage* shall have not less than 20 feet (6096 mm) of land frontage abutting a public street sufficiently improved for automobile travel.

R332.3 Moorage walkways. Every *floating home moorage* shall have firm and substantial walkways with a net width of not less than 4 feet (1219 mm) and extending from land to every *floating home site* in the moorage.

R332.4 Moorage lighting. Every *floating home moorage* and the walkways to every *floating home site* shall be illuminated to provide safe access. All luminaires shall be *listed* for the use.

R332.5 Fire protection. *Floating home moorages* shall be provided with fire extinguishing *equipment* as follows:

1. Portable fire-protection *equipment*. One fire extinguisher, 2A, 20-B:C rating minimum, shall be provided in each required hose station. The fire chief shall designate the type and number of all other fire *appliances* to be installed and maintained in each *floating home moorage*.
2. Standpipes. All portions of floats exceeding 250 feet (76 500 mm) in distance from fire apparatus access and marine service stations shall be provided with an *approved* Class I standpipe system installed according to International Building Code Section 905 and the *International Fire Code*.

R332.6 Water service connections. Every *floating home moorage* shall have a water service connection and shall provide water service *piping* securely fastened and stabilized above water from the water service connection to an outlet connection at each

floating home site on a floating home moorage. The water piping in every floating home in a floating home moorage shall be connected to the water service outlet serving the floating home and the connection shall be securely fastened and stabilized above high water line. Water service connections and water service piping shall be constructed, installed and maintained in accordance with applicable standards established by or pursuant to ordinance.

R332.7 Public sewer connection. Every floating home moorage any part of which is within 300 feet (91 440 mm) of a public sewer and every floating home moorage on Shilshole Bay, Salmon Bay, Lake Washington Ship Canal, Lake Union, Portage Bay, Union Bay and that portion of Lake Washington lying within the city limits of Seattle shall have a lawfully-installed connection to a public sewer.

R332.8 Local side sewer system. Every floating home moorage within the limits specified in Section R332.7 shall provide a local side sewer system for the collection of sewage from every floating home in the moorage. The local side sewer system shall be connected to the public sewer, shall have an inlet connection at each floating home site and shall be constructed, installed and maintained in accordance with this and all other applicable ordinances regulating the construction, alteration, repair and connection of side sewers.

R332.9 Connection to local side sewer system. Every floating home in a floating home moorage that is required under Section R332.7 to be connected to a public sewer shall be connected to the local side sewer system. Owners and operators of floating home moorages shall not permit any floating home to be moored at any moorage under their control unless the floating home is connected to the local side sewer system. It is a violation for any person to use, occupy or let any floating home for human habitation within the limits specified in Section R332.7 unless it is connected to the sewer system.

A reconnection permit is required for any floating home that is relocated from its original site of connection to a local side sewer system. Such reconnection is subject to the approval of the Director of Seattle Public Utilities.

R332.10 Sewer installation fees. The fee for the installation of any side sewer serving a floating home moorage is the fee provided by law for the connection to the public sewer of side sewers serving mobile home parks.

R332.11 Plumbing systems. All plumbing and plumbing systems in every floating home shall meet the requirements of the Uniform Plumbing Code except as otherwise approved by the Director of Public Health.

R332.12 Garbage disposal. Every floating home moorage shall be provided with adequate garbage storage and collection facilities, which shall be located in an accessible place on the moorage site. No garbage or refuse shall be thrown or dumped into the waters.

R332.13 Electrical service and wiring. Electrical service approved by City Light shall be provided to floating homes and floating home moorages. Electrical wiring and equipment in every floating home shall conform to requirements of the Seattle Electrical Code. No floating home shall be permitted to connect or reconnect to the electric utility's distribution system unless approved for such connection by the building official in accordance with the Seattle Electrical Code.

R332.14 Housing standards for existing floating homes. Every floating home shall comply with the minimum housing standards of the Seattle Housing and Building Maintenance Code except as otherwise approved by the building official in accordance with the Housing and Building Maintenance Code.

R332.15 Property lines. The boundaries of floating home moorage sites shall be considered the lot line for determining compliance with Section R302.

Interpretation R332.15: For the purposes of determining the required wall and opening protection and roof-covering requirements, distance shall be measured to the exterior wall of the home, and not to the float.

R332.16 Approval of moorage site plan required. Every floating home moorage shall continuously conform to a moorage site plan that has been approved by the building official. Such approval shall be obtained as follows: Three copies of the site plan, drawn to scale and completely dimensioned, and setting forth the address and legal description of the property on which the moorage is located and the name and address of the owner or operator of the moorage, shall be filed with the building official.

The moorage site plan shall show:

1. The dimensions of the floating home moorage site;
2. The location of abutting public waterways;
3. The location and dimensions of private waterways and land access to the moorage;
4. The location and identification of individual floating home sites;
5. The location and dimensions of off-street parking spaces;
6. The location and dimensions of walkways and any accessory structures or facilities;
7. The water service system;
8. The local side sewer system; and

9. The electrical service and lighting system.

The site plan shall be reviewed by the code official, the Fire Chief, the Director of Public Health, the Director of Seattle Public Utilities and the Director of Transportation for conformance with the requirements of this code and other applicable ordinances. Upon approval by the *building official*, one copy of the *approved* site plan shall be retained in the office of the *building official*, one copy in the office of the Director of Public Health and one copy, which shall be maintained on the premises of the *floating home moorage*, shall be returned to the owner or operator.

R332.17 Moorage register of ownership. Every owner or operator of a *floating home moorage* shall maintain a current register of every *floating home* moored on the premises, such register to record the name and address of the legal owner of each *floating home* and the registration number assigned to it by the King County Assessor. A copy of the register shall be made available upon request to any City department referred to in this chapter.

[S] SECTION R333
SECURITY FROM CRIMINAL ACTIVITY

R333.1 Building entrance locks. Building entrance doors, including garage doors, shall be capable of locking. They shall be equipped with a dead-locking latch bolt with at least a 1/2 inch throw that penetrates the striker not less than 1/4 inch. Building entrance doors shall be openable from the inside without use of a key or special knowledge or effort.

Exception: Garage-to-exterior doors are permitted to be equipped with an electronically-operated remote control device for opening and closing in lieu of a dead-locking latch bolt. When garage-to-exterior doors are equipped with remote control devices, garage-to-building doors need not be capable of locking.

R333.2 Observation ports. Every building entrance door, other than garage doors, shall have a visitor observation port or glass side light. Observation ports shall be installed at a height of not less than 54 inches (1372 mm) and not more than 66 inches (1676 mm) from the floor.

R333.3 Windows and sliding doors. Dead bolts or other *approved* locking devices shall be provided on all sliding doors and openable windows. The lock shall be installed so that the mounting screws for the lock case are inaccessible from the outside.

Exception: Windows with sills located 10 feet (3048 mm) or more above grade, or 10 feet or more above a deck, balcony or porch that is not *readily accessible* from grade except through a housing unit need not have operable inside latching devices.

R333.4 Alternate security devices. Subject to the approval of the *building official*, alternate security devices are permitted to be substituted for those required by this section. Alternate devices must have equal capability to resist illegal entry. The installation of the device shall not conflict with other requirements of this code and other ordinances regulating the safety of exiting.

[S] SECTION R334
SOUND TRANSMISSION CONTROL

R334.1 General. Wall and floor-ceiling assemblies separating *dwelling units* shall provide sound insulation in accordance with this Section R334.

R334.1.1 Perimeter joints. Joints in the perimeter of such separating wall or floor-ceiling assembly shall be acoustically sealed with a permanent resilient material *approved* for the purpose. The separating wall or floor-ceiling assembly shall extend completely to and be sealed to another separating assembly or an *exterior wall*, roof or floor assembly.

R334.1.2 Penetrations. Conduits, ducts, pipes and vents within the wall or floor-ceiling assembly causing vibration shall be reasonably isolated from the building construction at points of support by means of resilient sleeves, mounts or underlayments. All other openings through which such conduits, ducts, pipes or vents pass shall have the excess opening fully sealed with insulative and permanently resilient materials *approved* for the purpose.

R334.1.3 Fire-resistance ratings. Design and materials for sound transmission control shall not impair the fire-resistance rating of separating walls or floor-ceiling assemblies required to be of fire-resistance-rated construction.

R334.2 Airborne sound. Airborne sound insulation for wall and floor-ceiling assemblies shall meet a Sound Transmission Class (STC) rating of 45 when tested in accordance with ASTM E 90.

R334.2.1 Outlet boxes. Electrical outlet boxes shall not be placed back-to-back and shall be offset by not less than 12 inches (305 mm) from outlets in the opposite wall surface. The back and sides of boxes shall be sealed with 1/8 inch resilient sealant and backed by a minimum of 2 inch thick mineral fiber insulation or *approved* equivalent.

R334.3 Structural-borne sound. Floor-ceiling assemblies between *dwelling units* or between a *dwelling unit* and a public or service area within a structure shall have an Impact Insulation Class (IIC) rating of not less than 50 when tested in accordance with ASTM E 492. Floor covering may be included in the assembly to obtain the required ratings.

Exception: Floor assemblies in bathrooms are not required to meet the IIC rating of 50 where structural concrete floor systems are used.

R334.4 Tested assemblies. Field- or laboratory-tested wall or floor-ceiling designs having an STC or IIC of 50 or more may be used without additional field testing when, in the opinion of the *building official*, the tested design has not been compromised by flanking paths. Tests may be required by the *building official* when evidence of compromised separations is noted. Wall or floor-ceiling designs field tested by ASTM E 336 having a minimum FSTC or FIIC rating of 45 may be used.

R334.5 Field testing and certification. Field testing, when permitted to determine airborne sound transmission or impact sound insulation class, shall be done in accordance with ASTM E 492 under the supervision of an acoustical professional who is experienced in the field of acoustical testing and engineering and who shall forward certified test results to the *building official* that minimum sound insulation requirements stated above have been met.

R334.6 Sound transmission control systems. Generic systems *listed* in GA 600 may be accepted where a laboratory test indicates that the requirements of Section R334 are met by the system.

